



Antenna Datasheet

Product OC: YEMX425J1A

Version: 1.0

Date: 2023-06-19

Status: Released

Product Name: 5G × 4 Combo Antenna

Key Features:

Frequency Band: 410–470 MHz, 617–2690 MHz, 3300–6000 MHz

Dimensions: 186 × 176 × 150 mm

Efficiency: Up to 76.2 % (4G/5G-1)

RoHS and REACH Compliant

IP67

Overview

This ultra-wide-band 5G/4G antenna box provides broad coverage from 410–6000 MHz whilst backward-compatible to support 3G/2G networks as well as Cat-M and NB-IoT. The antenna is designed for ease of integration with connection via 4 various cable lengths from 50–5000 mm, terminated with SMA connectors. This pole/wall/suction mount omni-directional antenna is easy to install with maximum durability with its IP67 & IP69K ASA enclosure. It is compatible with Quectel's RM520x Series modules. Quectel provides comprehensive antenna design support such as simulation, testing and manufacturing for custom antenna solutions to meet your specific application needs.

Contents

Overview	1
Contents	2
1 Specification	3
1.1. Electrical.....	3
1.1.1. 4G/5G-1.....	3
1.1.2. 4G/5G-2.....	4
1.1.3. 4G/5G-3.....	4
1.1.4. 4G/5G-4.....	5
1.2. Mechanical & Environmental	6
2 Drawing	7
3 Detailed Performance	8
3.1. S-Parameter Test	8
3.1.1. VSWR.....	8
3.1.2. Return Loss	9
3.1.3. Isolation	10
3.2. Radiation Performance Test.....	11
3.2.1. Efficiency	11
3.2.2. Average Gain	12
3.2.3. Peak Gain.....	13
3.2.4. 3D & 2D Radiation Pattern.....	14
4 Packaging	35
Contact Us	37
Legal Notices	38
Revision History	40

1 Specification

Test Condition: Free Space

1.1. Electrical

Electrical	
Frequency Range	410–470 MHz, 617–2690 MHz, 3300–6000 MHz
Radiation Pattern	Omni-directional
Polarization	Linear
Impedance	50 Ω
Isolation	≤ -8.8dB

1.1.1. 4G/5G-1

Electrical - Detail													
Band	Band	B31/ B88	B71	B12 /B13 /B28	B5 /B8 /B26	N74 /N75 /N76	B1 /B2 /B3	B40	Wi-Fi 2G	B38 /B41	B42 /B48 /N77	N79	Wi-Fi 5G
	SPEC	Freq. (MHz)	410- 470	610- 700	700- 810	820- 960	1420- 1520	1700- 2170	2300- 2400	2400- 2500	2500- 2690	3300- 4200	4400- 5000
Max. VSWR		3.5	4.6	3.9	3.0	2.8	2.1	1.6	1.7	1.8	2.1	1.6	2.0
Max. Return Loss (dB)		-5.2	-3.8	-4.6	-6.1	-6.4	-9.2	-12.8	-12.0	-10.6	-9.0	-12.9	-9.8
AVG Eff. (%)		23.1	33.7	52.7	57.5	43.0	58.4	66.6	56.5	59.1	66.7	69.9	62.3
AVG AVG Gain (dB)		-6.4	-4.7	-2.8	-2.4	-3.7	-2.3	-1.8	-2.5	-2.3	-1.8	-1.6	-2.1
Max. Peak Gain (dBi)		-0.5	1.2	5.6	5.6	4.8	3.5	3.9	3.5	4.2	3.6	4.9	3.0
VSWR		≤ 4.6											

Return Loss	≤ -3.8 dB
Peak Gain	≤ 5.6 dBi

1.1.2. 4G/5G-2

Electrical - Detail													
Band	Band	B31/ B88	B71	B12 /B13 /B28	B5 /B8 /B26	N74 /N75 /N76	B1 /B2 /B3	B40	Wi-Fi 2G	B38 /B41	B42 /B48 /N77	N79	Wi-Fi 5G
	SPEC	Freq. (MHz)	410- 470	610- 700	700- 810	820- 960	1420- 1520	1700- 2170	2300- 2400	2400- 2500	2500- 2690	3300- 4200	4400- 5000
Max. VSWR		6.2	4.1	2.6	2.2	3.0	2.6	1.4	1.4	2.1	2.2	1.7	1.9
Max. Return Loss (dB)		-2.8	-4.4	-7.0	-8.6	-6.1	-7.2	-14.9	-16.5	-9.0	-8.7	-11.7	-10.3
AVG Eff. (%)		26.0	27.7	41.7	48.6	38.2	53.3	66.4	56.0	56.6	64.1	64.6	62.6
AVG AVG Gain (dB)		-5.8	-5.6	-3.8	-3.1	-4.2	-2.7	-1.8	-2.5	-2.5	-1.9	-1.9	-2.0
Max. Peak Gain (dBi)		-0.3	2.2	4.9	4.4	4.0	4.8	2.5	4.7	4.7	5.3	4.4	4.0
VSWR							≤ 6.2						
Return Loss							≤ -2.8 dB						
Peak Gain							≤ 5.3 dBi						

1.1.3. 4G/5G-3

Electrical - Detail													
Band	Band	B31/ B88	B71	B12 /B13 /B28	B5 /B8 /B26	N74 /N75 /N76	B1 /B2 /B3	B40	Wi-Fi 2G	B38 /B41	B42 /B48 /N77	N79	Wi-Fi 5G
	SPEC	Freq. (MHz)	410- 470	610- 700	700- 810	820- 960	1420- 1520	1700- 2170	2300- 2400	2400- 2500	2500- 2690	3300- 4200	4400- 5000
Max. VSWR		5.1	4.6	3.1	2.6	2.6	2.3	1.5	1.5	2.2	2.2	1.7	1.9
Max. Return Loss (dB)		-3.4	-3.9	-5.8	-7.1	-6.9	-8.1	-13.7	-14.6	-8.3	-8.4	-11.4	-10.0

AVG Eff. (%)	27.3	30.8	48.7	54.6	52.2	54.6	67.1	64.4	54.5	66.9	63.5	62.6
AVG AVG Gain (dB)	-5.6	-5.1	-3.1	-2.6	-2.8	-2.6	-1.7	-1.9	-2.6	-1.7	-2.0	-2.0
Max. Peak Gain (dBi)	-0.5	0.2	1.8	3.1	3.1	4.8	2.7	4.6	5.1	6.2	5.0	3.7
VSWR	≤ 5.1											
Return Loss	≤ -3.4 dB											
Peak Gain	≤ 6.2 dBi											

1.1.4. 4G/5G-4

Electrical - Detail													
Band	Band	B31/ B88	B71	B12 /B13 /B28	B5 /B8 /B26	N74 /N75 /N76	B1 /B2 /B3	B40	Wi-Fi 2G	B38 /B41	B42 /B48 /N77	N79	Wi-Fi 5G
	SPEC	Freq. (MHz)	410- 470	610- 700	700- 810	820- 960	1420- 1520	1700- 2170	2300- 2400	2400- 2500	2500- 2690	3300- 4200	4400- 5000
Max. VSWR		5.4	5.3	3.7	3.2	3.2	2.0	1.6	1.7	2.3	2.1	1.7	1.8
Max. Return Loss (dB)		-3.2	-3.3	-4.8	-5.7	-5.7	-9.4	-12.3	-11.8	-8.2	-9.1	-11.9	-10.7
AVG Eff. (%)		23.3	33.4	62.4	60.9	44.8	59.7	66.9	55.3	53.9	65.9	63.9	59.1
AVG AVG Gain (dB)		-6.3	-4.8	-2.0	-2.2	-3.5	-2.2	-1.7	-2.6	-2.7	-1.8	-1.9	-2.3
Max. Peak Gain (dBi)		0.4	1.4	3.1	3.5	2.8	5.3	4.3	4.4	4.2	5.1	3.2	3.7
VSWR							≤ 5.4						
Return Loss							≤ -3.2 dB						
Peak Gain							≤ 5.3 dBi						

1.2. Mechanical & Environmental

Mechanical	
Antenna Dimensions	186 × 176 × 150 mm
Antenna Material & Color	ASA
Cable Type & Color & Length	ALSR200 & Black & 450 mm
Connector Type	SMA Male
Weight	Typ. 650 g
Mounting Type	pole /wall /suction cup
Environmental	
Operation Temperature	-40 °C to +85 °C
Storage Temperature	-40 °C to +85 °C
Ingress Protection (IP) Rating	IP67
RoHS & REACH Compliant	Yes

2 Drawing

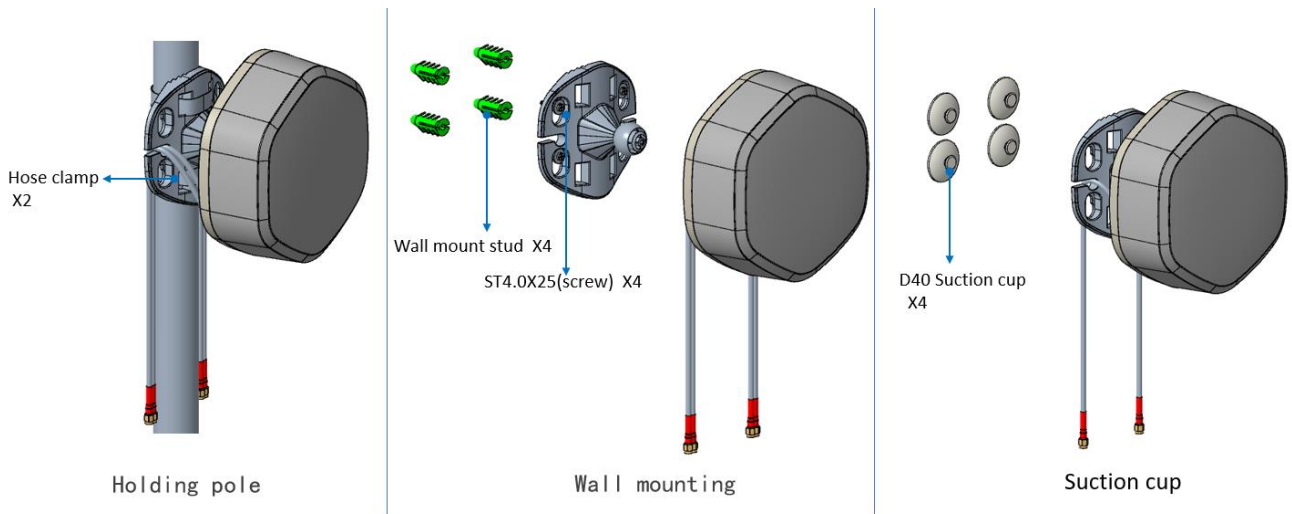
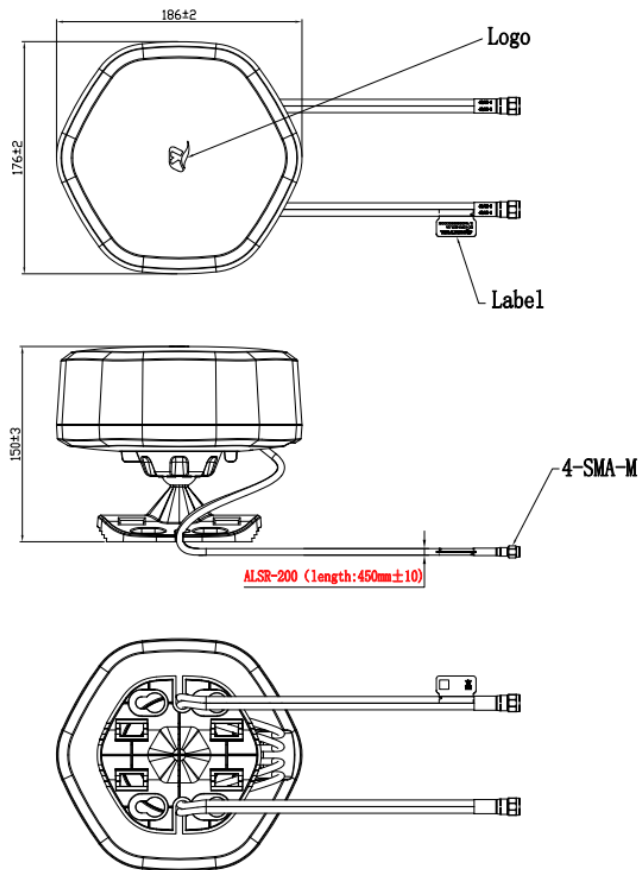

3 Detailed Performance

3.1. S-Parameter Test

3.1.1. VSWR

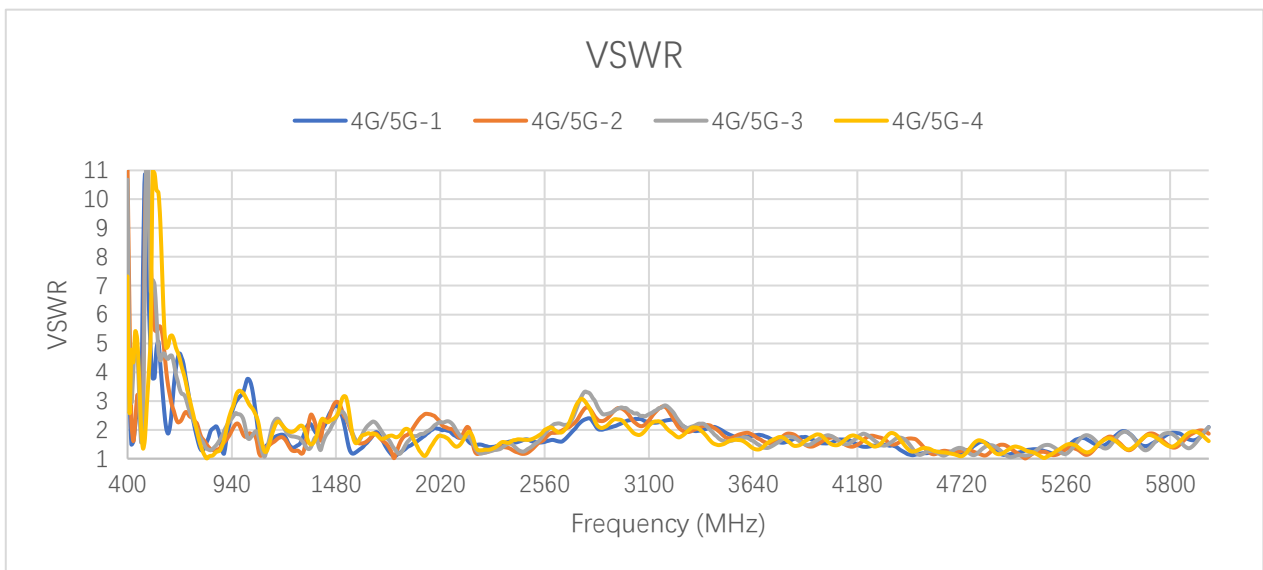

VSWR

Frequency (MHz)	600	630	710	830	900	960	1440	1710	1740	1880
4G/5G-1	2.1	2.7	3.5	2.0	1.2	3.0	2.5	1.8	1.4	1.5
4G/5G-2	4.1	2.8	2.6	1.3	1.6	2.2	2.4	1.7	1.5	2.1
4G/5G-3	4.5	4.6	2.9	1.3	2.0	2.6	1.9	2.0	1.7	1.8
4G/5G-4	4.8	5.3	3.4	1.1	1.7	3.2	2.3	1.7	1.7	1.7
Frequency (MHz)	1950	2140	2350	2450	2600	3600	4700	5000	5500	6000
4G/5G-1	1.9	1.8	1.5	1.6	1.7	1.7	1.2	1.2	1.7	2.1
4G/5G-2	2.6	1.9	1.4	1.2	1.9	1.9	1.2	1.2	1.7	1.9
4G/5G-3	1.9	1.7	1.4	1.2	2.1	1.7	1.4	1.1	1.5	2.1
4G/5G-4	1.2	1.7	1.6	1.7	2.1	1.6	1.1	1.4	1.7	1.6

3.1.2. Return Loss



Return Loss (dB)

Frequency (MHz)	600	630	710	830	900	960	1440	1710	1740	1880
4G/5G-1	-9.2	-6.7	-5.1	-9.8	-21.9	-6.1	-7.5	-11.3	-15.8	-13.6
4G/5G-2	-4.4	-6.4	-7.1	-16.9	-13.1	-8.6	-7.8	-11.7	-13.7	-9.1
4G/5G-3	-3.9	-3.9	-6.3	-17.9	-9.8	-7.1	-10.0	-9.5	-11.5	-11.1
4G/5G-4	-3.6	-3.3	-5.3	-26.6	-12.1	-5.7	-8.2	-11.7	-11.4	-11.9
Frequency (MHz)	1950	2140	2350	2450	2600	3600	4700	5000	5500	6000
4G/5G-1	-10.4	-10.8	-13.6	-12.2	-12.2	-11.3	-21.5	-21.2	-11.8	-9.0
4G/5G-2	-7.2	-10.2	-15.5	-22.3	-10.2	-10.2	-19.5	-19.9	-11.3	-10.4
4G/5G-3	-9.9	-11.5	-15.0	-19.3	-8.8	-11.5	-16.2	-26.8	-13.5	-9.1
4G/5G-4	-22.7	-12.1	-13.0	-12.1	-9.2	-13.2	-25.4	-15.2	-11.9	-12.6

3.1.3. Isolation

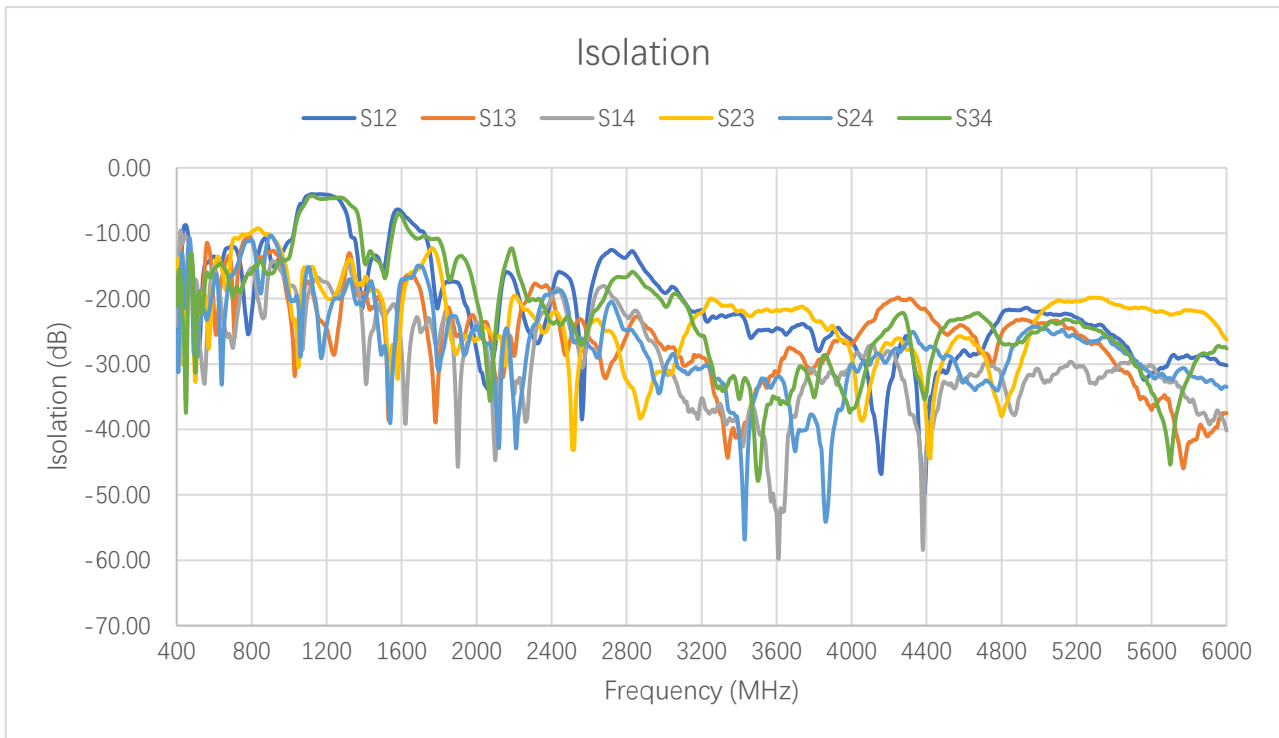

Max Isolation (dB)

Band	B31/ B88	B71	B12/ B13/ B28	B5/ B8/ B26	N74/ N75/ N76	B1/ B2/ B3	B40	Wi-Fi 2G	B38/ B41	B42/ B48/ N77	N79	Wi-Fi 5G
Freq. (MHz)	410- 470	600- 700	700- 810	820- 960	1420- 1520	1700- 2170	2300- 2400	2400- 2500	2500- 2690	3300- 4200	4400- 5000	5150- 5850
S12	-8.8	-12.0	-12.1	-10.8	-13.2	-9.7	-19.5	-15.9	-13.1	-22.3	-21.4	-22.3
S13	-12.0	-13.4	-10.4	-12.7	-19.7	-20.1	-17.7	-19.4	-23.1	-20.4	-21.9	-24.5
S14	-9.6	-14.9	-15.3	-14.3	-21.0	-22.1	-19.9	-18.4	-18.1	-27.2	-29.9	-29.4
S23	-13.1	-11.1	-9.6	-9.2	-17.5	-12.3	-22.2	-22.0	-23.2	-20.9	-22.5	-19.8
S24	-10.7	-16.2	-11.0	-10.4	-17.4	-15.1	-19.1	-18.7	-22.1	-28.4	-24.2	-25.5
S34	-13.7	-14.6	-15.4	-14.0	-12.8	-10.4	-20.0	-22.9	-19.2	-24.4	-22.2	-23.2

3.2. Radiation Performance Test

3.2.1. Efficiency

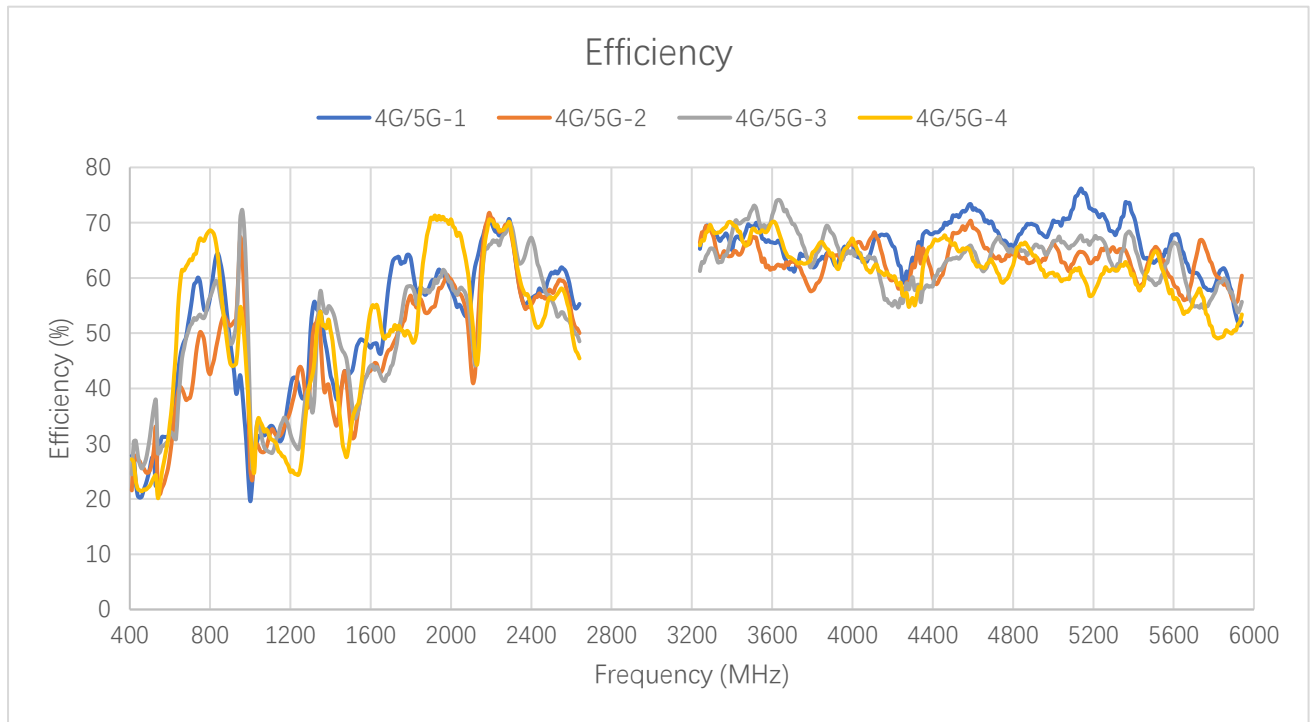

Efficiency (%)

Frequency (MHz)	600	630	710	830	900	960	1440	1710	1740	1880
4G/5G-1	30.4	31.2	45.5	54.3	64.4	48.4	44.8	46.3	55.6	59.0
4G/5G-2	21.3	22.7	40.3	48.8	49.1	51.3	40.7	42.9	46.2	55.2
4G/5G-3	28.2	29.7	41.3	52.8	58.8	48.1	54.9	42.3	42.4	57.1
4G/5G-4	20.2	26.7	58.8	66.7	63.5	44.6	52.5	51.4	49.6	48.7
Frequency (MHz)	1950	2140	2350	2450	2600	3600	4700	5000	5500	6000
4G/5G-1	58.2	53.0	70.7	55.8	61.3	68.6	71.9	68.1	64.8	52.0
4G/5G-2	53.9	52.9	69.6	54.7	59.7	64.5	67.1	62.9	58.8	60.4
4G/5G-3	57.4	56.2	70.1	66.7	53.3	69.5	61.8	65.7	61.4	55.7
4G/5G-4	69.0	61.9	70.2	56.1	57.6	68.2	62.1	61.5	58.4	53.4

3.2.2. Average Gain

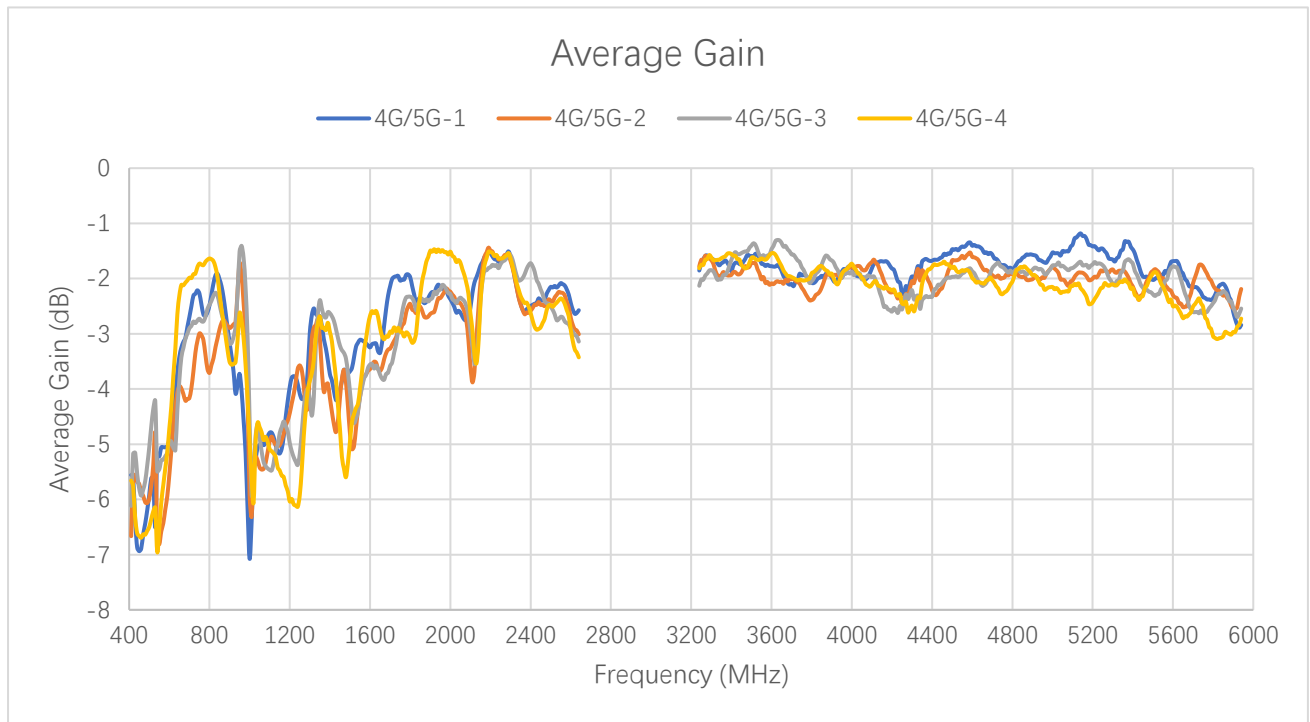

Average Gain (dB)

Frequency (MHz)	600	630	710	830	900	960	1440	1710	1740	1880
4G/5G-1	-5.2	-5.1	-3.4	-2.7	-1.9	-3.1	-3.5	-3.3	-2.6	-2.3
4G/5G-2	-6.7	-6.4	-3.9	-3.1	-3.1	-2.9	-3.9	-3.7	-3.4	-2.6
4G/5G-3	-5.5	-5.3	-3.8	-2.8	-2.3	-3.2	-2.6	-3.7	-3.7	-2.4
4G/5G-4	-7.0	-5.7	-2.3	-1.8	-2.0	-3.5	-2.8	-2.9	-3.0	-3.1
Frequency (MHz)	1950	2140	2350	2450	2600	3600	4700	5000	5500	6000
4G/5G-1	-2.4	-2.8	-1.5	-2.5	-2.1	-1.6	-1.4	-1.7	-1.9	-2.8
4G/5G-2	-2.7	-2.8	-1.6	-2.6	-2.2	-1.9	-1.7	-2.0	-2.3	-2.2
4G/5G-3	-2.4	-2.5	-1.5	-1.8	-2.7	-1.6	-2.1	-1.8	-2.1	-2.5
4G/5G-4	-1.6	-2.1	-1.5	-2.5	-2.4	-1.7	-2.1	-2.1	-2.3	-2.7

3.2.3. Peak Gain

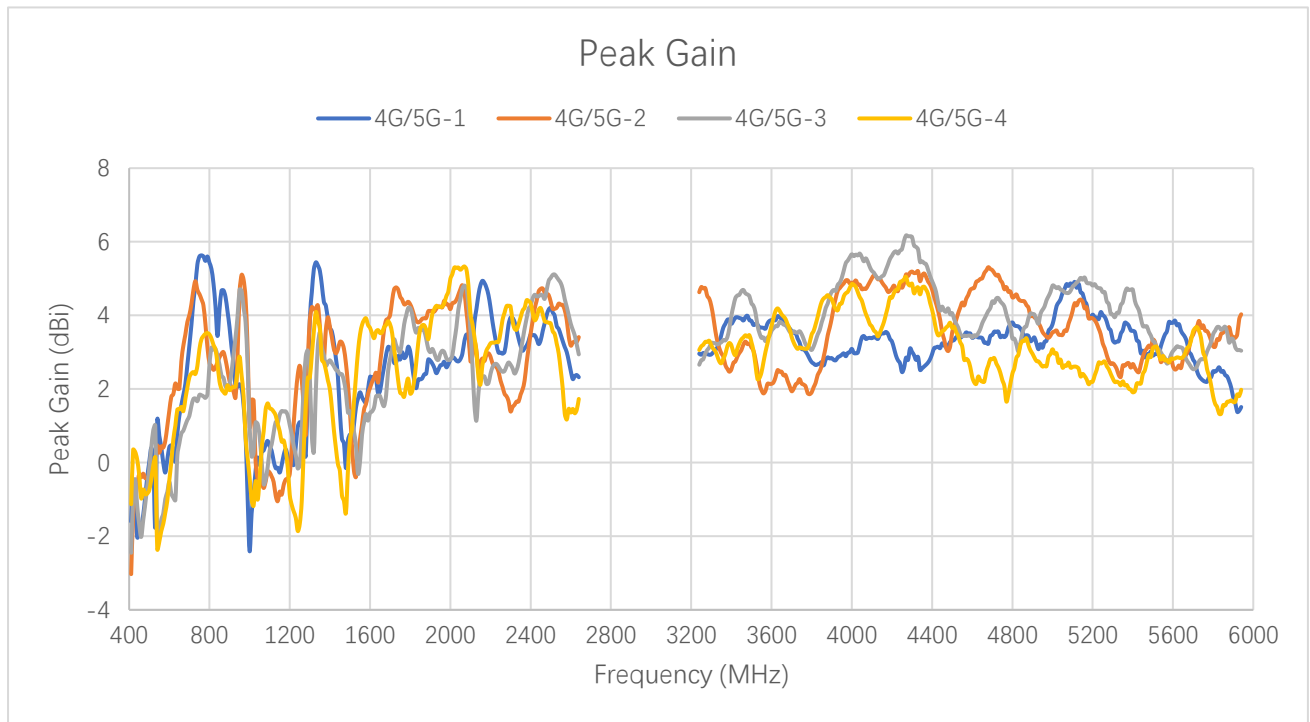

Peak Gain (dBi)

Frequency (MHz)	600	630	710	830	900	960	1440	1710	1740	1880
4G/5G-1	1.2	0.0	1.3	5.6	3.4	3.7	3.9	2.0	2.9	2.2
4G/5G-2	0.5	0.4	2.0	4.3	2.7	2.2	4.0	2.7	3.9	4.0
4G/5G-3	-2.0	-1.4	0.5	1.8	2.9	2.1	2.7	1.8	1.8	3.7
4G/5G-4	-2.4	-1.7	1.5	3.4	2.7	2.0	2.2	3.5	3.7	2.2
Frequency (MHz)	1950	2140	2350	2450	2600	3600	4700	5000	5500	6000
4G/5G-1	2.8	3.5	3.8	3.3	3.6	3.7	3.4	3.2	3.0	1.5
4G/5G-2	4.1	4.1	1.7	3.1	4.3	2.1	5.0	3.7	2.7	4.0
4G/5G-3	3.1	4.8	2.7	4.2	5.0	3.5	3.6	4.0	3.9	3.0
4G/5G-4	3.4	5.3	4.3	4.4	3.0	2.3	2.2	2.7	2.2	2.0

3.2.4. 3D & 2D Radiation Pattern

- Test Status: Free space
- Test Chamber: FS-G-1

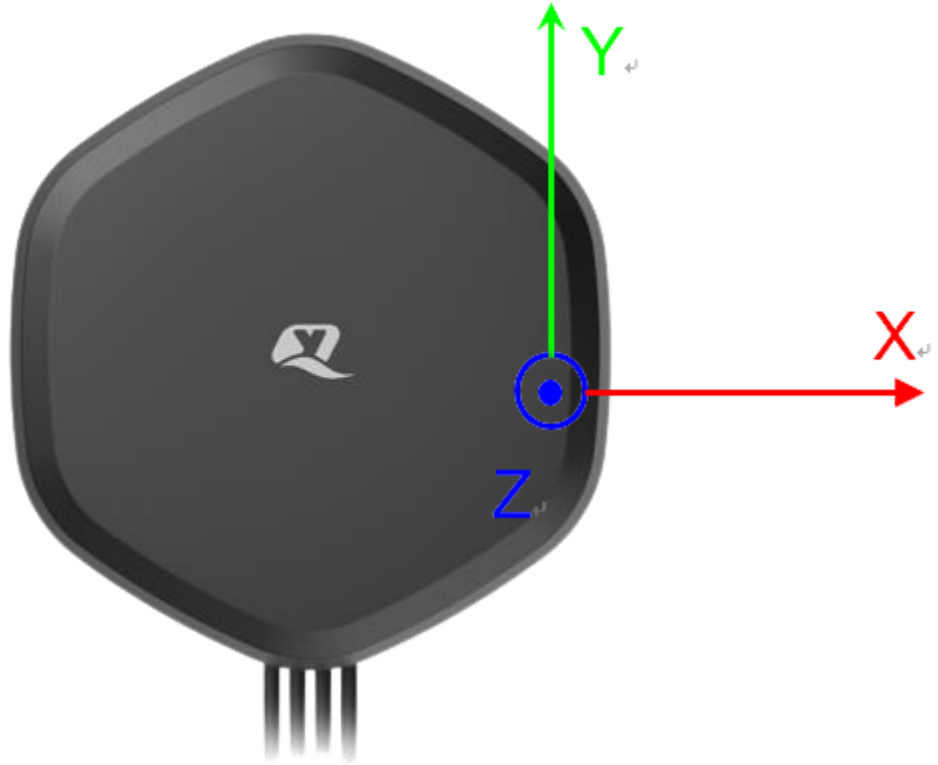

● **4G/5G-1**

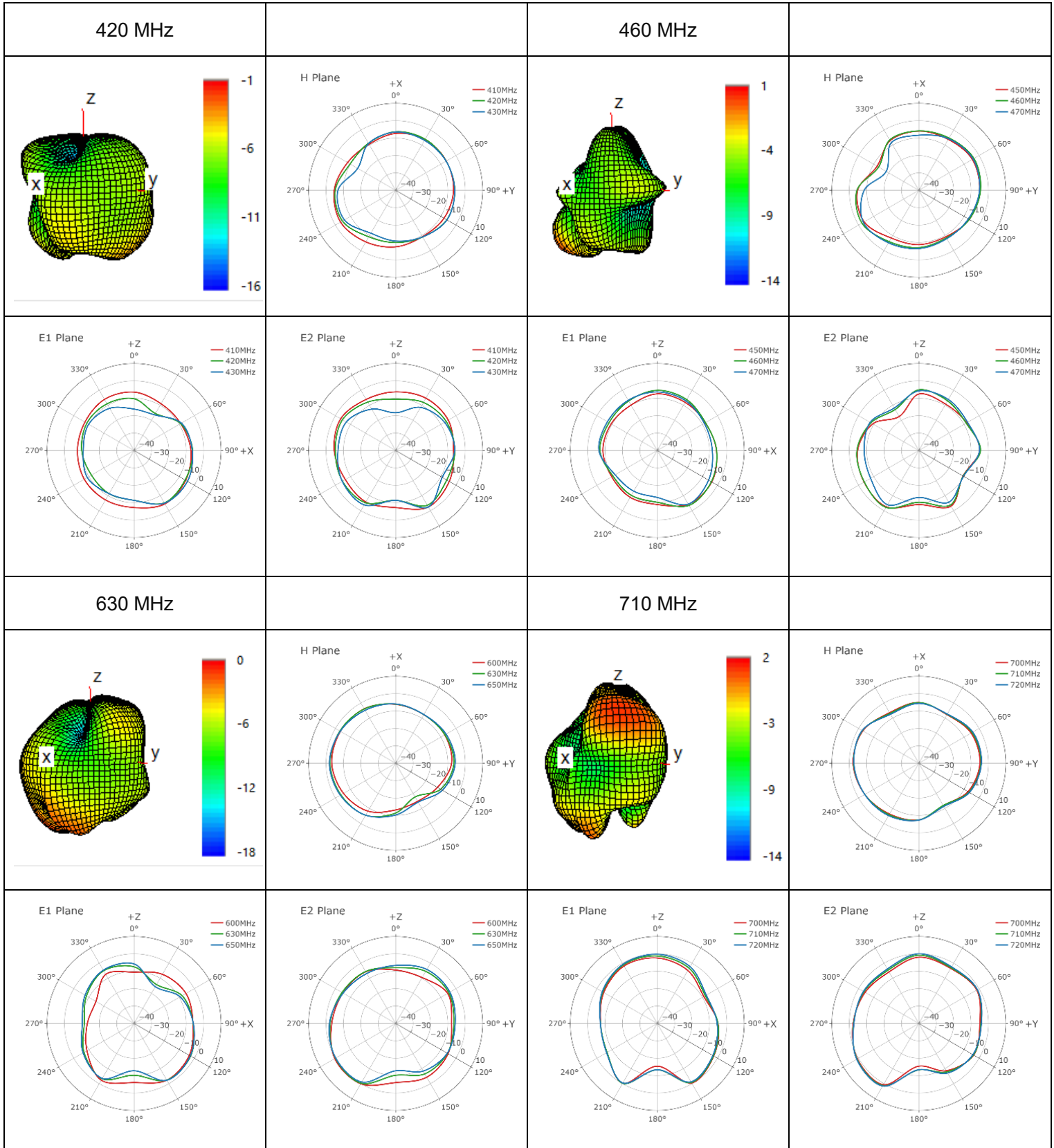

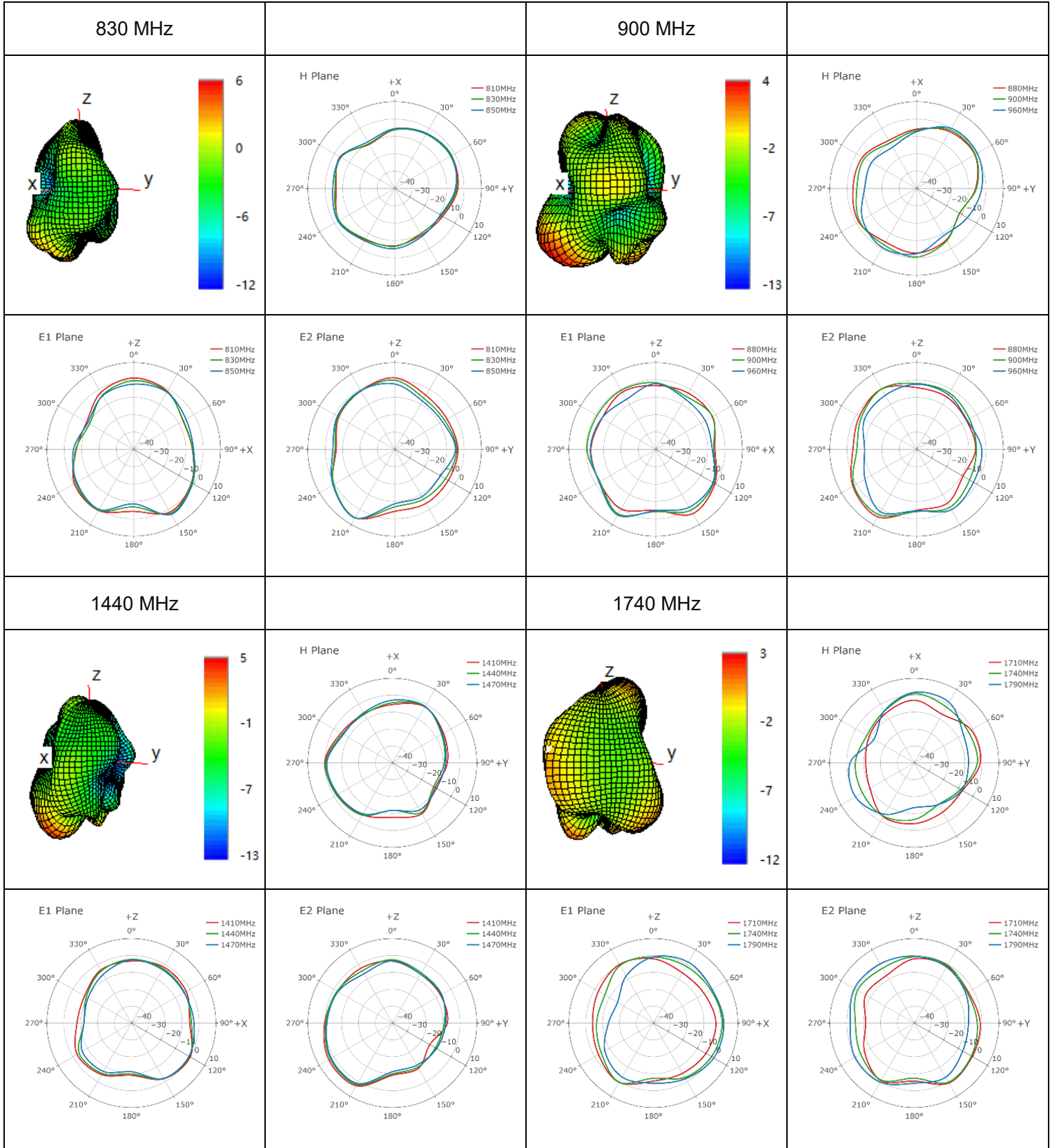

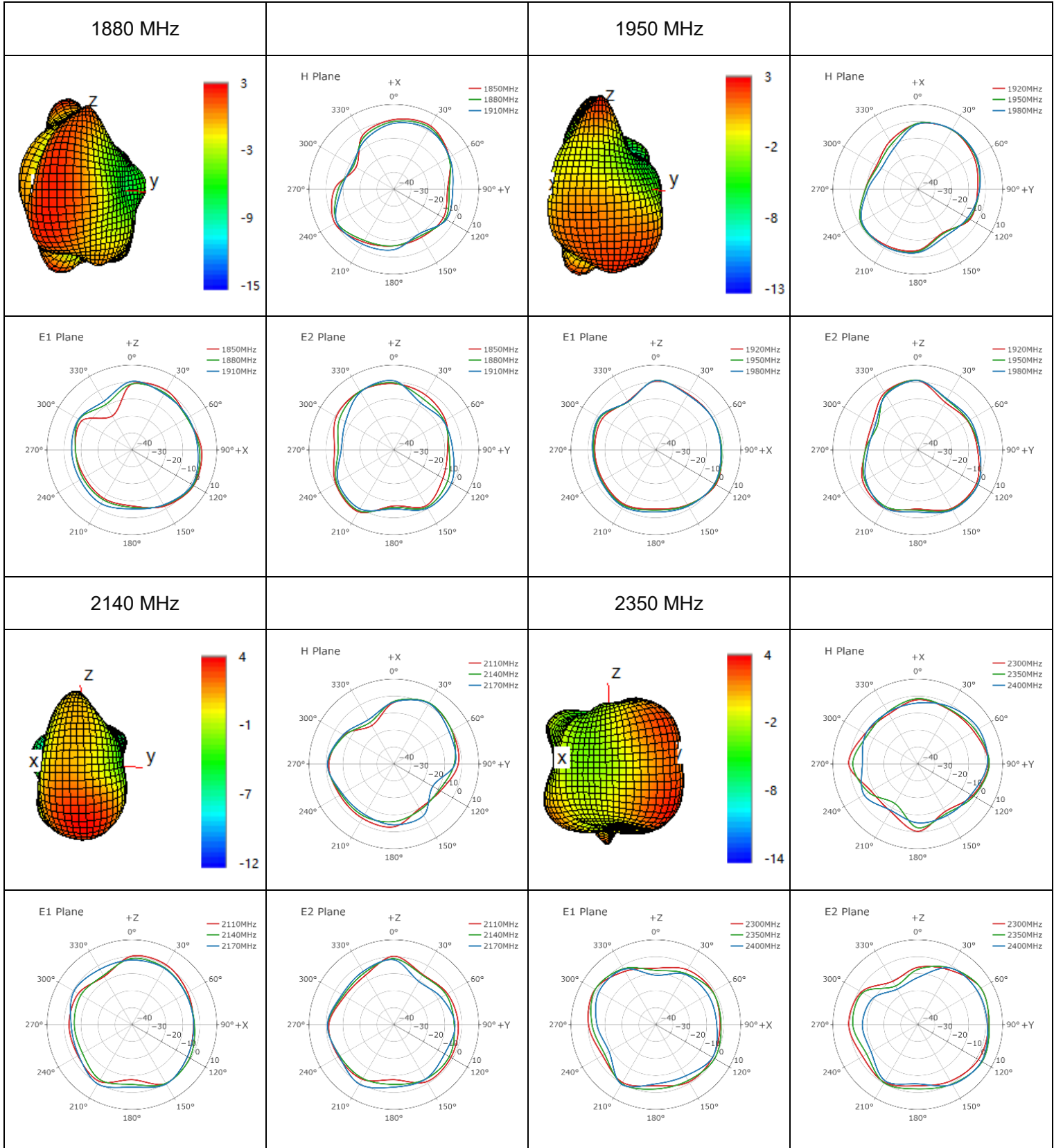

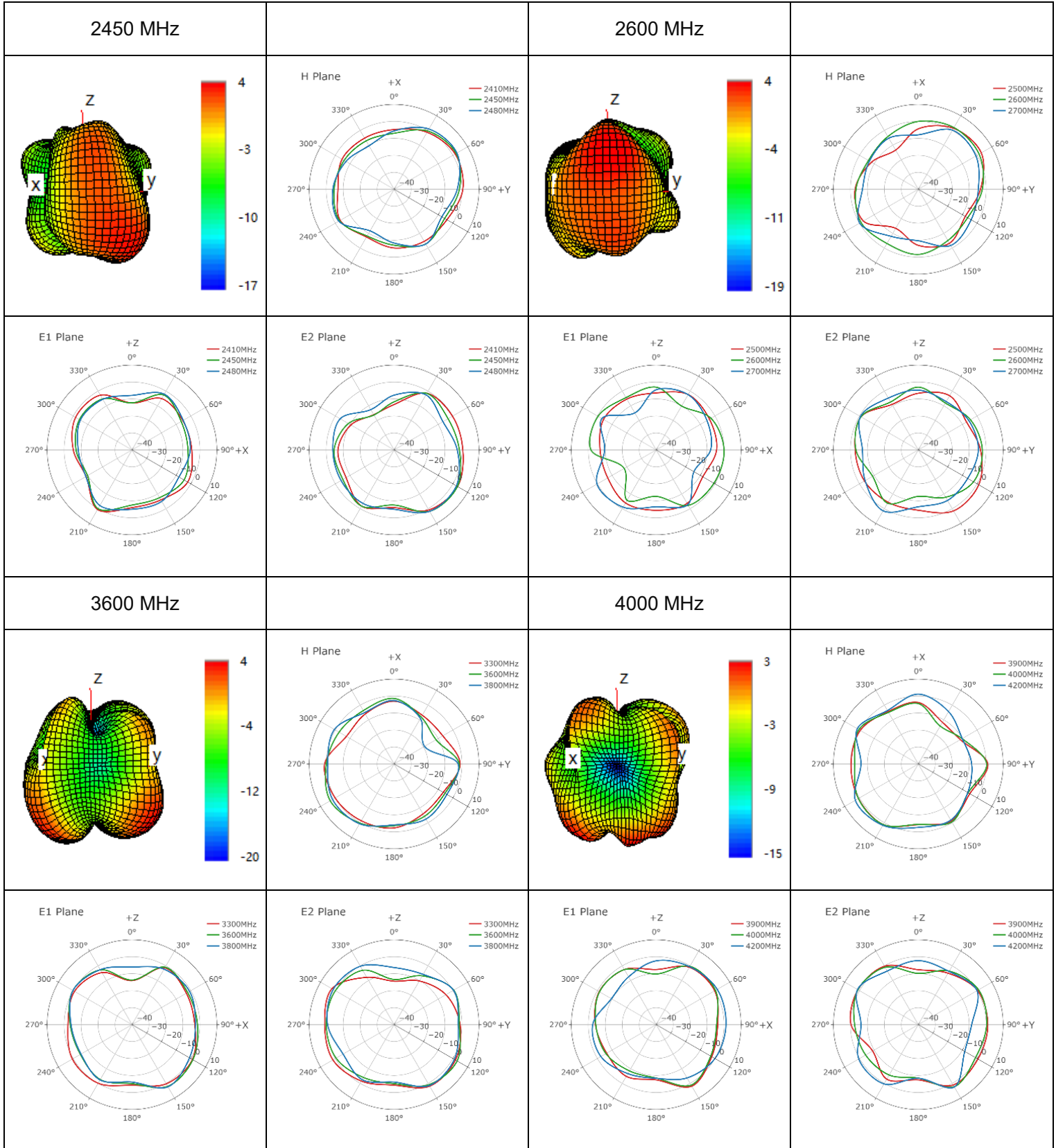

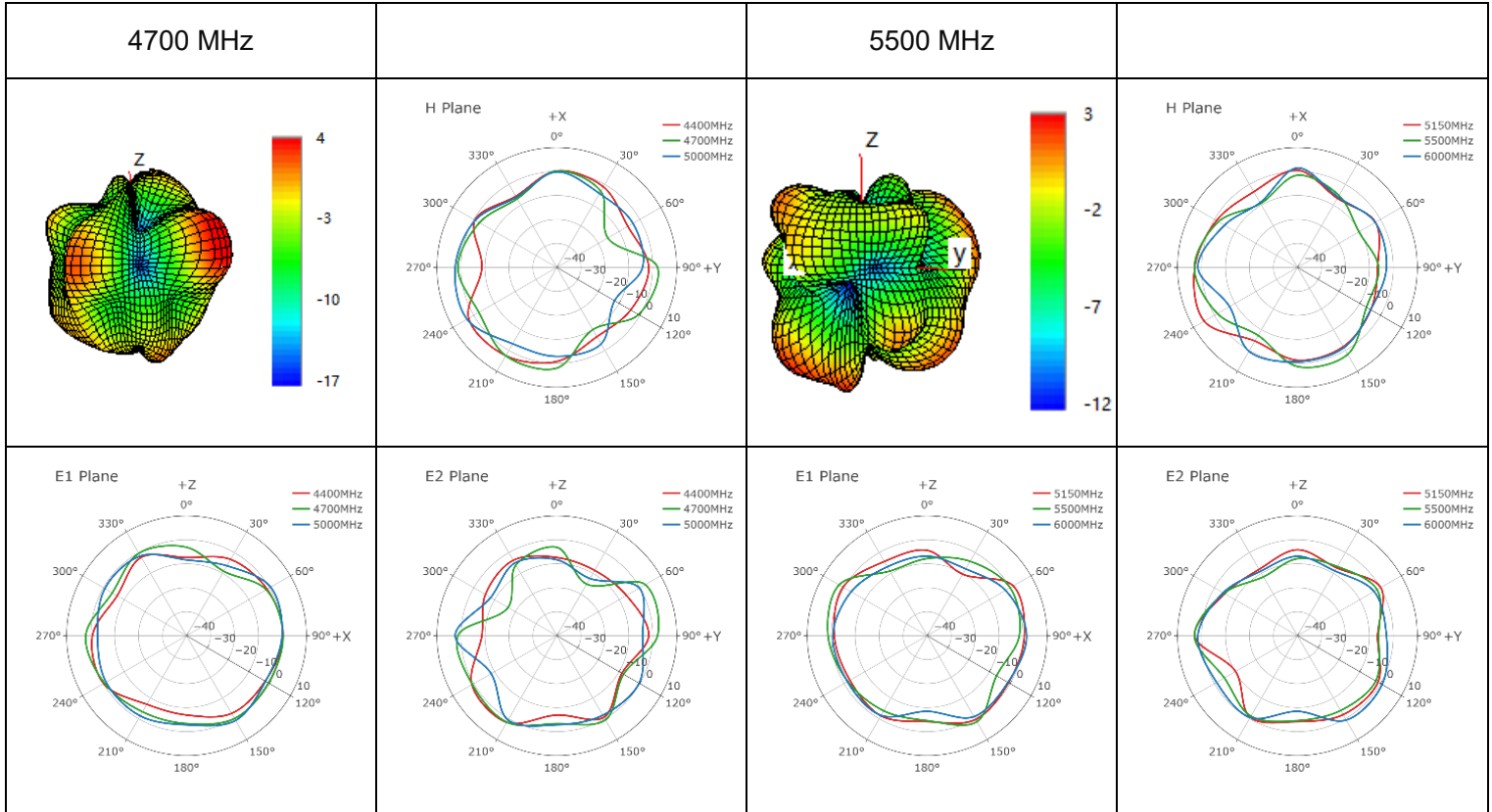

● **4G/5G-2**

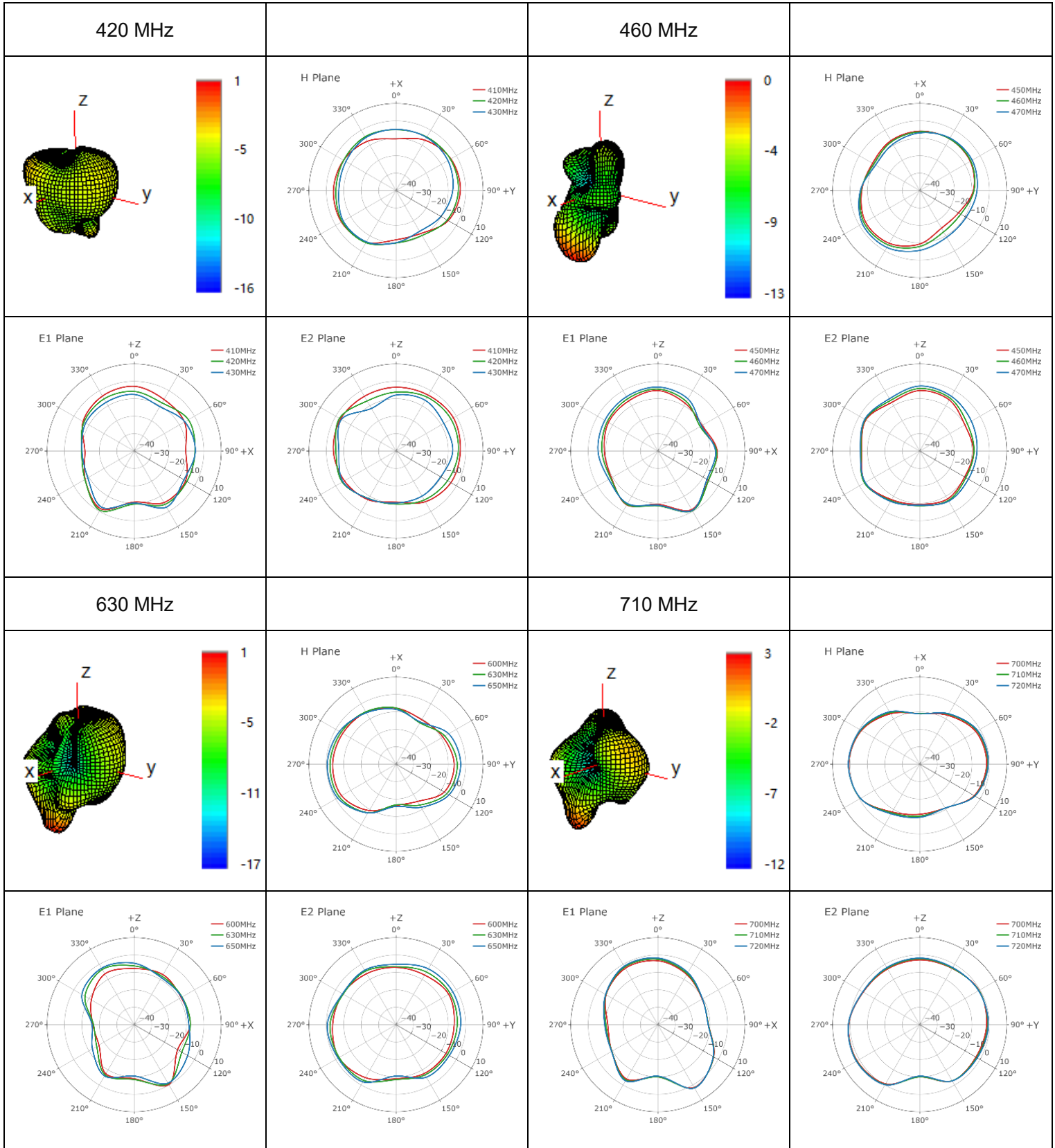

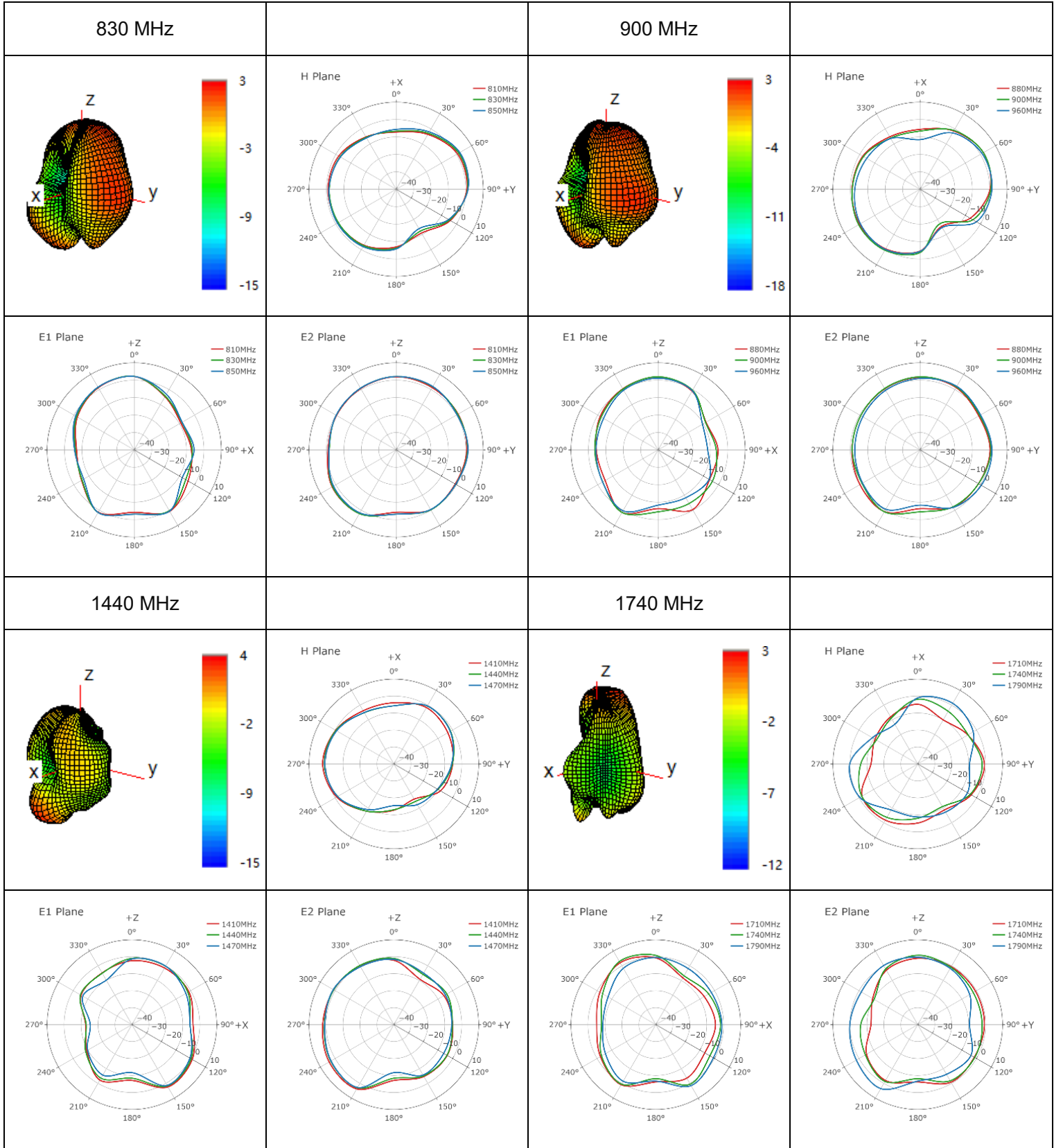

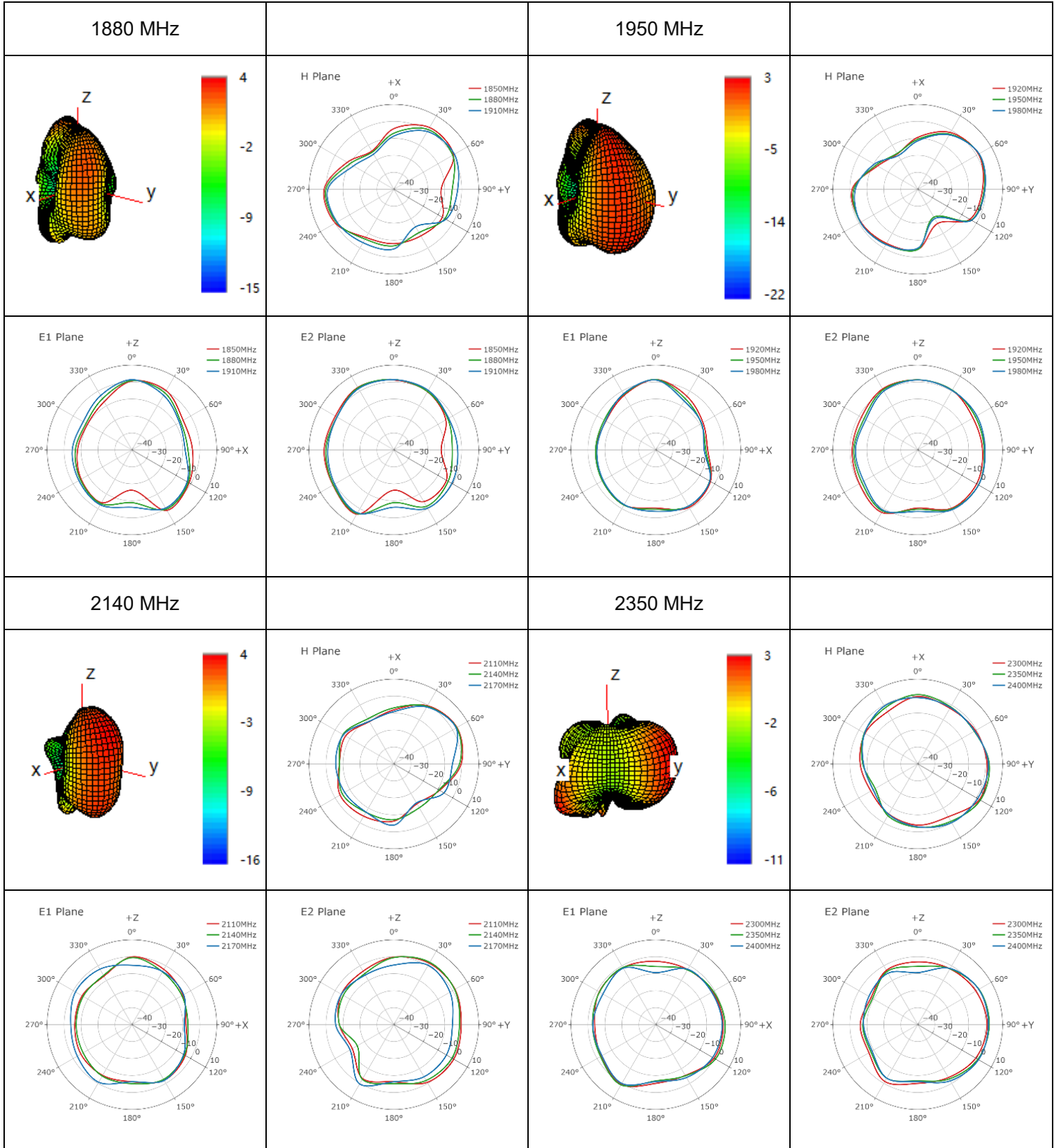

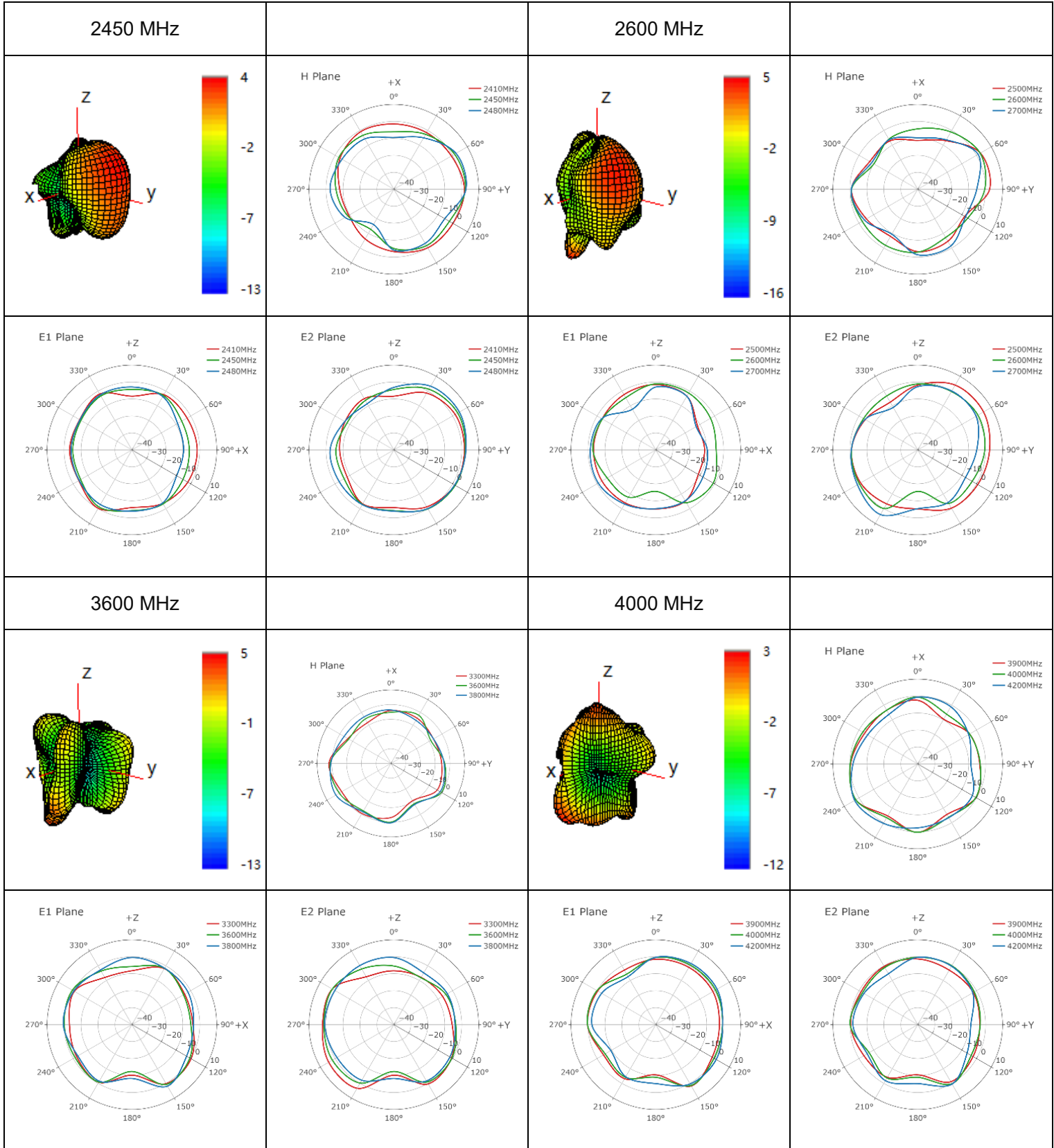

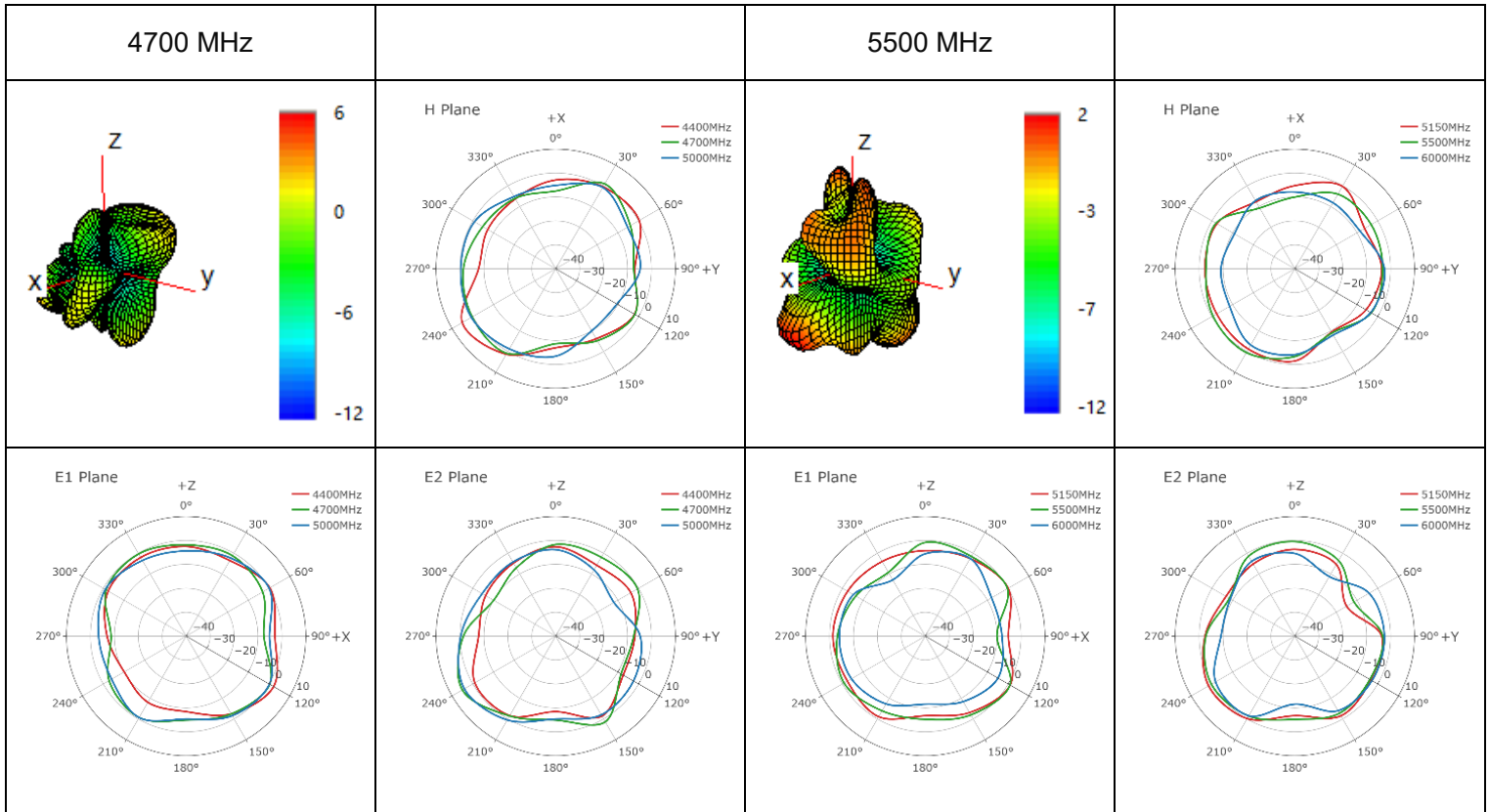

● **4G/5G-3**

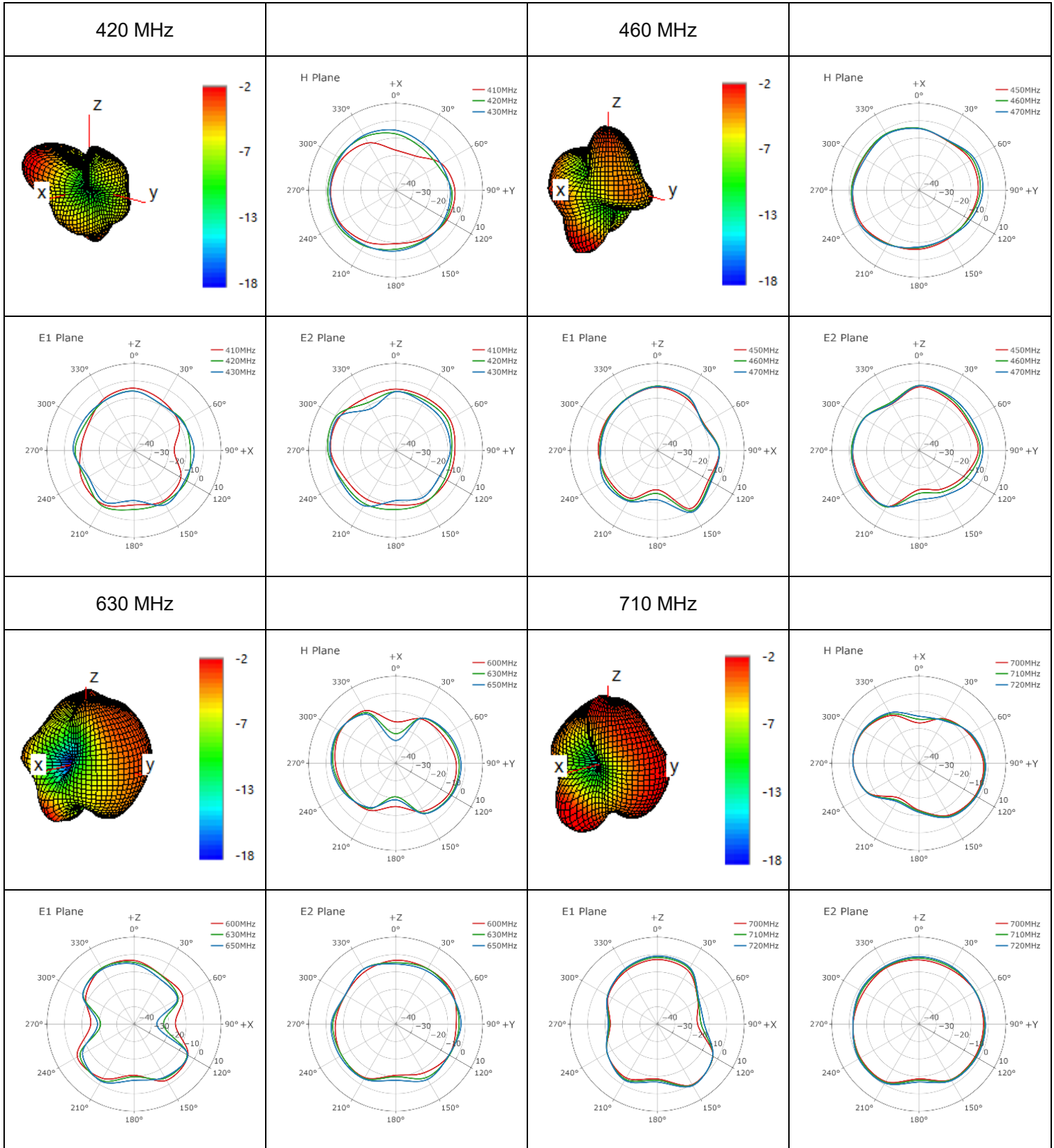

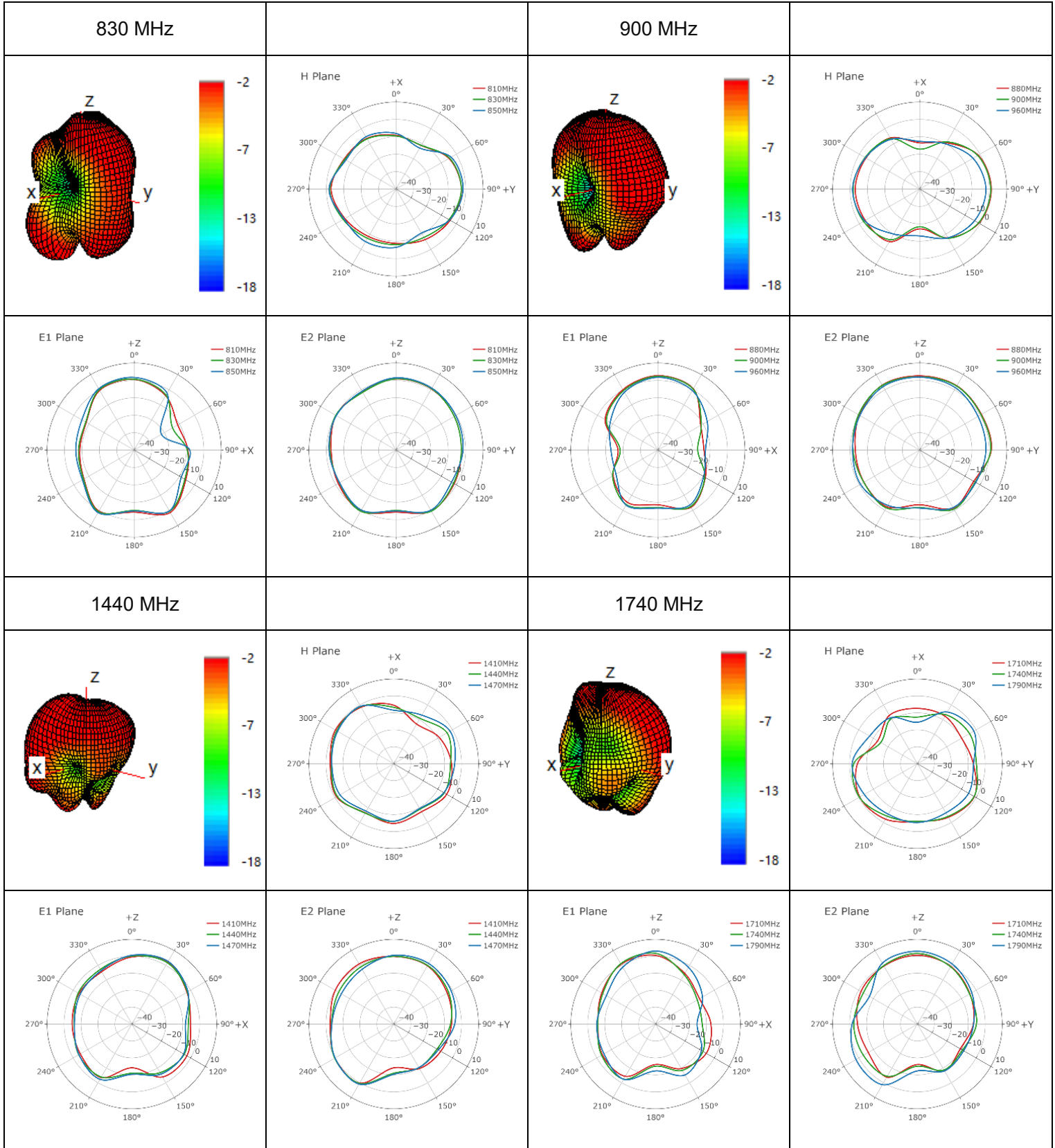

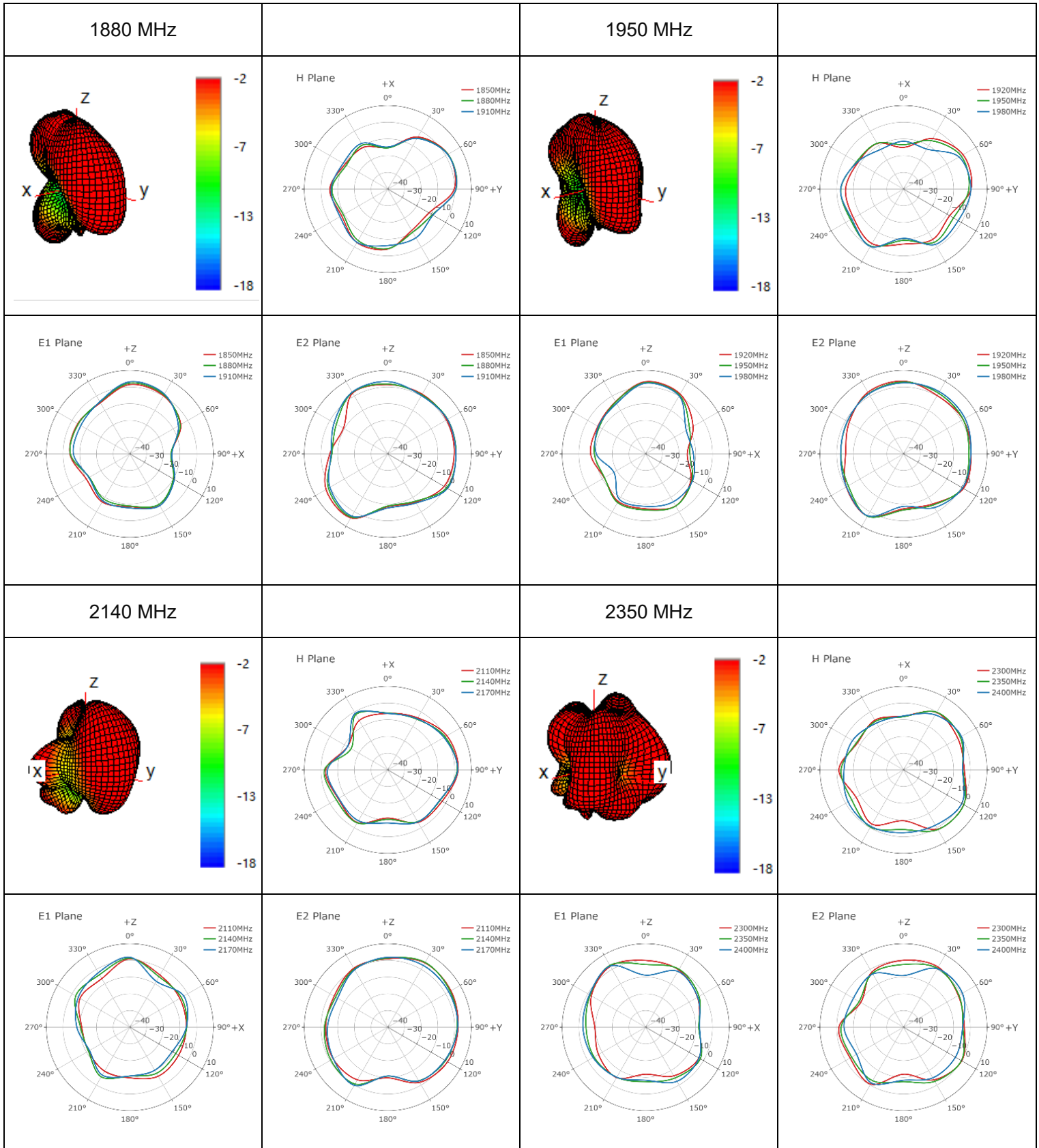

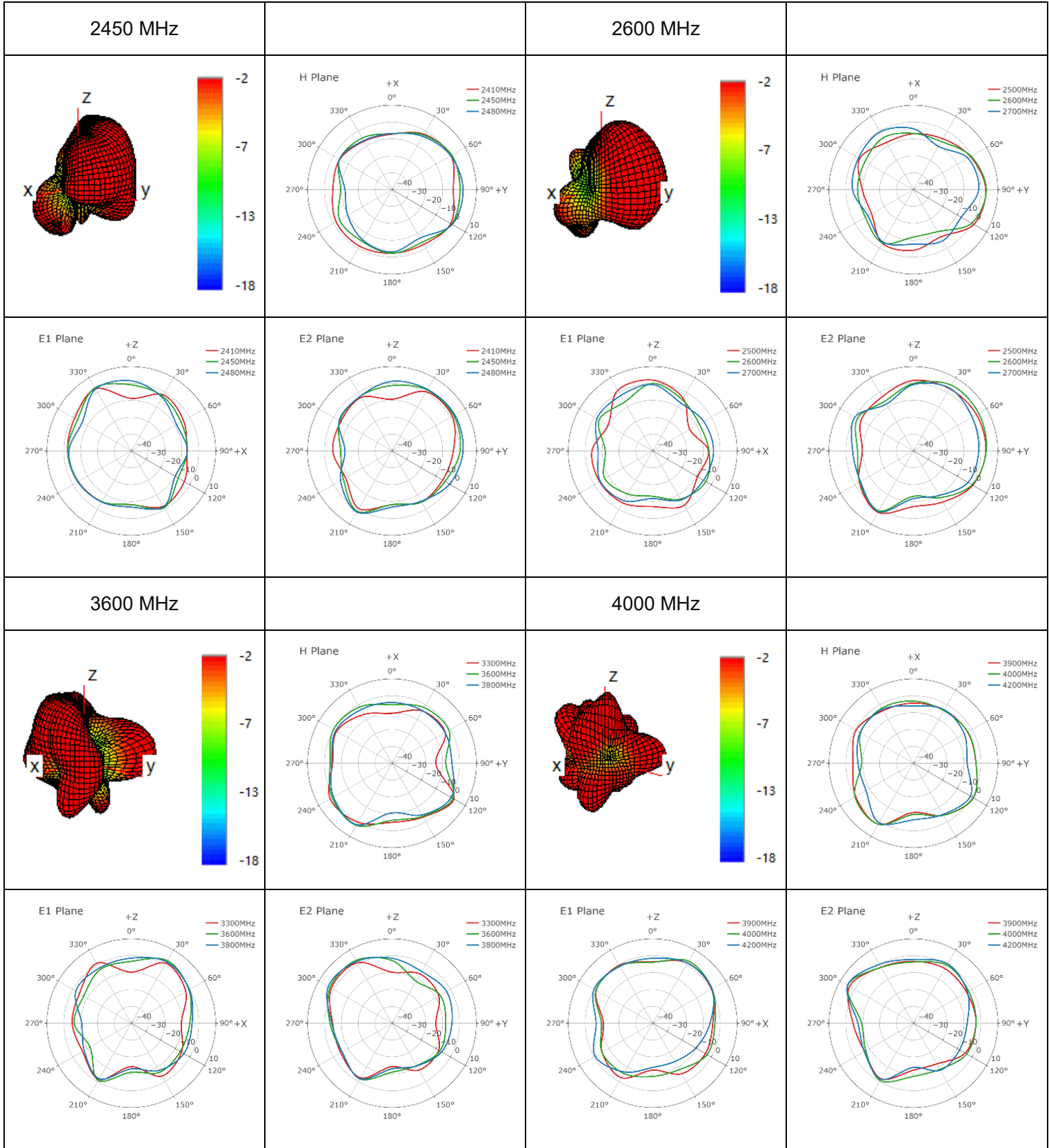

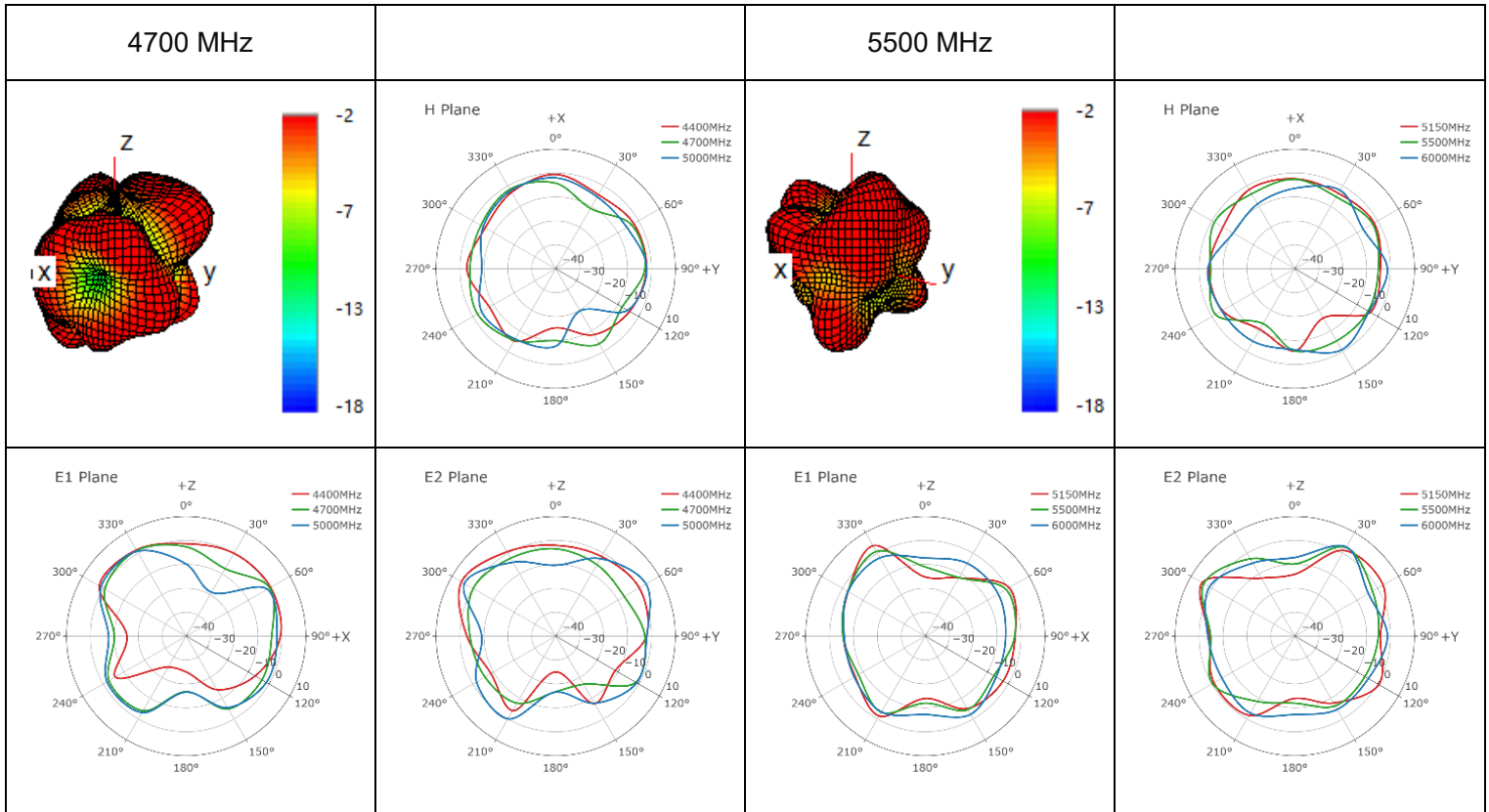

● **4G/5G-4**

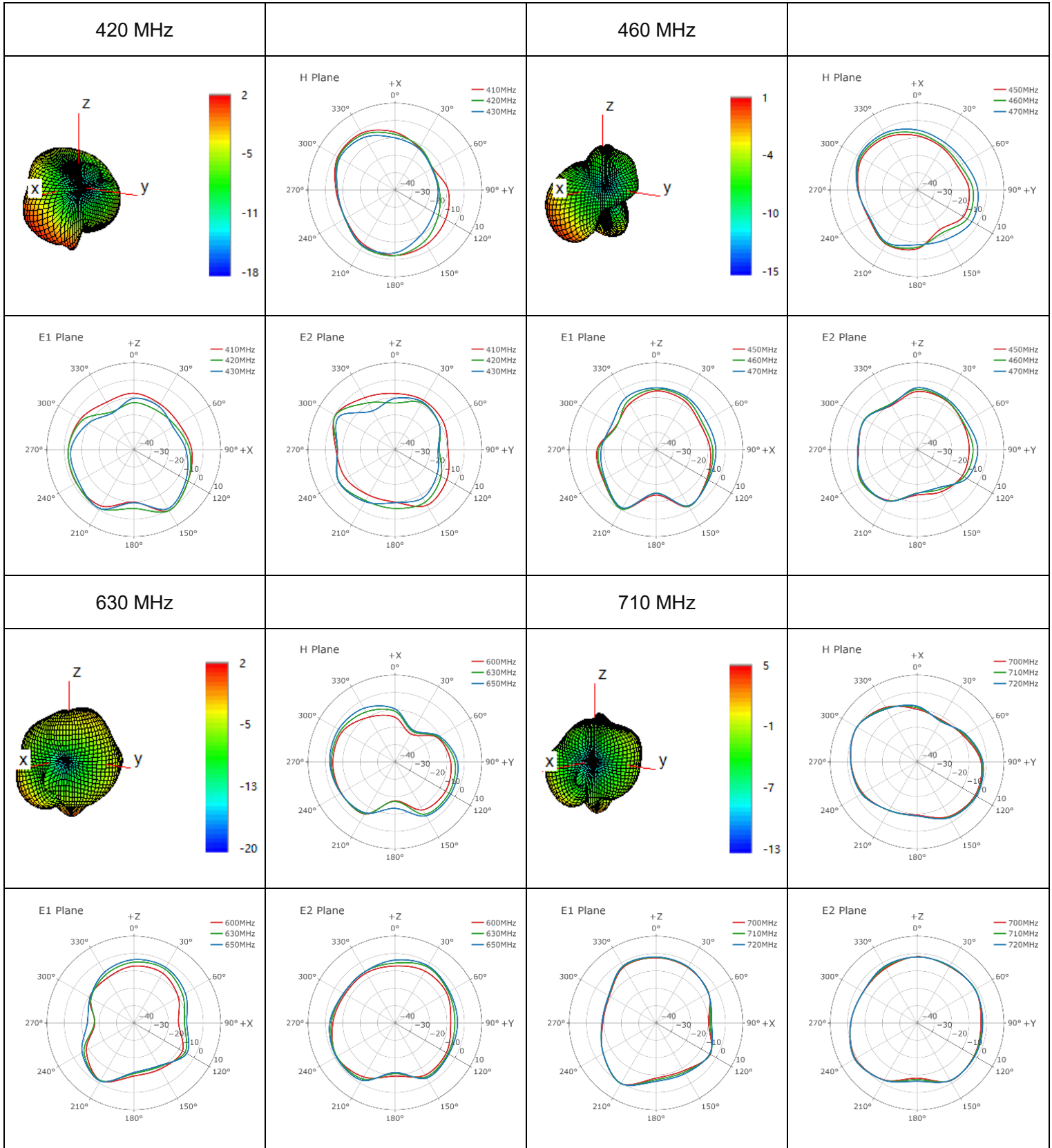

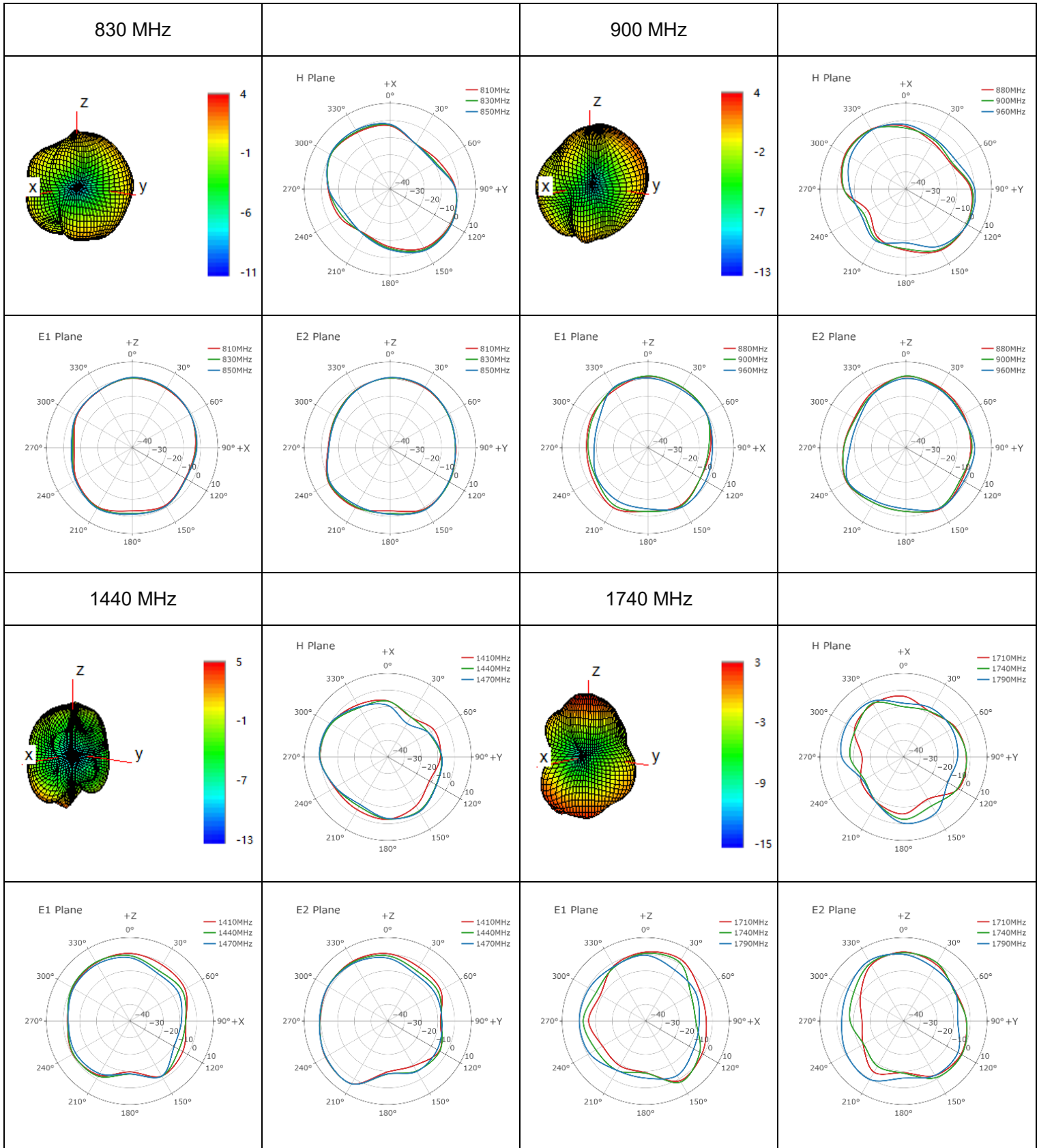

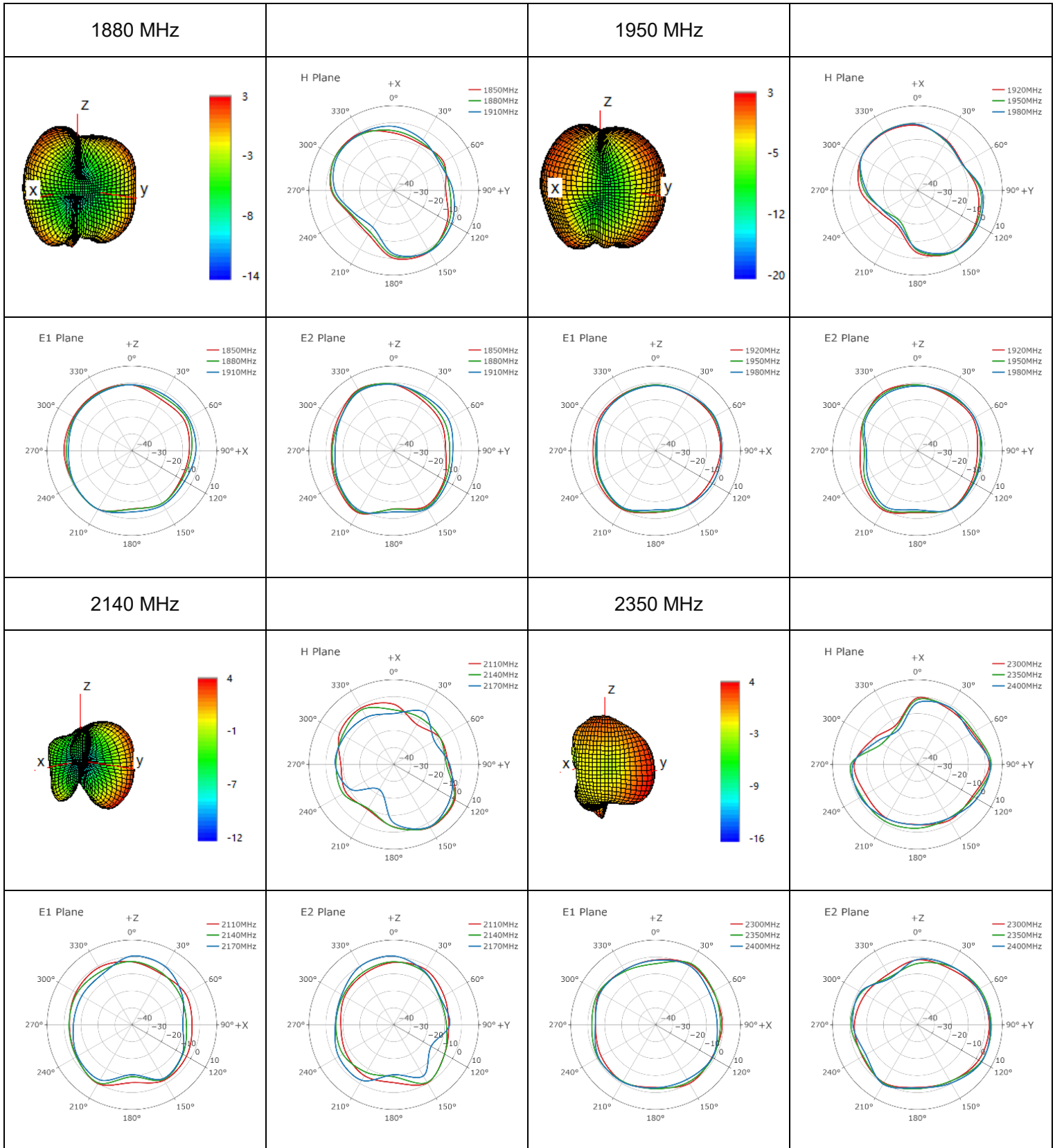

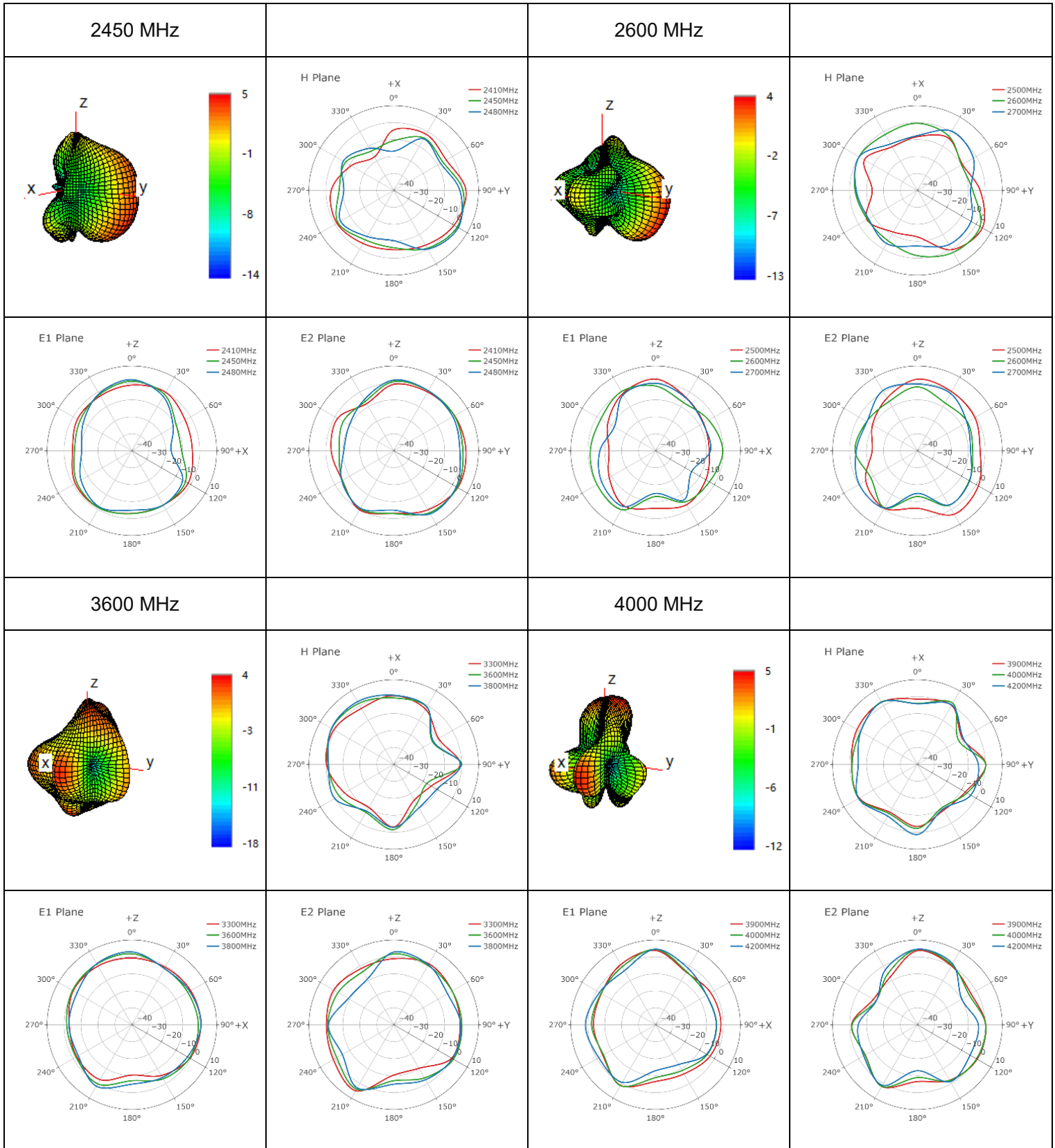

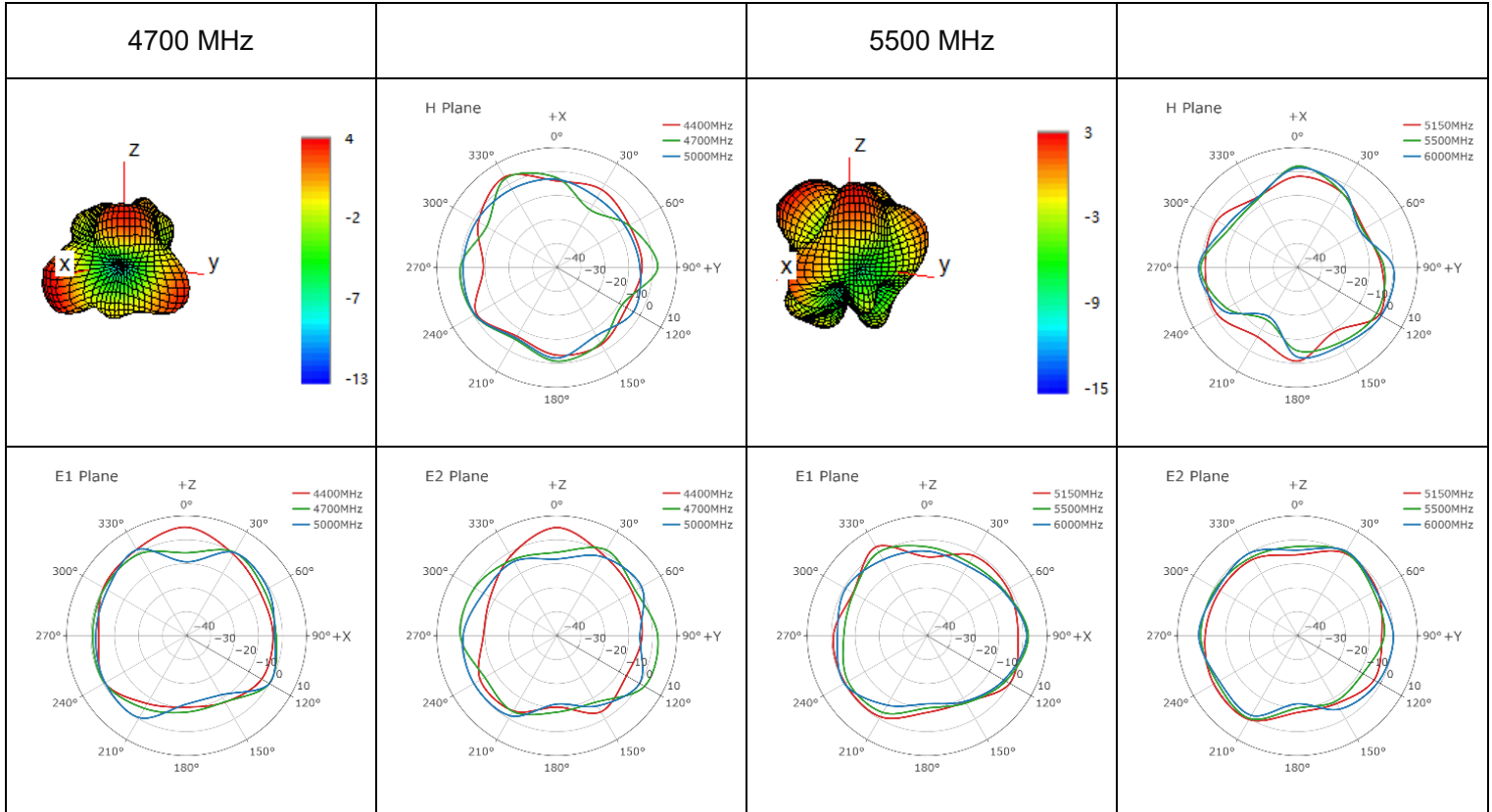

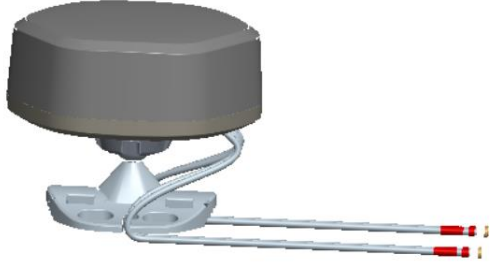

4 Packaging

Step	Packaging Picture / 2D Picture	Description
1		Product drawing
2		1 pc antenna product in an inner box; (1 pc antenna per inner box)
3		4 inner boxes per carton box (4 pcs antennas per carton box) <u>Carton Inside Dimension:</u> <u>L × W × H = 460 × 440 × 225 mm</u>

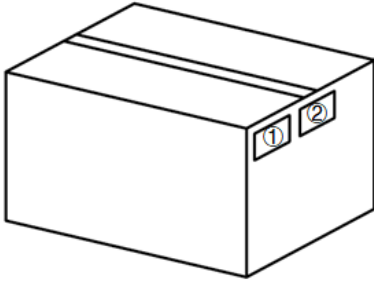
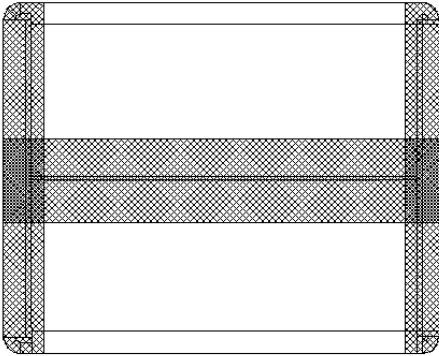
4		<p>Position for Attaching Labels</p> <ul style="list-style-type: none">① Carton Label② Quality Label
5		<p>Sealing Cartons</p> <p>“工” type sealing cartons</p>

Contact Us

At Quectel, our aim is to provide timely and comprehensive services to our customers. If you require any assistance, please contact our headquarters:

Quectel Wireless Solutions Co., Ltd.

Building 5, Shanghai Business Park Phase III (Area B), No.1016 Tianlin Road, Minhang District, Shanghai 200233, China

Tel: +86 21 5108 6236

Email: info@quectel.com

Or our local offices. For more information, please visit:

<http://www.quectel.com/support/sales.htm>.

For technical support, or to report documentation errors, please visit:

<http://www.quectel.com/support/technical.htm>.

Or email us at: support@quectel.com.

Legal Notices

We offer information as a service to you. The provided information is based on your requirements and we make every effort to ensure its quality. You agree that you are responsible for using independent analysis and evaluation in designing intended products, and we provide reference designs for illustrative purposes only. Before using any hardware, software or service guided by this document, please read this notice carefully. Even though we employ commercially reasonable efforts to provide the best possible experience, you hereby acknowledge and agree that this document and related services hereunder are provided to you on an “as available” basis. We may revise or restate this document from time to time at our sole discretion without any prior notice to you.

Use and Disclosure Restrictions

License Agreements

Documents and information provided by us shall be kept confidential, unless specific permission is granted. They shall not be accessed or used for any purpose except as expressly provided herein.

Copyright

Our and third-party products hereunder may contain copyrighted material. Such copyrighted material shall not be copied, reproduced, distributed, merged, published, translated, or modified without prior written consent. We and the third party have exclusive rights over copyrighted material. No license shall be granted or conveyed under any patents, copyrights, trademarks, or service mark rights. To avoid ambiguities, purchasing in any form cannot be deemed as granting a license other than the normal non-exclusive, royalty-free license to use the material. We reserve the right to take legal action for noncompliance with abovementioned requirements, unauthorized use, or other illegal or malicious use of the material.

Trademarks

Except as otherwise set forth herein, nothing in this document shall be construed as conferring any rights to use any trademark, trade name or name, abbreviation, or counterfeit product thereof owned by Quectel or any third party in advertising, publicity, or other aspects.

Third-Party Rights

This document may refer to hardware, software and/or documentation owned by one or more third parties (“third-party materials”). Use of such third-party materials shall be governed by all restrictions and obligations applicable thereto.

We make no warranty or representation, either express or implied, regarding the third-party materials, including but not limited to any implied or statutory, warranties of merchantability or fitness for a particular purpose, quiet enjoyment, system integration, information accuracy, and non-infringement of any third-party intellectual property rights with regard to the licensed technology or use thereof. Nothing herein constitutes a representation or warranty by us to either develop, enhance, modify, distribute, market, sell, offer for sale, or otherwise maintain production of any our products or any other hardware, software, device, tool, information, or product. We moreover disclaim any and all warranties arising from the course of dealing or usage of trade.

Privacy Policy

To implement module functionality, certain device data are uploaded to Quectel's or third-party's servers, including carriers, chipset suppliers or customer-designated servers. Quectel, strictly abiding by the relevant laws and regulations, shall retain, use, disclose or otherwise process relevant data for the purpose of performing the service only or as permitted by applicable laws. Before data interaction with third parties, please be informed of their privacy and data security policy.

Disclaimer

- a) We acknowledge no liability for any injury or damage arising from the reliance upon the information.
- b) We shall bear no liability resulting from any inaccuracies or omissions, or from the use of the information contained herein.
- c) While we have made every effort to ensure that the functions and features under development are free from errors, it is possible that they could contain errors, inaccuracies, and omissions. Unless otherwise provided by valid agreement, we make no warranties of any kind, either implied or express, and exclude all liability for any loss or damage suffered in connection with the use of features and functions under development, to the maximum extent permitted by law, regardless of whether such loss or damage may have been foreseeable.
- d) We are not responsible for the accessibility, safety, accuracy, availability, legality, or completeness of information, advertising, commercial offers, products, services, and materials on third-party websites and third-party resources.

Copyright © Quectel Wireless Solutions Co., Ltd. 2023. All rights reserved.

Revision History

Version	Date	Author	Note
-	2023-06-19	Mordecai LIU/ Hart HU/ David LIU/ Bunny ZHANG	Creation of the document
1.0	2023-06-19	Mordecai LIU/ Hart HU/ David LIU/ Bunny ZHANG	First official release

QUECTEL

www.quectel.com