



Antenna Datasheet

Product OC: YCGO009AA

Version: 3.0

Date: 2023-09-04

Status: Released

Product Name: Active GPS L1 &GLONASS G1 Antenna

Key Features:

Frequency Band: 1565–1609 MHz

Dimensions: 15 × 15 × 6.2 mm

Efficiency: Up to 36.1 %

GNSS LNA Gain: 17 ±3 dB

RoHS Compliant

Overview

This Quectel GNSS antenna adopts a diversity of forms to guarantee the most suitable polarization type. Quectel's positioning products support single-band or multi-band operation modes to meet various high-precision positioning requirements of customers' products. Quectel also provides both passive and active antennas to satisfy the customer demand for high gain. Such antenna supports different installation or connection methods such as pin mount, surface mount, magnetic mount, internal cable, and external SMA. Customized connector type and cable length are provided according to requirements.

Contents

Overview.....	1
Contents.....	2
1 Specification.....	3
1.1. Electrical.....	3
1.2. Mechanical & Environmental	4
1.3. Block Diagram (Active Antenna).....	5
1.4. Supported GNSS Frequency Bands.....	6
2 Drawing	8
3 Detailed Performance.....	9
3.1. S-Parameter Test	9
3.1.1. VSWR.....	9
3.1.2. Return Loss	10
3.1.3. GNSS LNA Gain.....	11
3.1.4. Noise Figure	12
3.2. Radiation Performance Test.....	13
3.2.1. Efficiency	13
3.2.2. Peak Gain.....	14
3.2.3. 3D & 2D Radiation Pattern.....	15
4 Packaging	17
Contact Us.....	19
Legal Notices	20
Revision History	22

1 Specification

Test Condition: By 15 mm square ground plane

1.1. Electrical

Electrical	
Frequency Range	1565–1606 MHz
Impedance	50 Ω
Polarization	Directional
Radiation Pattern	RHCP

Band	GPS L5	GALILEO	GPS L2	GLONASS	BEIDOU	BEIDOU	GPS L1	
	GALILEO E5a	GALILEO E5b	GPS L2 QZSS L2C	GLONASS G2	BEIDOU B3	BEIDOU B1I	GALILEO E1	GLONASS G1
Frequency (MHz)	BEIDOU B2a-B2I	BEIDOU B2b					BEIDOU B1C	
	QZSS L5						QZSS L1	
	IRNSS L5							
	1176	1207	1227	1248	1268	1561	1575	1602
VSWR	-	-	-	-	-	-	1.7	1.6
Return Loss (dB)	-	-	-	-	-	-	-11.7	-13.0
Efficiency (%)	-	-	-	-	-	-	25.6	36.1
Peak Gain (dBi)	-	-	-	-	-	-	-0.3	0.1

LNA Electrical	
LNA Gain	17 ±3 dB
Noise Figure	Typ.1.5 dB (25 +5 °C)
Output VSWR	< 2.0
Filter Out-of-Band Attenuation	44 dB f0 ±100 MHz f0 (1575 MHz)
Working Voltage	DC 3–3.3 V
Working Current	≤10 mA
Impedance	50 Ω

1.2. Mechanical & Environmental

Mechanical	
Antenna Dimensions	15 × 15 × 6.2 mm
Material	PCB + Ceramic
Cable Type & Color & Length	Φ 1.13 & Black & 95 mm
Connector Type	IPEX MHF 1
Mounting Type	Buckle
Weight	Typ. 5.4 g
Environmental	
Operation Temperature	-40 °C to +85 °C
Storage Temperature	-40 °C to +85 °C
RoHS Compliant	Yes

1.3. Block Diagram (Active Antenna)

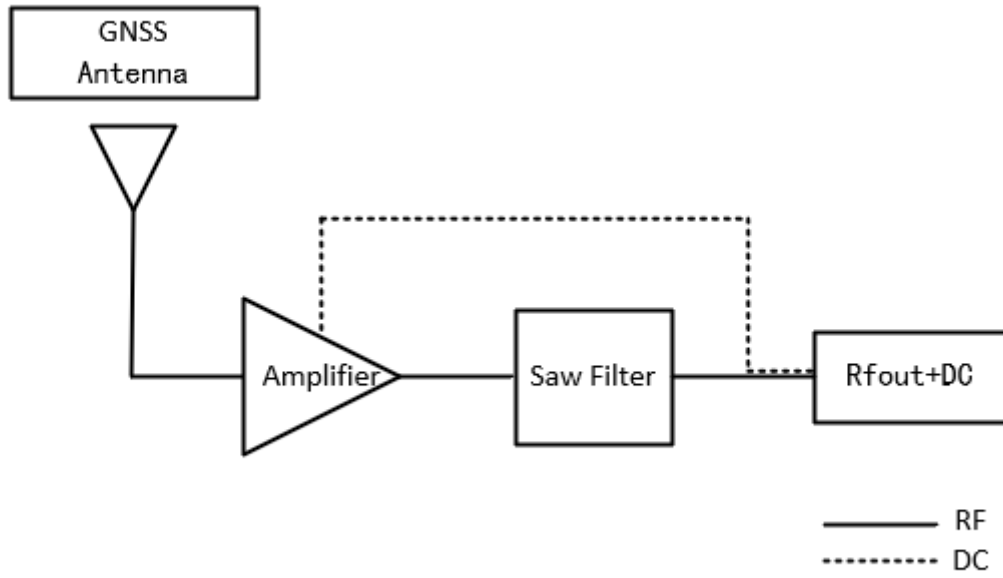

1.4. Supported GNSS Frequency Bands

GNSS Frequency Bands (MHz)					
GPS	L1 Centre 1575.42 (1565–1586)	L2 Centre 1227.6 (1217–1238)	L5 Centre 1176.45 (1164–1189)		
	√	-	-		
GLONASS	G1-L10C-L10F Centre 1601 (1595–1606)	G2-L20C-L20F Centre 1248.06 (1241–1255)	G3-L30C Centre 1202.025 (1189–1213)		
	√	-	-		
GALILEO	E1 Centre 1575.42 (1563–1588)	E5a Centre 1176.45 (1166–1187)	E5b Centre 1207.14 (1197–1218)	E6 Centre 1278.75 (1258–1300)	
	√	-	-	-	
BEIDOU	B1I Centre 1561.098 (1559–1564)	B1C (BeiDou-3) Centre 1575.42 (1559–1592)	B2a Centre 1176.45 (1166–1187)	B2b-B2I Centre 1207.14 (1197–1217)	B3 Centre 1268.52 (1258–1279)
	-	√	-	-	-
QZSS	L1 Centre 1575.42 (1573–1578)	L2C Centre 1227.6 (1226–1229)	L5 Centre 1176.45 (1166–1187)	L6 Centre 1278.75 (1257–1300)	
	√	-	-	-	
IRNSS	L5 Centre 1176.45 (1164–1189)				
	-				

GNSS Bands and Constellations

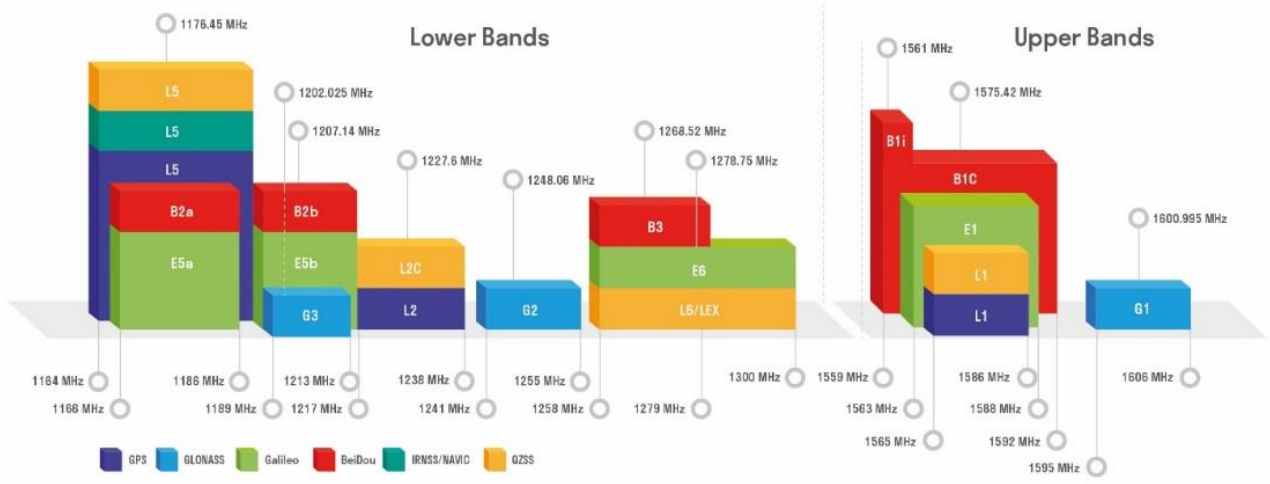

2 Drawing

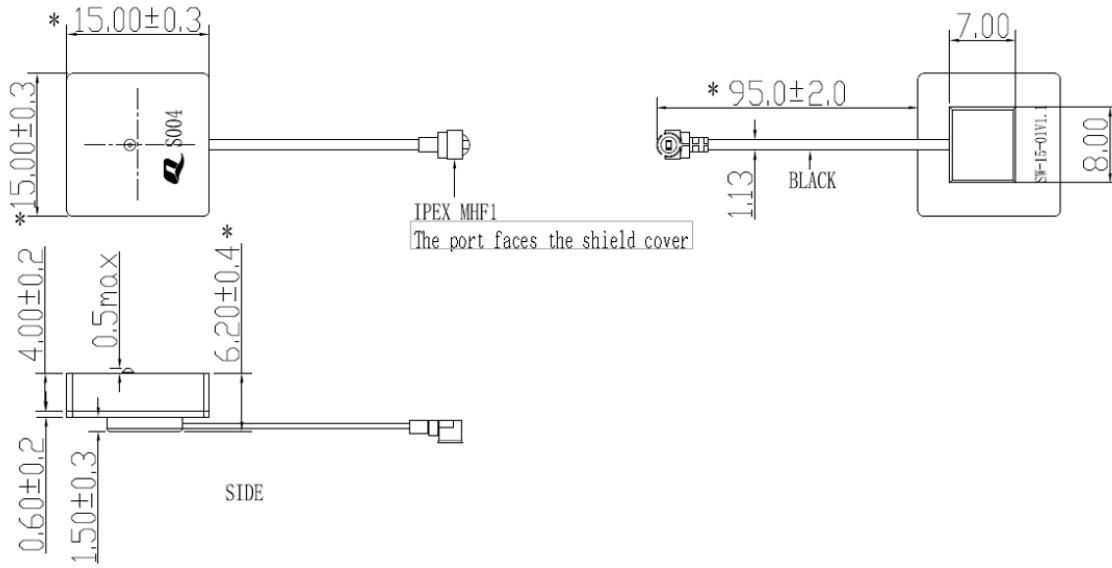

3 Detailed Performance

3.1. S-Parameter Test

3.1.1. VSWR

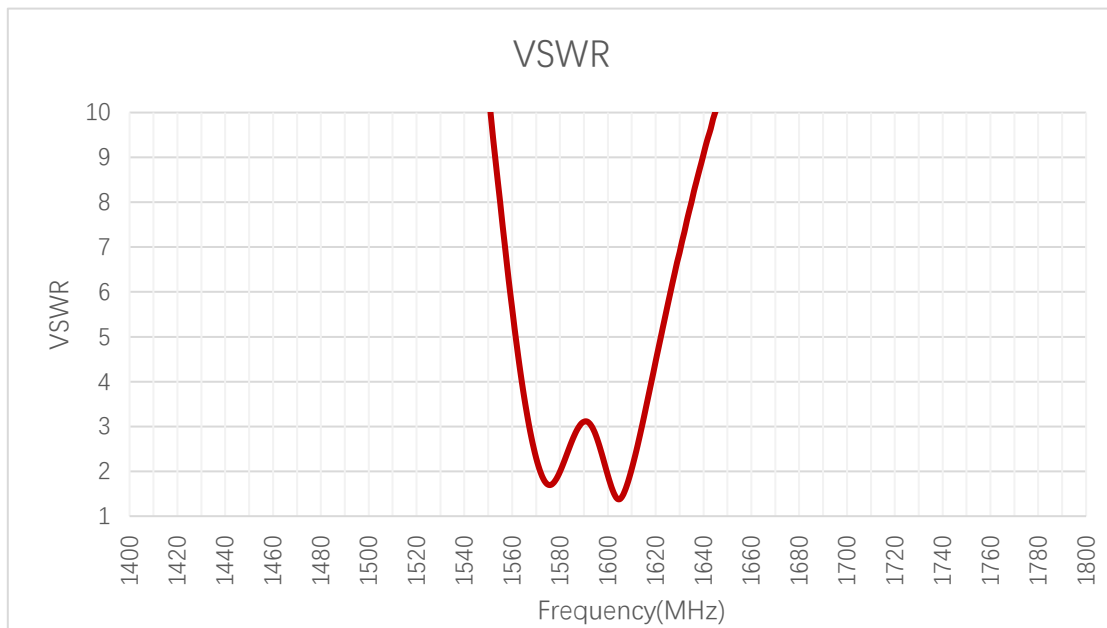

VSWR

Frequency (MHz)	1176	1207	1227	1248	1268	1561	1575	1602
VSWR	-	-	-	-	-	-	1.7	1.6

3.1.2. Return Loss

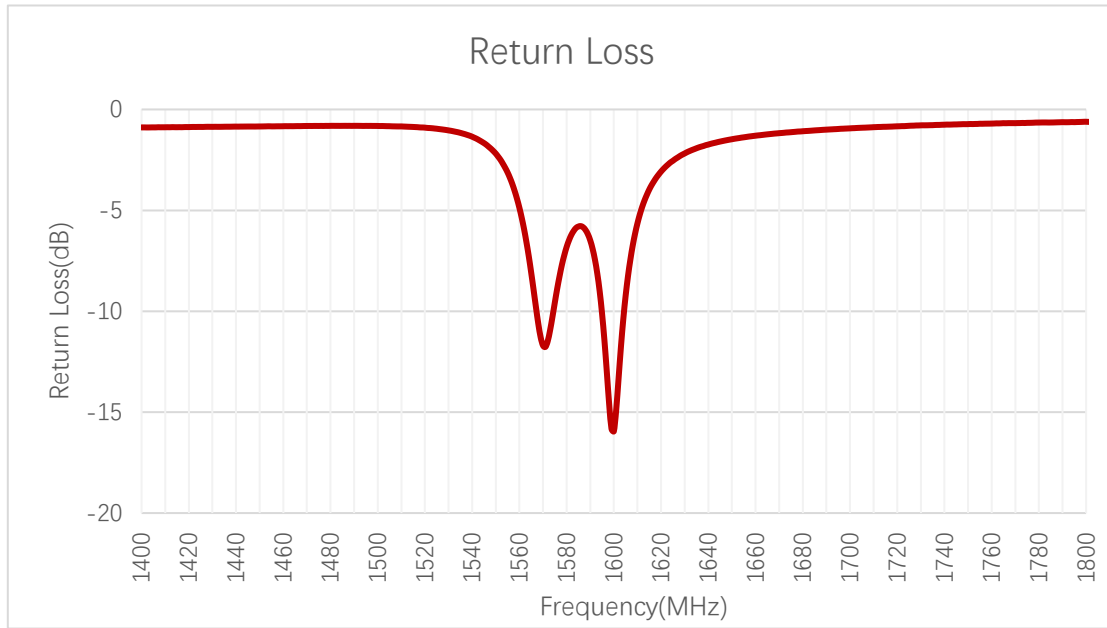

Return Loss (dB)

Frequency (MHz)	1176	1207	1227	1248	1268	1561	1575	1602
Return Loss (dB)	-	-	-	-	-	-	-11.7	-13.0

3.1.3. GNSS LNA Gain

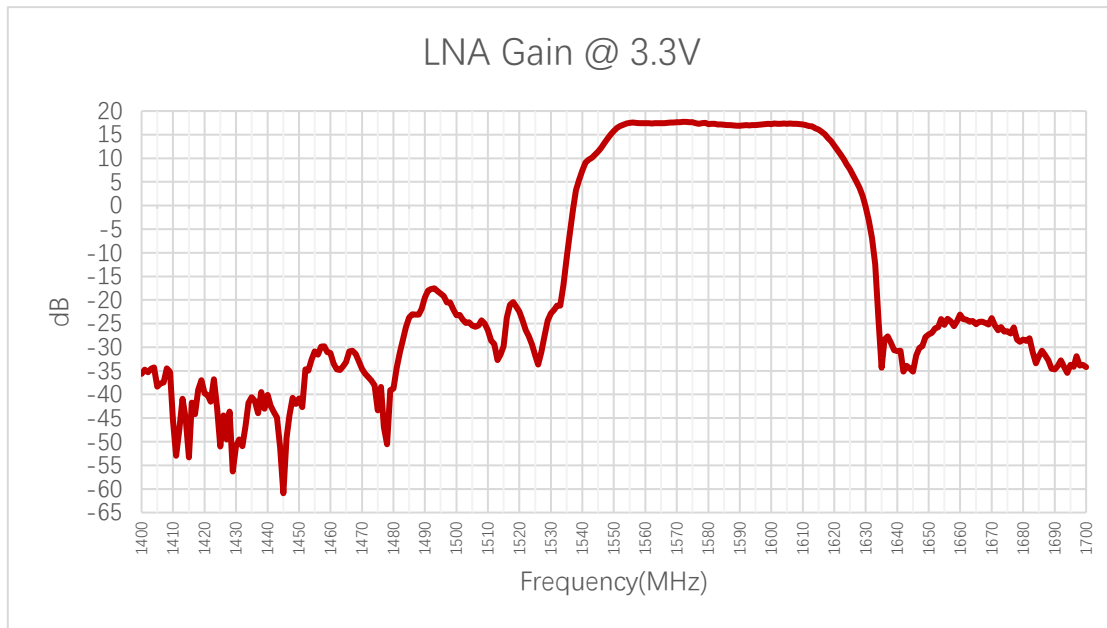

LNA Gain (dB)

Frequency (MHz)	1176	1207	1227	1248	1268	1561	1575	1602
LNA Gain (dB)	-	-	-	-	-	-	17.6	17.3

3.1.4. Noise Figure

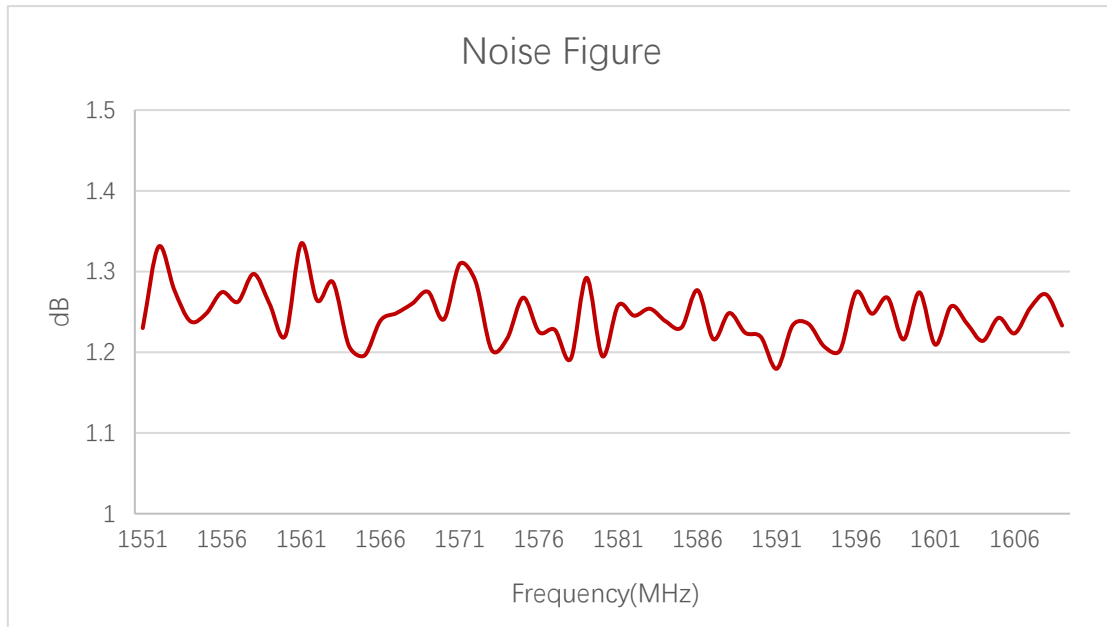

Noise Figure (dB)

Frequency (MHz)	1176	1207	1227	1248	1268	1561	1575	1602
Noise Figure (dB)	-	-	-	-	-	-	1.27	1.26

3.2. Radiation Performance Test

3.2.1. Efficiency

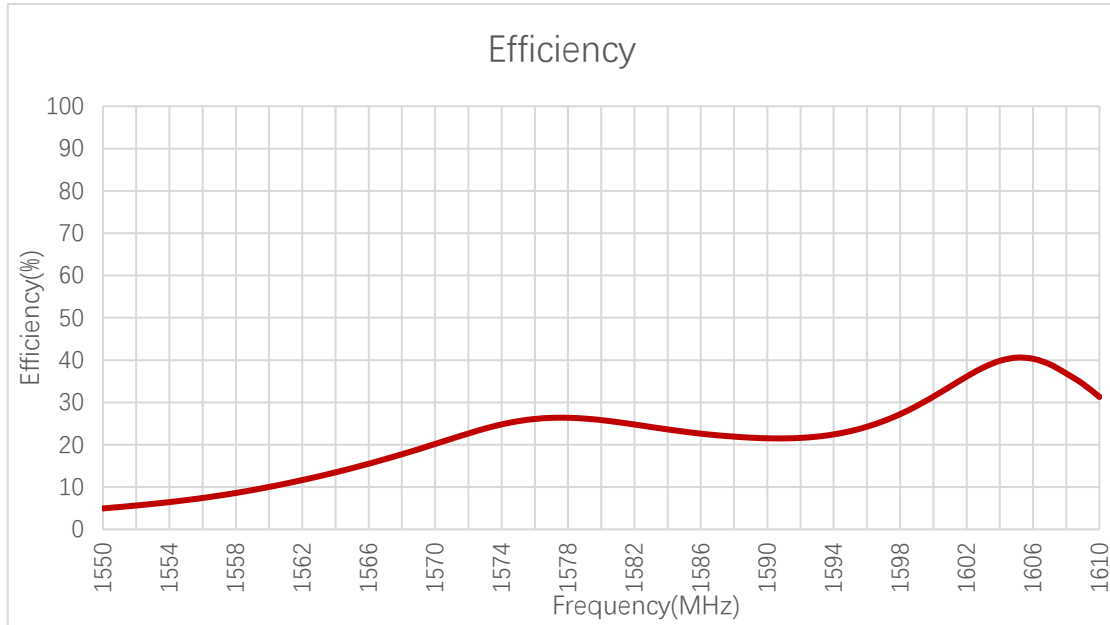

Efficiency (%)

Frequency (MHz)	1176	1207	1227	1248	1268	1561	1575	1602
Efficiency (%)	-	-	-	-	-	-	25.6	36.1

3.2.2. Peak Gain

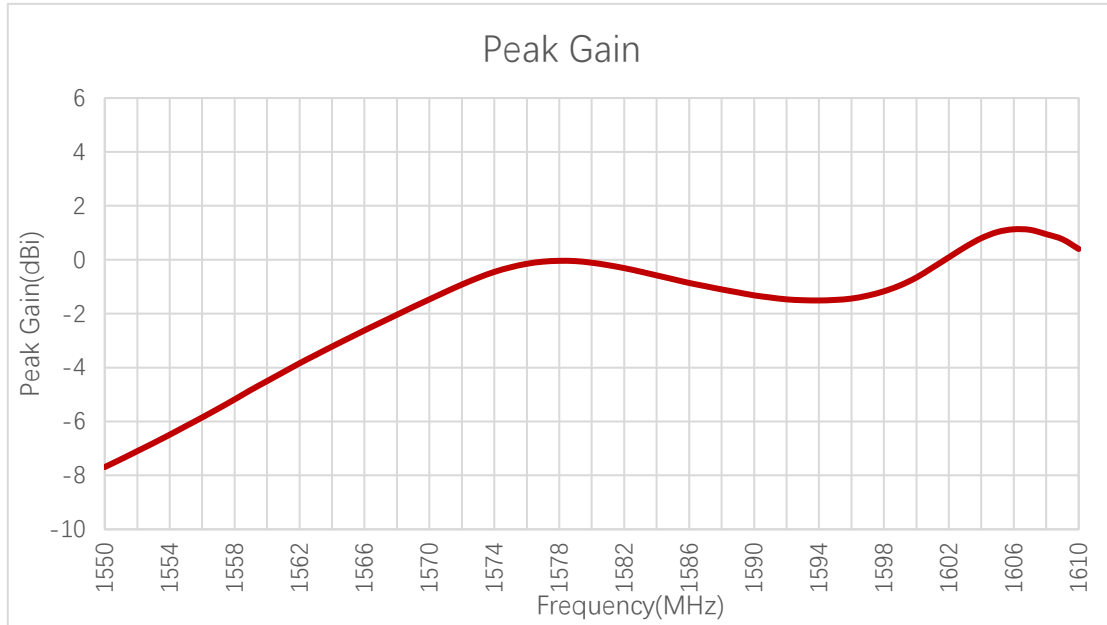

Peak Gain (dBi)

Frequency (MHz)	1176	1207	1227	1248	1268	1561	1575	1602
Peak Gain (dBi)	-	-	-	-	-	-	-0.3	0.1

3.2.3. 3D & 2D Radiation Pattern

- Test Condition: By 15 mm square ground plane.
- Test Chamber: GL-S-1

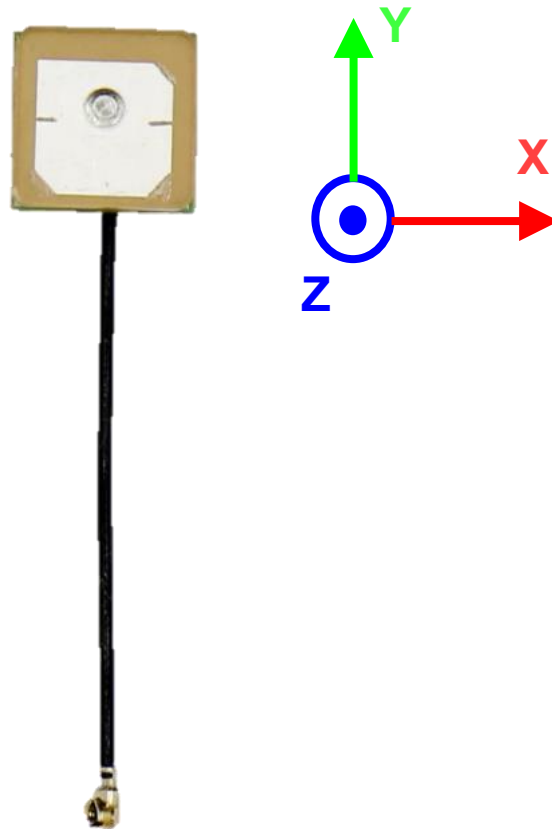

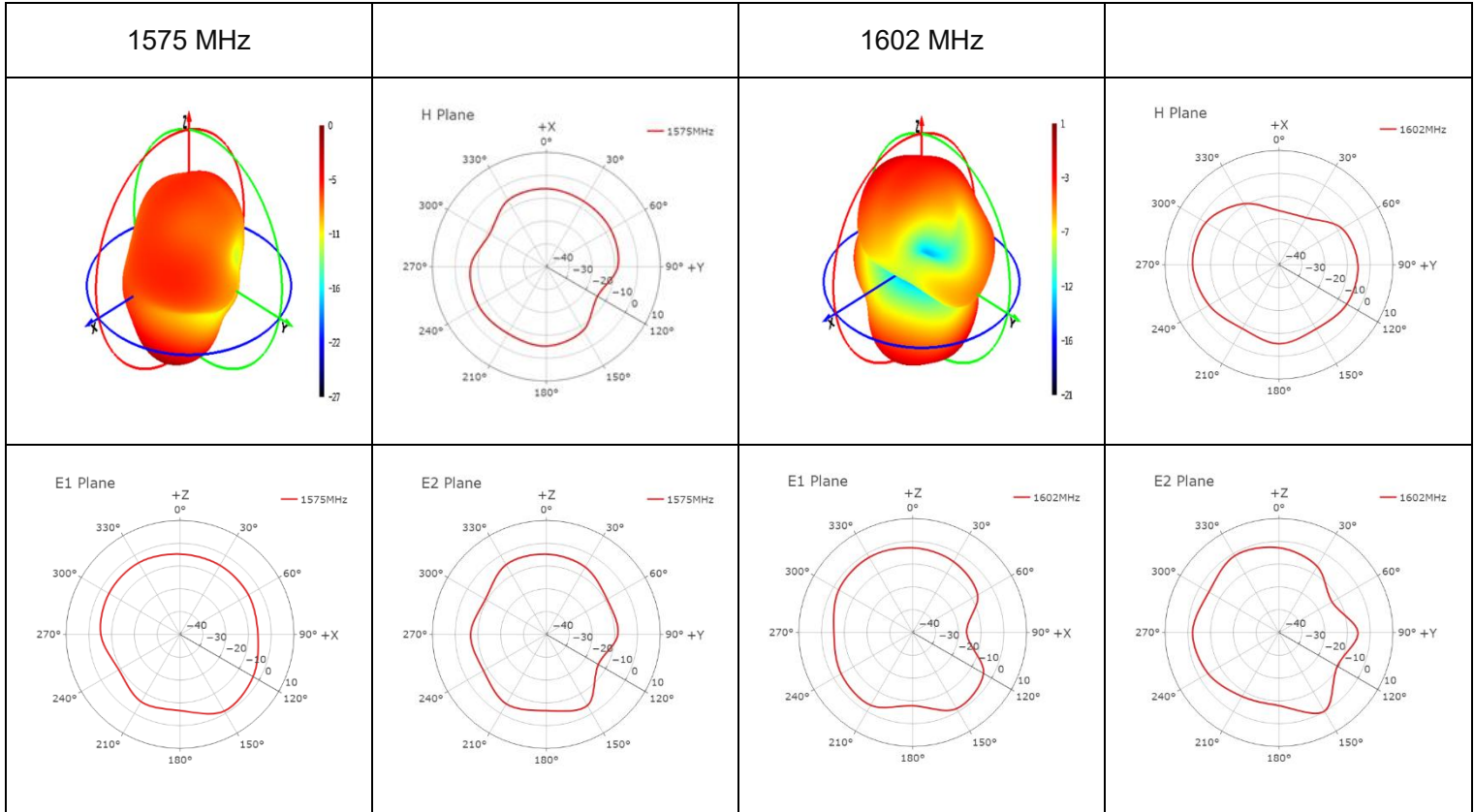

4 Packaging

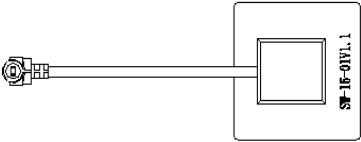
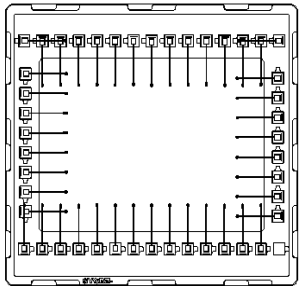
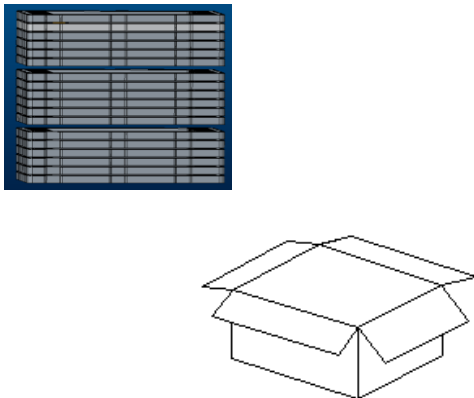
Step	Packaging Picture / 2D Picture	Description
1		Product drawing
2	 <p style="text-align: center;">x 5 pan</p>	<p>Each tray places 46 pcs of products; (46 pcs antennas per tray)</p> <p>Stack 5 layers of plastic disks, and then the product is vacuumed; (230 pcs antennas per vacuum bag)</p>
3		<p>(3 vacuum bags per carton box)</p> <p>(690 pcs antennas per carton box)</p> <p>Estimated quantity</p> <p>Unsatisfactory cases will be shipped in suitable cartons.</p> <p><u>Carton Size:</u> <u>L × W × H = 380 × 330 × 320 mm</u></p>

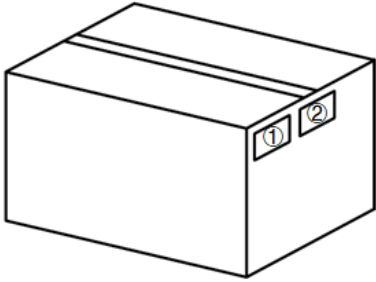
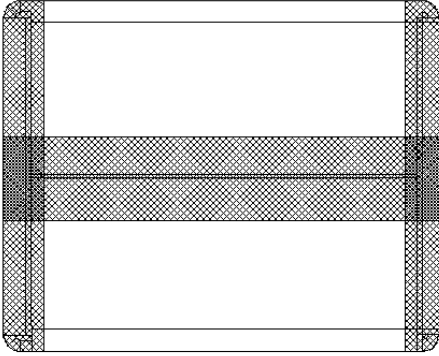
<p>4</p>		<p>Position for Attaching Labels</p> <ul style="list-style-type: none"> ① Carton Label ② Quality Label
<p>5</p>		<p>Sealing Cartons “I” type sealing cartons</p>
<p>6</p>	<p>Initial packaging plan and the final packaging method are subject to the physical supply.</p>	

Contact Us

At Quectel, our aim is to provide timely and comprehensive services to our customers. If you require any assistance, please contact our headquarters:

Quectel Wireless Solutions Co., Ltd.

Building 5, Shanghai Business Park Phase III (Area B), No.1016 Tianlin Road, Minhang District, Shanghai 200233, China

Tel: +86 21 5108 6236

Email: info@quectel.com

Or our local offices. For more information, please visit:

<http://www.quectel.com/support/sales.htm>.

For technical support, or to report documentation errors, please visit:

<http://www.quectel.com/support/technical.htm>.

Or email us at: support@quectel.com.

Legal Notices

We offer information as a service to you. The provided information is based on your requirements and we make every effort to ensure its quality. You agree that you are responsible for using independent analysis and evaluation in designing intended products, and we provide reference designs for illustrative purposes only. Before using any hardware, software or service guided by this document, please read this notice carefully. Even though we employ commercially reasonable efforts to provide the best possible experience, you hereby acknowledge and agree that this document and related services hereunder are provided to you on an “as available” basis. We may revise or restate this document from time to time at our sole discretion without any prior notice to you.

Use and Disclosure Restrictions

License Agreements

Documents and information provided by us shall be kept confidential, unless specific permission is granted. They shall not be accessed or used for any purpose except as expressly provided herein.

Copyright

Our and third-party products hereunder may contain copyrighted material. Such copyrighted material shall not be copied, reproduced, distributed, merged, published, translated, or modified without prior written consent. We and the third party have exclusive rights over copyrighted material. No license shall be granted or conveyed under any patents, copyrights, trademarks, or service mark rights. To avoid ambiguities, purchasing in any form cannot be deemed as granting a license other than the normal non-exclusive, royalty-free license to use the material. We reserve the right to take legal action for noncompliance with abovementioned requirements, unauthorized use, or other illegal or malicious use of the material.

Trademarks

Except as otherwise set forth herein, nothing in this document shall be construed as conferring any rights to use any trademark, trade name or name, abbreviation, or counterfeit product thereof owned by Quectel or any third party in advertising, publicity, or other aspects.

Third-Party Rights

This document may refer to hardware, software and/or documentation owned by one or more third parties (“third-party materials”). Use of such third-party materials shall be governed by all restrictions and obligations applicable thereto.

We make no warranty or representation, either express or implied, regarding the third-party materials, including but not limited to any implied or statutory, warranties of merchantability or fitness for a particular purpose, quiet enjoyment, system integration, information accuracy, and non-infringement of any third-party intellectual property rights with regard to the licensed technology or use thereof. Nothing herein constitutes a representation or warranty by us to either develop, enhance, modify, distribute, market, sell, offer for sale, or otherwise maintain production of any our products or any other hardware, software, device, tool, information, or product. We moreover disclaim any and all warranties arising from the course of dealing or usage of trade.

Privacy Policy

To implement module functionality, certain device data are uploaded to Quectel's or third-party's servers, including carriers, chipset suppliers or customer-designated servers. Quectel, strictly abiding by the relevant laws and regulations, shall retain, use, disclose or otherwise process relevant data for the purpose of performing the service only or as permitted by applicable laws. Before data interaction with third parties, please be informed of their privacy and data security policy.

Disclaimer

- a) We acknowledge no liability for any injury or damage arising from the reliance upon the information.
- b) We shall bear no liability resulting from any inaccuracies or omissions, or from the use of the information contained herein.
- c) While we have made every effort to ensure that the functions and features under development are free from errors, it is possible that they could contain errors, inaccuracies, and omissions. Unless otherwise provided by valid agreement, we make no warranties of any kind, either implied or express, and exclude all liability for any loss or damage suffered in connection with the use of features and functions under development, to the maximum extent permitted by law, regardless of whether such loss or damage may have been foreseeable.
- d) We are not responsible for the accessibility, safety, accuracy, availability, legality, or completeness of information, advertising, commercial offers, products, services, and materials on third-party websites and third-party resources.

Copyright © Quectel Wireless Solutions Co., Ltd. 2023. All rights reserved.

Revision History

Version	Date	Author	Note
-	2021-06-04	Kenny YIN/ Aria CHU	Creation of the document
1	2021-06-04	Kenny YIN/ Aria CHU	First official release
1.1	2021-06-23	Kenny YIN/ Aria CHU	Added the LNA electrical properties (Chapter 3).
1.2	2021-11-30	Kenny YIN/ Aria CHU	Updated the product description (Chapter 1).
2.0	2021-12-08	Xiaodong YANG	Updated all test data in this datasheet.
2.1	2023-08-14	Blake XIANG	Updated the drawing (Chapter 5).
3.0	2023-09-04	Tina GAN/ Lucky FENG/ David LIU/ Aria CHU	Updated all test data in this datasheet.

QUECTEL

www.quectel.com