



# Antenna Datasheet

**Product OC:** YC0001CA

**Version:** 2.0

**Date:** 2023-02-08

**Status:** Released

**Product Name:** 4G SMD Antenna

**Key Features:**

Optimized for 4G/LTE/LTE-M/NB-IoT networks

High-efficiency, multiband SMD antenna

Low-profile antenna

Frequency band: 700–960 MHz, 1710–2700 MHz

Peak efficiency: 72.9%

Dimensions: 35.0 × 8.5 × 3.0 mm

SMD-supplied tape and reel

RoHS and REACH compliant

# Overview

- **Introduction**

This wideband LTE/cellular/CDMA SMT antenna is suitable for 4G/3G/2G applications. Operating at 700–960 MHz, 1710–2700 MHz, it's a high-efficiency antenna which is mounted to the device host PCB using conventional PCB reflow process. It's ideal for all 4G/LTE applications, and also supports worldwide Cat M and NB-IoT frequency bands. Supplied on tape and reel for high-volume applications, it is compatible with all Quectel's 4G/3G/2G including LPWA modules. We provide comprehensive antenna design support such as simulation, testing and manufacturing for custom antenna solutions to meet your specific application needs.

# Contents

Overview .....	1
Contents.....	2
<b>1 Specification.....</b>	<b>3</b>
1.1. Electrical.....	3
1.2. Supported Bands.....	4
1.3. Mechanical, Environmental & Storage.....	6
<b>2 Drawing .....</b>	<b>7</b>
<b>3 Detailed Performance .....</b>	<b>9</b>
3.1. S-Parameter Test.....	9
3.1.1. VSWR.....	9
3.1.2. Return Loss .....	10
3.2. Radiation Performance Test .....	11
3.2.1. Efficiency .....	11
3.2.2. Average Gain.....	12
3.2.3. Peak Gain.....	13
3.2.4. 3D & 2D Radiation Pattern .....	14
<b>4 Schematic Symbol and Pin Definition .....</b>	<b>18</b>
<b>5 Transmission Line .....</b>	<b>19</b>
<b>6 Recommended PCB Layout .....</b>	<b>20</b>
<b>7 Matching Circuit .....</b>	<b>22</b>
<b>8 Soldering Temperature .....</b>	<b>23</b>
<b>9 Reflow Profile .....</b>	<b>24</b>
<b>10 Packaging .....</b>	<b>25</b>
<b>Contact Us .....</b>	<b>26</b>
<b>Legal Notices .....</b>	<b>27</b>
<b>Revision History .....</b>	<b>29</b>

# 1 Specification

Test Condition: Assembled On 121.4 × 65 mm EVB

## 1.1. Electrical

Electrical	
Frequency Range	700–960 MHz, 1710–2700 MHz
Impedance	50 Ω
Polarization	Linear
Radiation Pattern	Omni-directional

Electrical - Detail									
SPEC	Band	Band	B71	B12 /B13 /B28	B5 /B8 /B26	B1 /B2 /B3	B40	WIFI 2G	B38 /B41
	Band	Freq. (MHz)	600 – 700	700 – 810	820 – 960	1700 – 2170	2300 – 2400	2400 – 2500	2500 – 2690
Max VSWR	On 121.4 × 65 mm EVB		-	5.8	6.7	3.8	1.4	1.4	1.4
Max Return Loss(dB)	On 121.4 × 65 mm EVB		-	-3.0	-2.6	-4.6	-16.1	-15.2	-15.0
AVG Eff. (%)	On 121.4 × 65 mm EVB		-	25.5	25.4	58.2	64.8	67.2	70.7
AVG AVG Gain (dB)	On 121.4 × 65 mm EVB		-	-6.0	-6.0	-2.4	-1.9	-1.7	-1.5
Max Peak Gain (dBi)	On 121.4 × 65 mm EVB		-	-2.6	-2.6	2.6	2.7	2.5	2.7
VSWR	On 121.4 × 65 mm EVB					≤ 6.7			

Return Loss	On 121.4 × 65 mm EVB	≤ -2.6 dB
Peak Gain	On 121.4 × 65 mm EVB	≤ 2.7 dBi

## 1.2. Supported Bands

5G NR / LTE / LTE-Advanced / WCDMA / HSPA / HSPA+ / GPRS / GSM / NB-IoT				
Band	Frequency (MHz)	Uplink (MHz)	Downlink (MHz)	Covered
1	2100	1920–1980	2110–2170	√
2	1900	1850–1910	1930–1990	√
3	1800	1710–1785	1805–1880	√
4	1700	1710–1755	2110–2155	√
5	850	824–849	869–894	√
7	2600	2500–2570	2620–2690	√
8	900	880–915	925–960	√
9	1800	1749.9–1784.9	1844.9–1879.9	√
11	1500	1427.9–1447.9	1475.9–1495.9	-
12	700	699–716	729–746	√
13	700	777–787	746–756	√
14	700	788–798	758–768	√
17	700	704–716	734–746	√
18	850	815–830	860–875	√
19	850	830–845	875–890	√
20	800	832–862	791–821	√
21	1500	1447.9–1462.9	1495.9–1510.9	-
22	3500	3410–3490	3510–3590	-
23	2100	2000–2020	2180–2200	√
24	1600	1626.5–1660.5	1525–1559	-

25	1900	1850–1915	1930–1995	√
26	850	814–849	859–894	√
28	700	703–748	758–803	√
31	450	452.5–457.5	462.5–467.5	-
34	2100	2010–2025		√
38	2600	2570–2620		√
39	1900	1880–1920		√
40	2300	2300–2400		√
41	2500	2496–2690		√
42	3500	3400–3600		-
48	3500	3550–3700		-
66	1700	1710–1780	2110–2200	√
71	600	663–698	617–652	-
74	1500	1427–1470	1475–1518	-
77	3500	3300–4200		-
78	3500	3300–3800		-
79	4500	4400–5000		-

**Note:**

- Covered √ means efficiency > 20%.
- Based on 121.4 × 65 mm EVB.

### 1.3. Mechanical, Environmental & Storage

Mechanical	
Antenna Size	35.0 × 8.5 × 3.0 mm
Antenna Material & Color	FR4 & Black
Antenna Weight	Typ. 1.9 g
Mounting Type	SMD
Recommended EVB Size	121.4 × 65 mm
Environmental	
Operation Temperature	-40 °C to +85 °C
RoHS & REACH Compliant	Yes

# 2 Drawing

ROHS

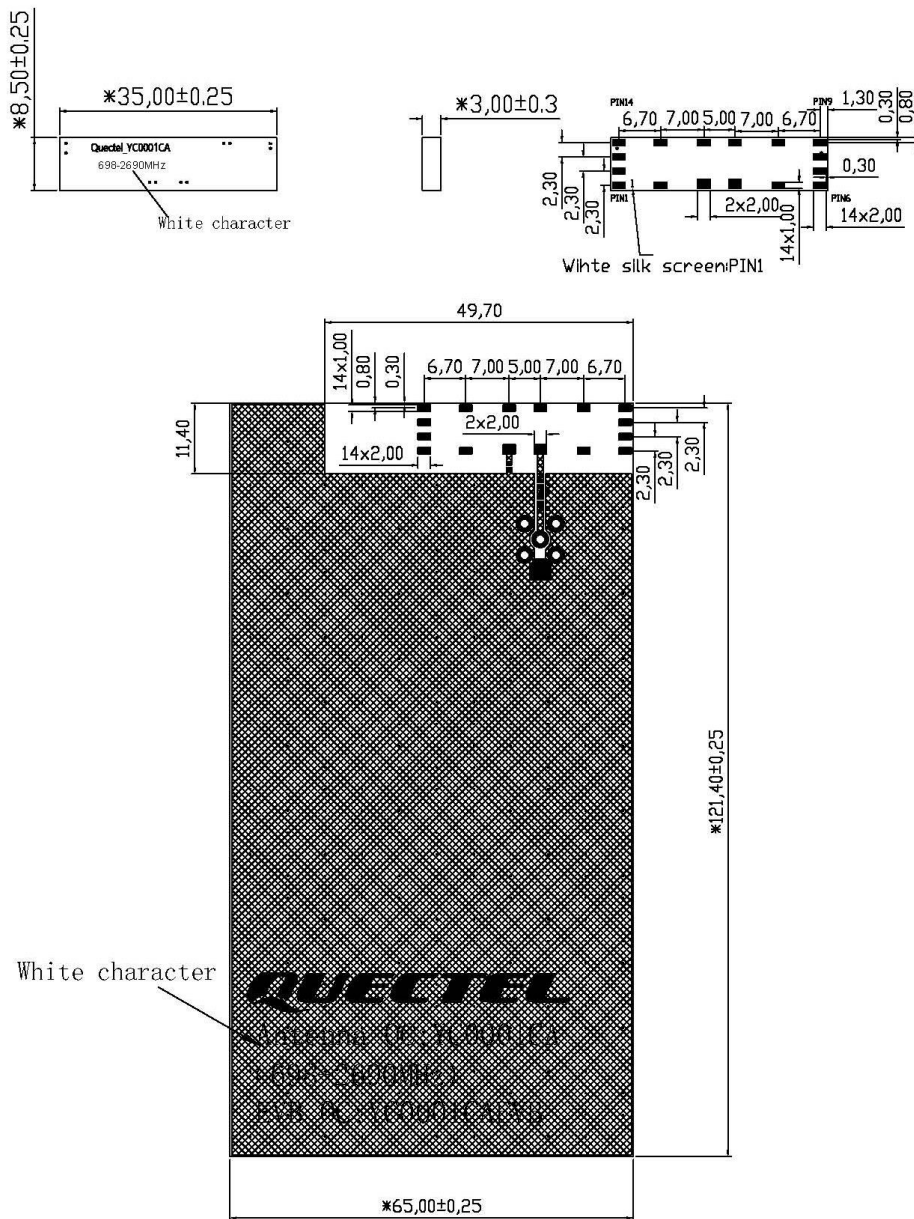



	Name	Material	Brand	QTY	Model
1	Antenna	FR4 3.0t	Quectel	1	YC0001CA
2	PCB	FR4 1.0t	Quectel	1	YC0001CAEVB
3	SMA Female Connector	Brass	Quectel	1	
4	2.4pF(0402)	Ceramics	Murata	1	
5	3nH (0402)	Ceramics	Murata	1	
6	7.5nH (0402)	Ceramics	Murata	1	
7	0.5pF (0402)	Ceramics	Murata	1	

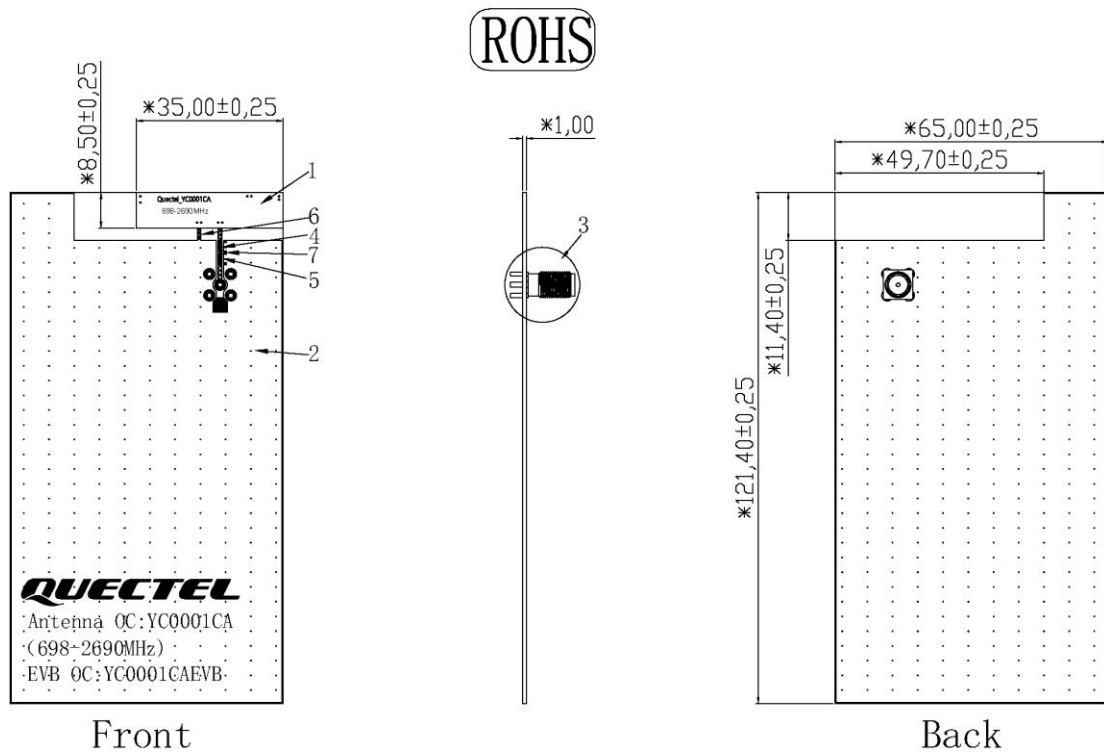

# 3 Detailed Performance

## 3.1. S-Parameter Test

### 3.1.1. VSWR

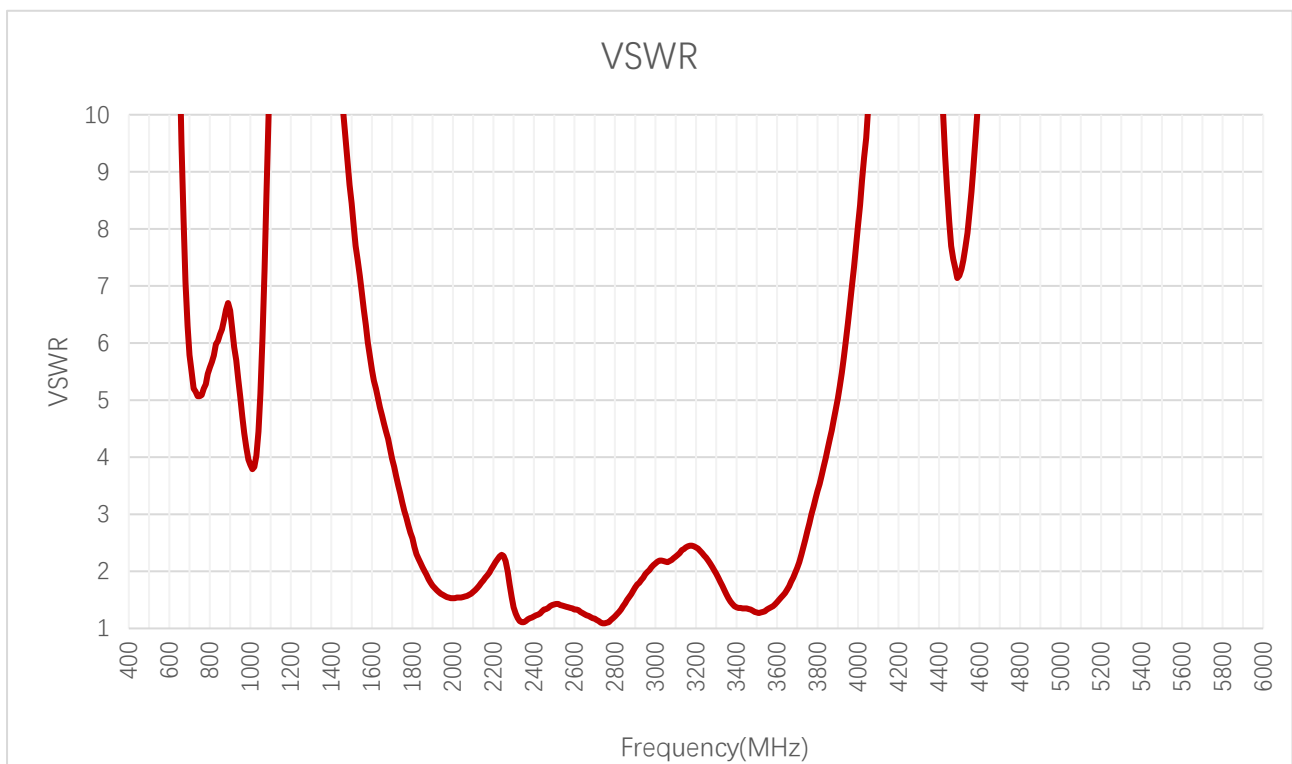

**VSWR**

Frequency (MHz)	600	700	710	830	900	960	1440	1710	1740	1880
On 121.5 × 65 mm EVB	-	5.8	5.5	6.0	6.6	4.7	-	3.8	3.4	1.9
Frequency (MHz)	1950	2140	2350	2450	2600	2690	4700	5000	5500	6000
On 121.5 × 65 mm EVB	1.6	1.8	1.1	1.3	1.3	1.2	-	-	-	-

**3.1.2. Return Loss**

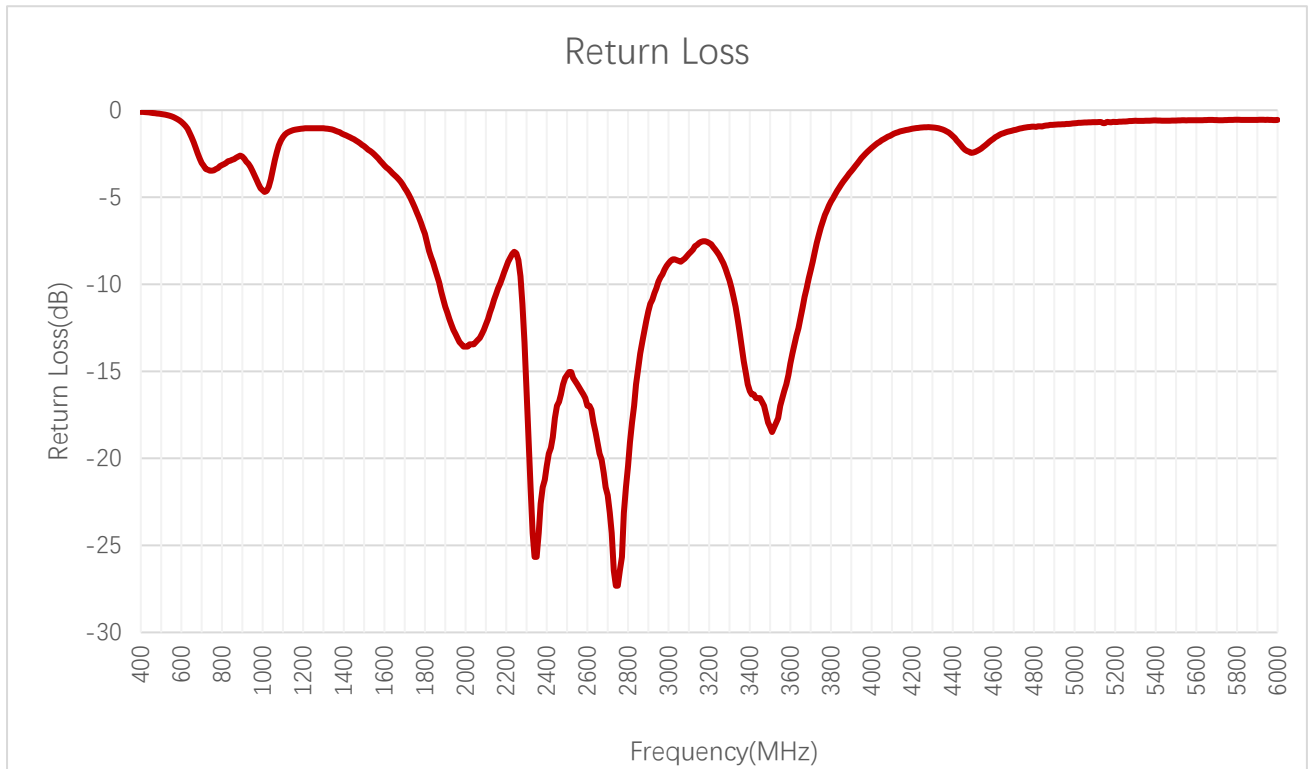

**Return Loss (dB)**

Frequency (MHz)	600	700	710	830	900	960	1440	1710	1740	1880
On 121.5 × 65 mm EVB	-	-3.0	-3.2	-2.9	-2.7	-3.7	-	-4.6	-5.3	-10.4
Frequency (MHz)	1950	2140	2350	2450	2600	2690	4700	5000	5500	6000
On 121.5 × 65 mm EVB	-12.8	-10.9	-25.7	-17.0	-17.0	-21.7	-	-	-	-

### 3.2. Radiation Performance Test

#### 3.2.1. Efficiency

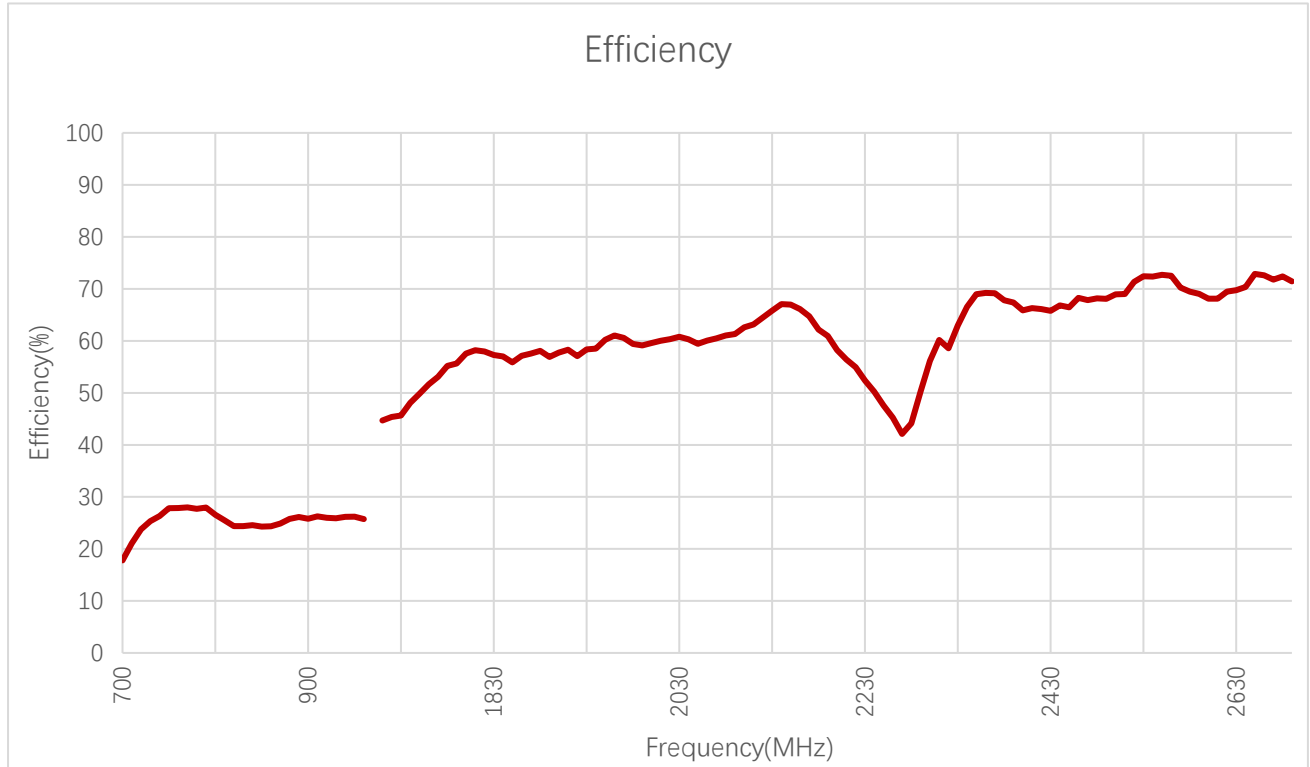

**Efficiency (%)**

Frequency (MHz)	600	700	710	830	900	960	1440	1710	1740	1880
On 121.5 × 65 mm EVB	-	17.8	21.1	24.4	25.8	25.7	-	44.7	48.1	58.1
Frequency (MHz)	1950	2140	2350	2450	2600	2690	4700	5000	5500	6000
On 121.5 × 65 mm EVB	60.2	67.1	69.0	66.5	68.1	71.5	-	-	-	-

**3.2.2. Average Gain**

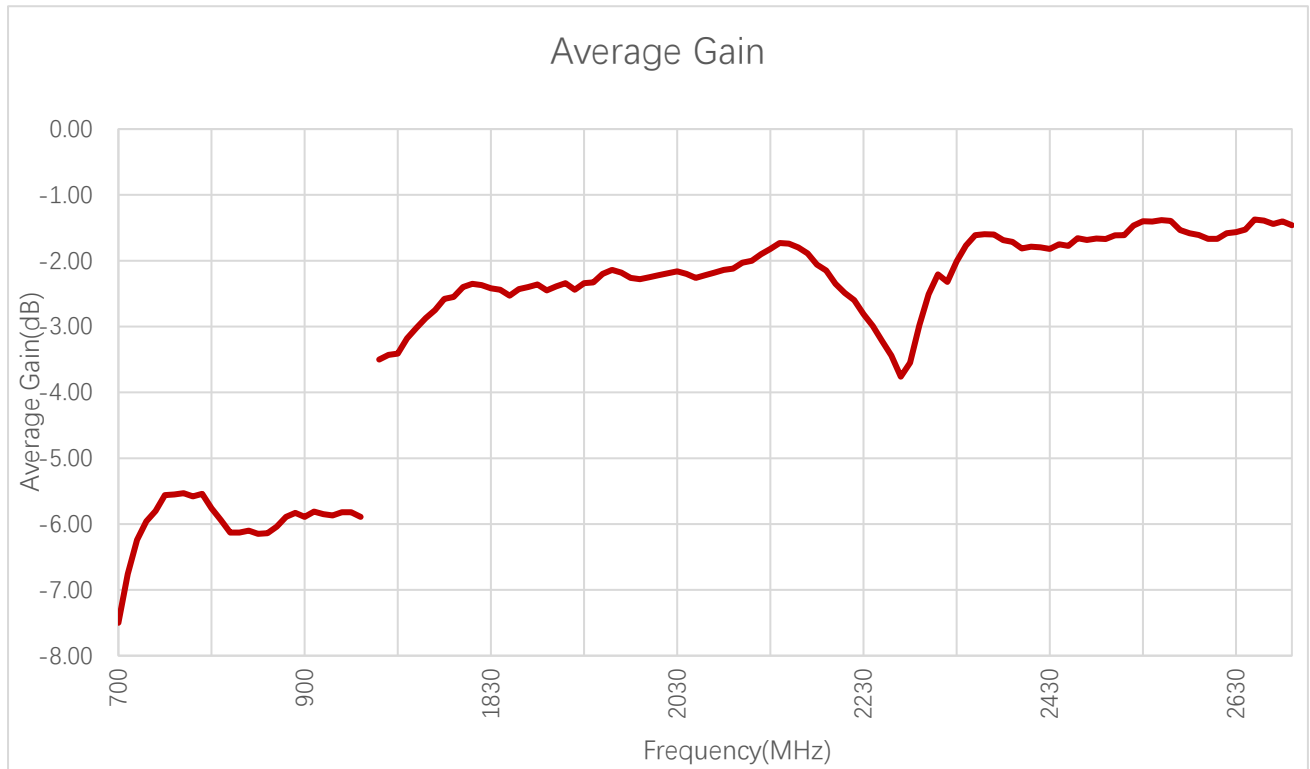

**Average Gain (dB)**

Frequency (MHz)	600	700	710	830	900	960	1440	1710	1740	1880
On 121.5 × 65 mm EVB	-	-7.5	-6.8	-6.1	-5.9	-5.9	-	-3.5	-3.2	-2.4
Frequency (MHz)	1950	2140	2350	2450	2600	2690	4700	5000	5500	6000
On 121.5 × 65 mm EVB	-2.2	-1.7	-1.6	-1.8	-1.7	-1.5	-	-	-	-

**3.2.3. Peak Gain**

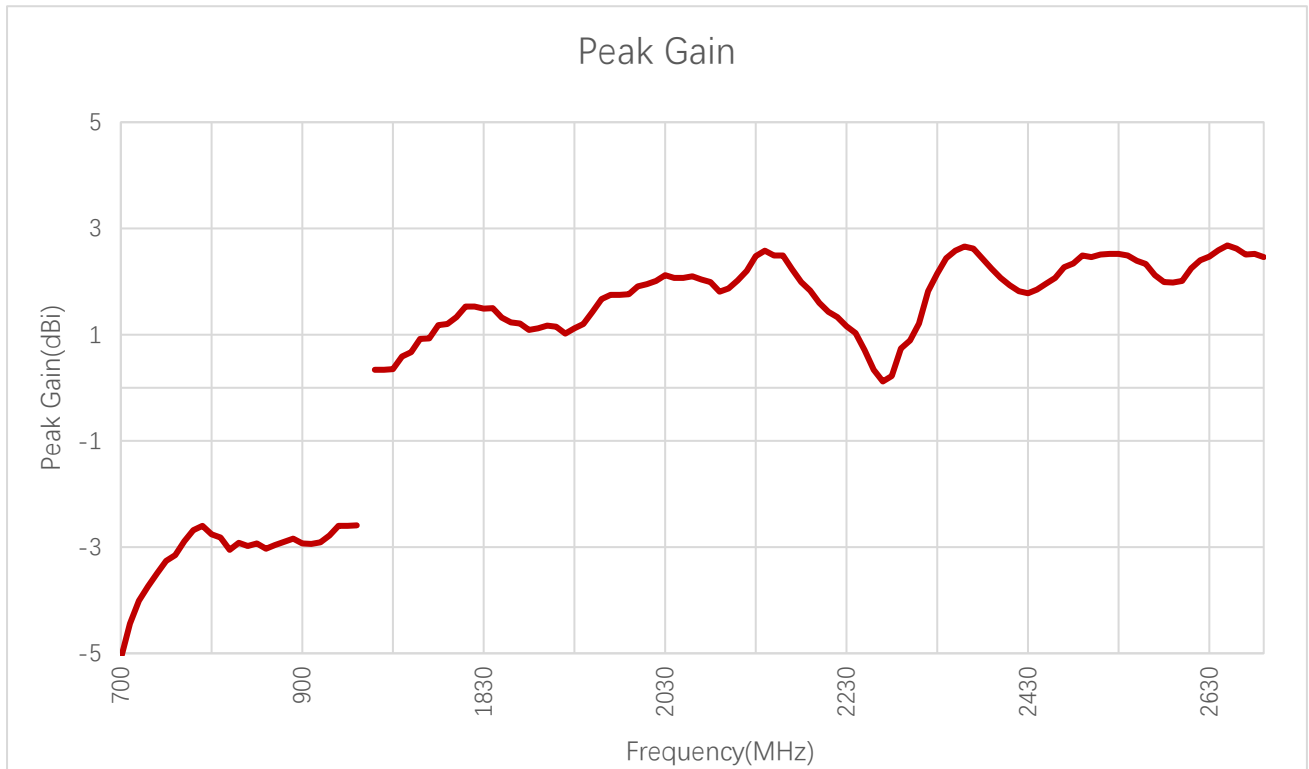

**Peak Gain (dBi)**

Frequency (MHz)	600	700	710	830	900	960	1440	1710	1740	1880
On 121.5 × 65 mm EVB	-	-5.1	-4.4	-2.9	-2.9	-2.6	-	0.3	0.6	1.1
Frequency (MHz)	1950	2140	2350	2450	2600	2690	4700	5000	5500	6000
On 121.5 × 65 mm EVB	1.4	2.6	2.6	2.0	2.0	2.5	-	-	-	-

### 3.2.4. 3D & 2D Radiation Pattern

- Test Status: Assembled on 121.4 × 65 mm EVB
- Test Chamber: HF-G-1

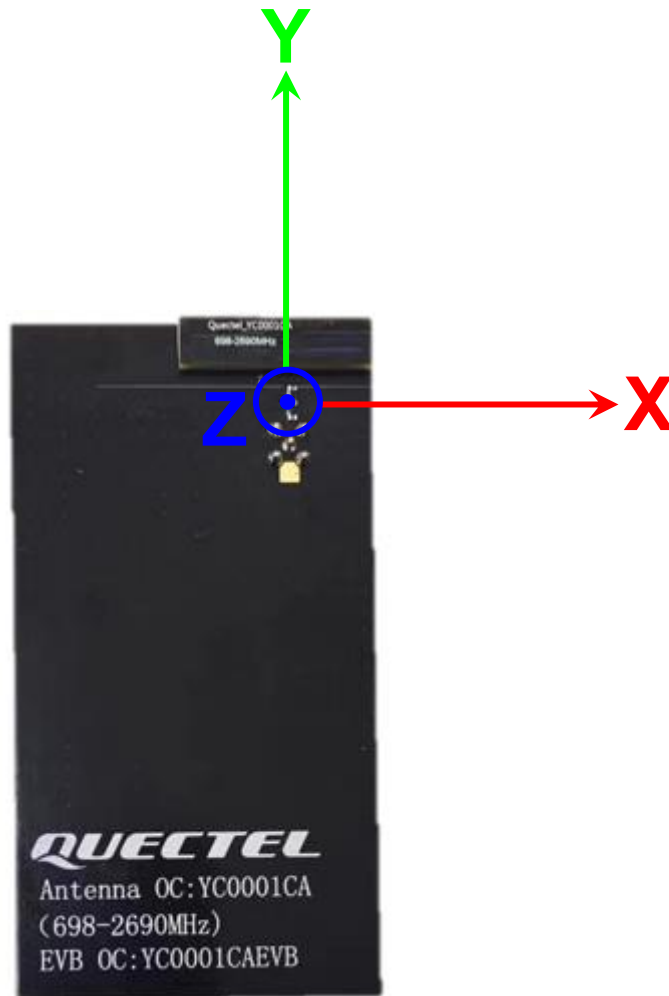

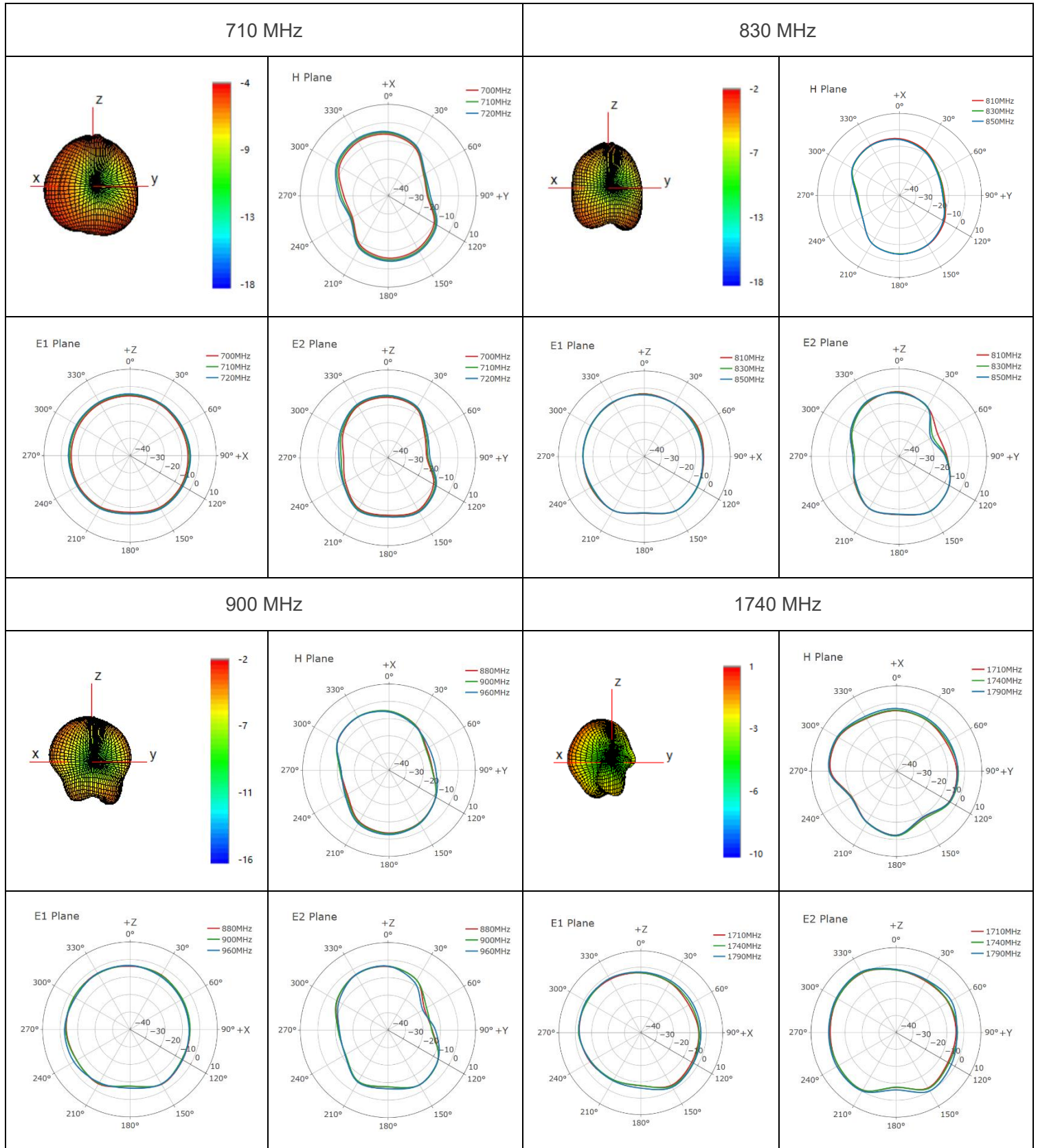



**1880 MHz**

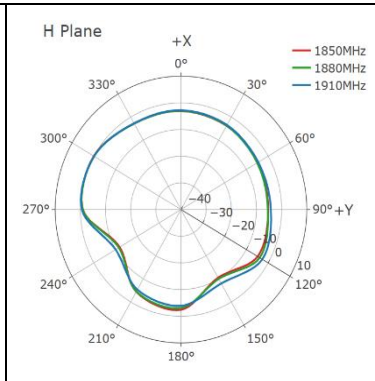
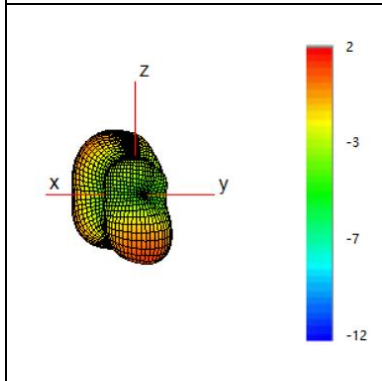

**1950 MHz**

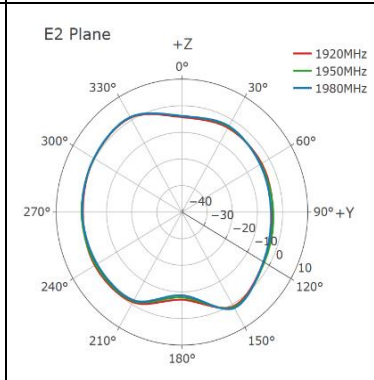
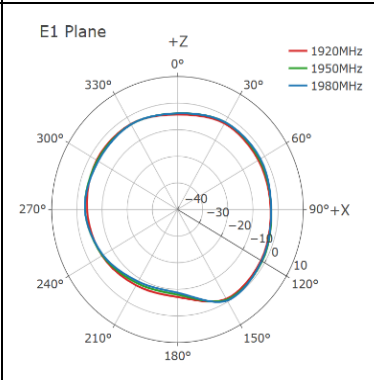
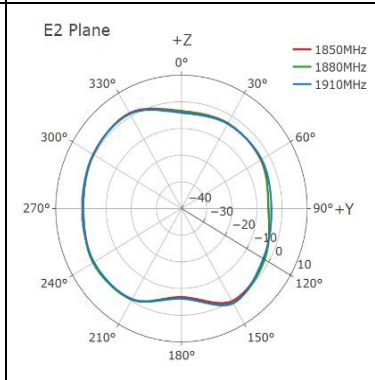
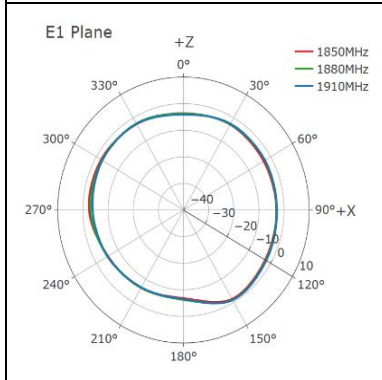
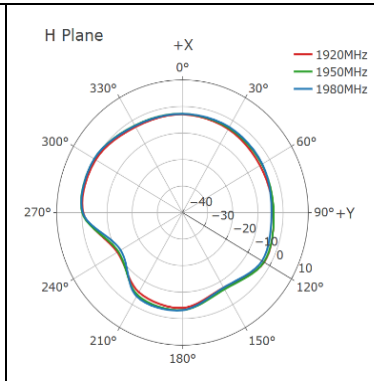
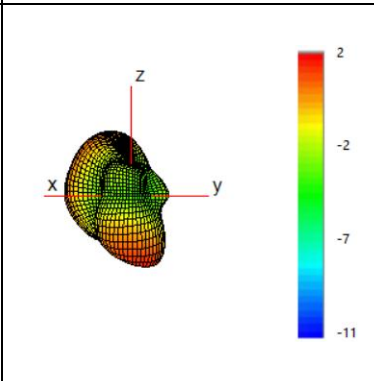

**2140 MHz**

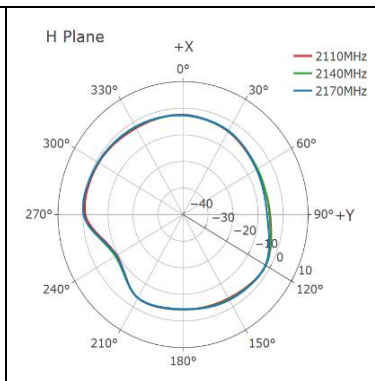
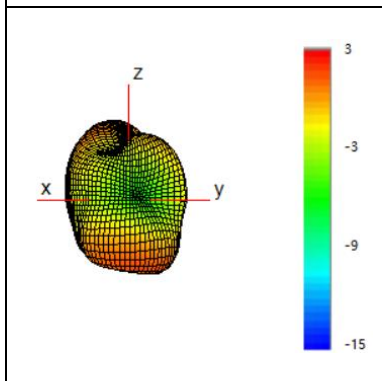

**2350 MHz**

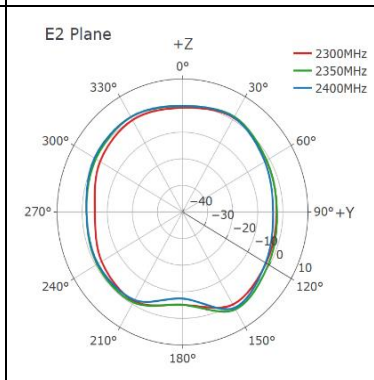
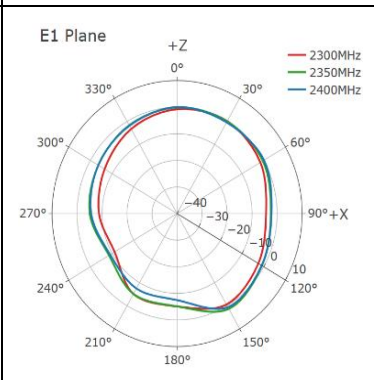
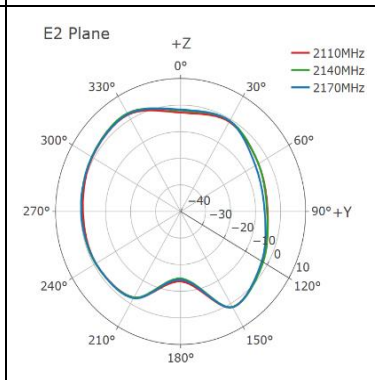
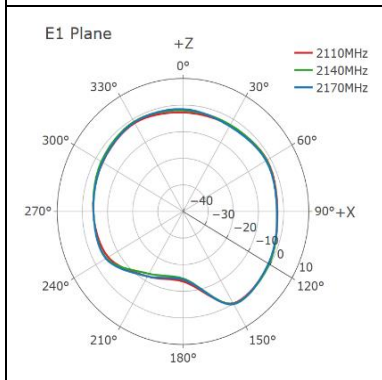
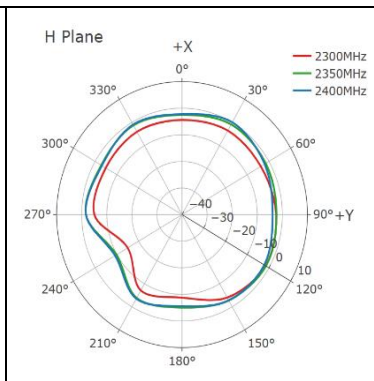
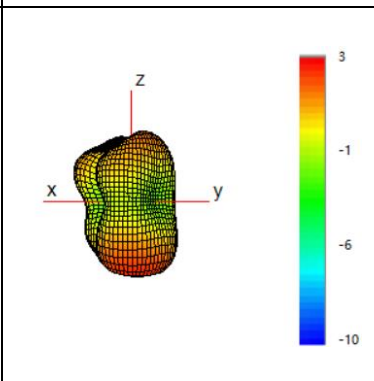

2600 MHz

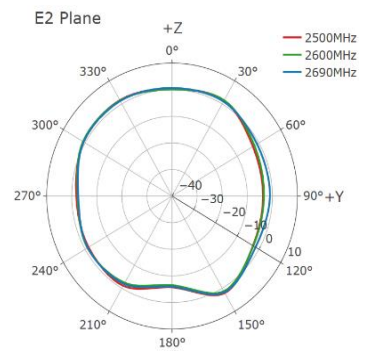
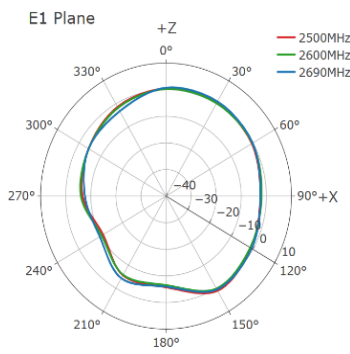
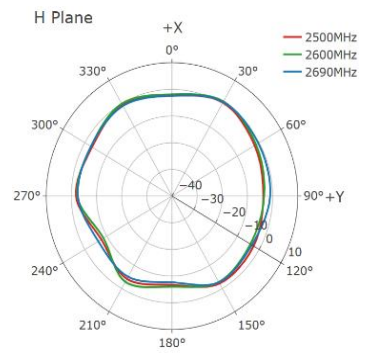
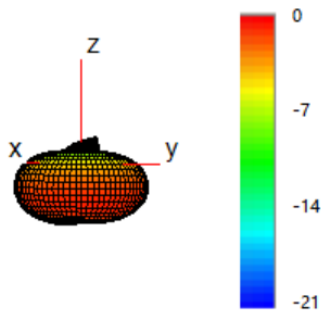

# 4 Schematic Symbol and Pin Definition

- The pin assignment for the antenna is as follows.
- The antenna has 16 pins and only two work.
- All other pins are designed for mechanical strength.

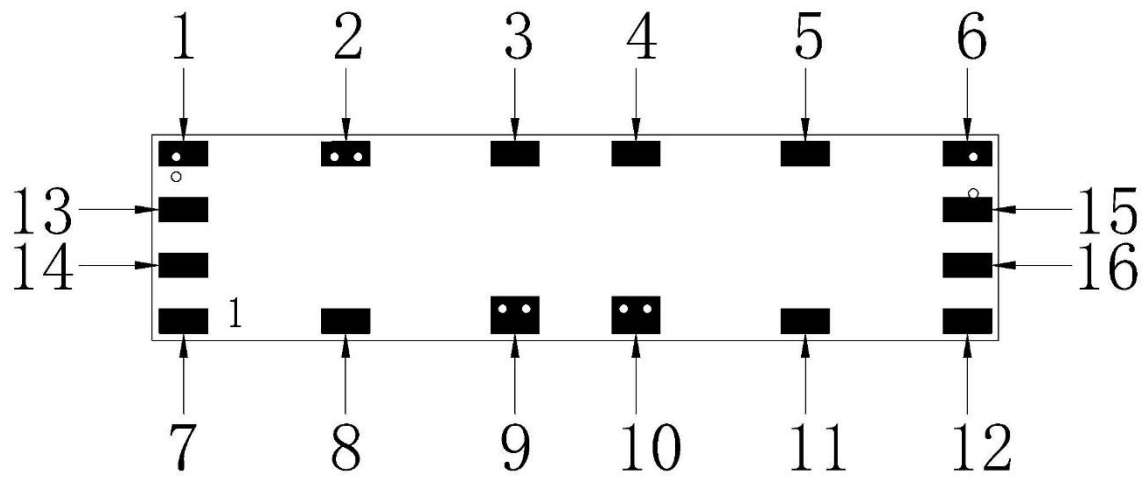

Front:Perspective View

Pin No.	Description
10	Return / GND
9	FEED
1, 2, 3, 4, 5, 6, 7, 8, 11, 12, 13, 14, 15, 16	Not used (Mechanical only)

## 5 Transmission Line

The characteristic impedance of all transmission lines shall be designed as 50  $\Omega$ .

- The length of the transmission lines should be kept as short as possible.
- Any other part of the RF system, such as transceiver, power amplifiers, etc., shall also be designed with an impedance of 50  $\Omega$ .

Once the material for the PCB has been chosen (PCB thickness and dielectric constant), a coplanar transmission line can easily be designed using any of the commercial software packages for transmission line design. For the chosen PCB thickness, copper thickness and substrate dielectric constant, the program will calculate the appropriate transmission line width and gaps on either side of the track so the characteristic impedance of the coplanar transmission is 50  $\Omega$ .

# 6 Recommended PCB Layout

- Test EVB Size: 121.4 mm × 65 mm
- EVB Clearance Area: 11.4 mm × 49.7 mm

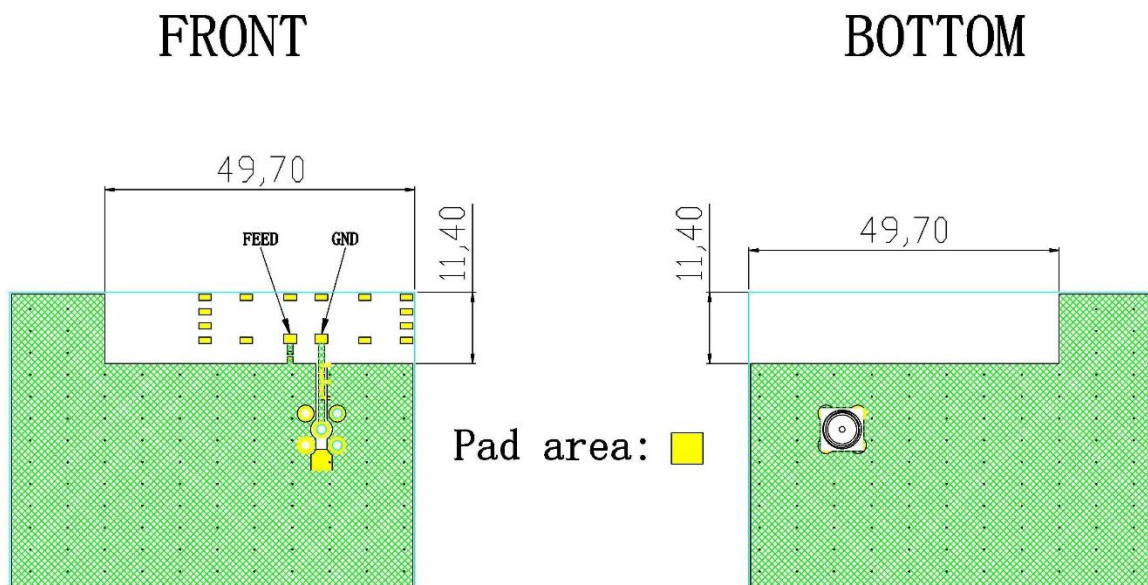

- Front Layout Details

Pad area: ■

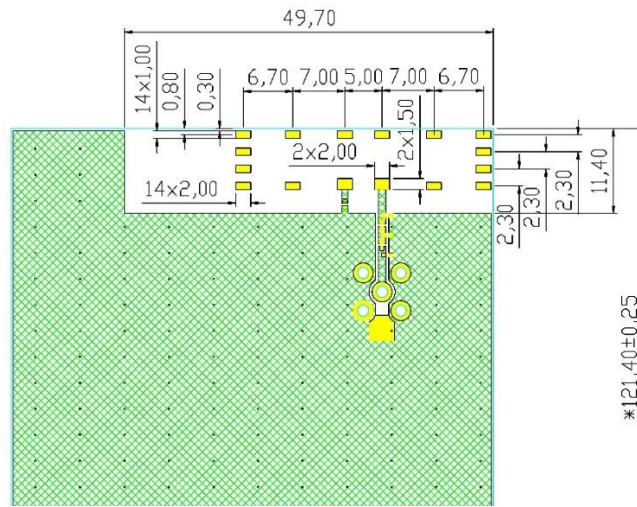

- Antenna Pad

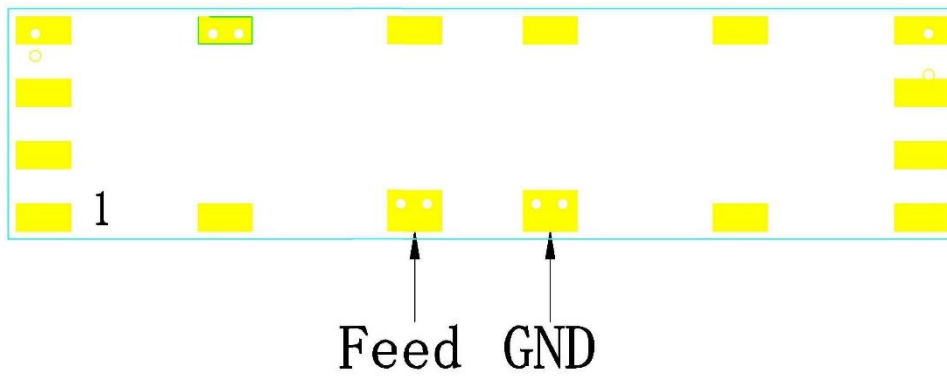

Front:Perspective View

# 7 Matching Circuit

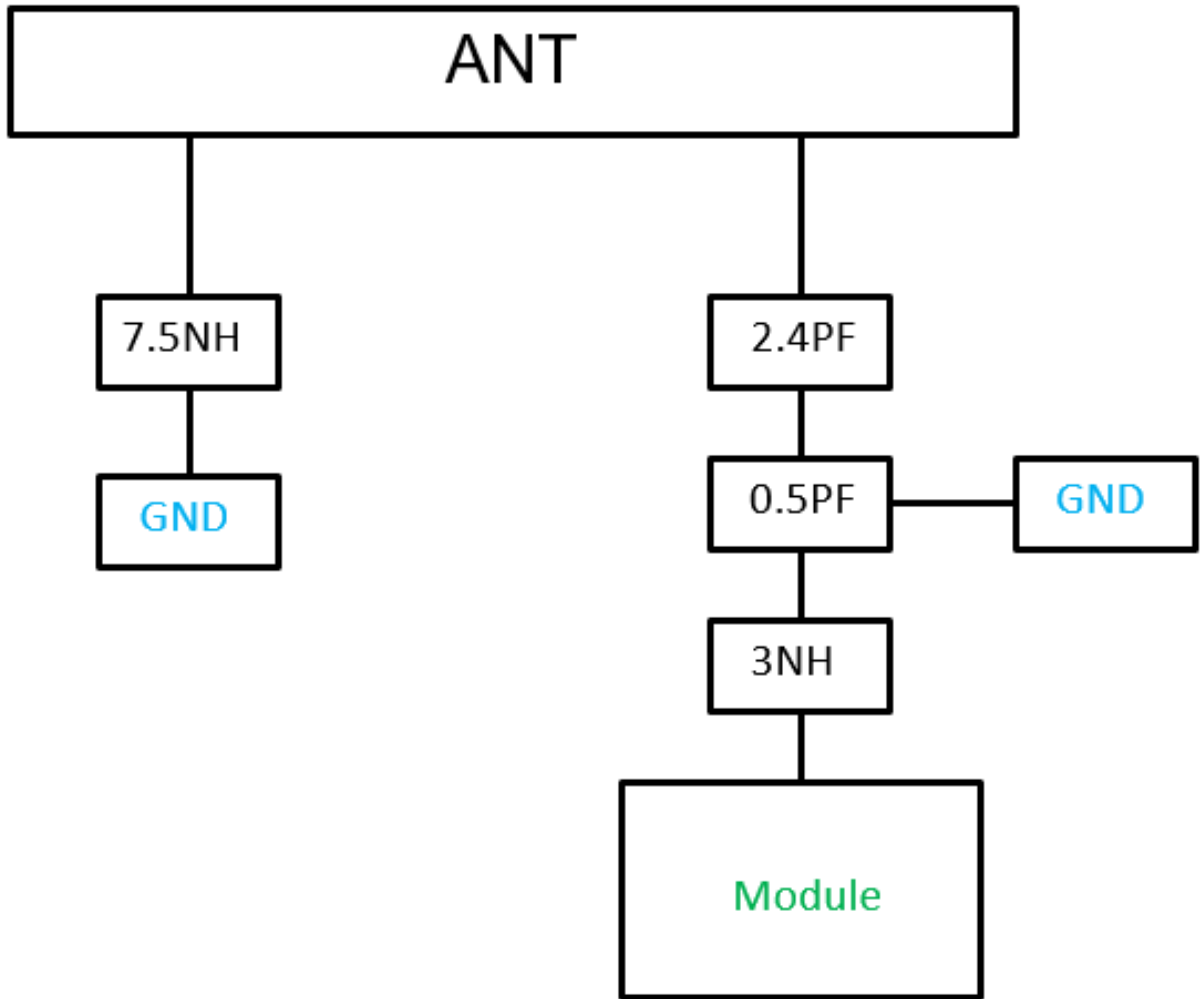

# 8 Soldering Temperature

Phase	Profile Features	PB-Free Assembly
RAMP-UP	Avg. Ramp-up Rate (T <sub>max</sub> to T <sub>p</sub> )	4 °C/second (Max.)
PREHEAT	Temperature Min (T <sub>min</sub> ) Temperature Max (T <sub>max</sub> ) Time (t <sub>min</sub> to t <sub>max</sub> )	150 °C 180 °C 120 seconds (Max.)
REFLOW	Temperature (TL) Total Time above TL (tl)	217 °C 90 seconds (Max.)
PEAK	Temperature (T <sub>p</sub> )	230–250 °C
RAMP-DOWN	Rate	-4 °C/second (Max.)



# 9 Reflow Profile

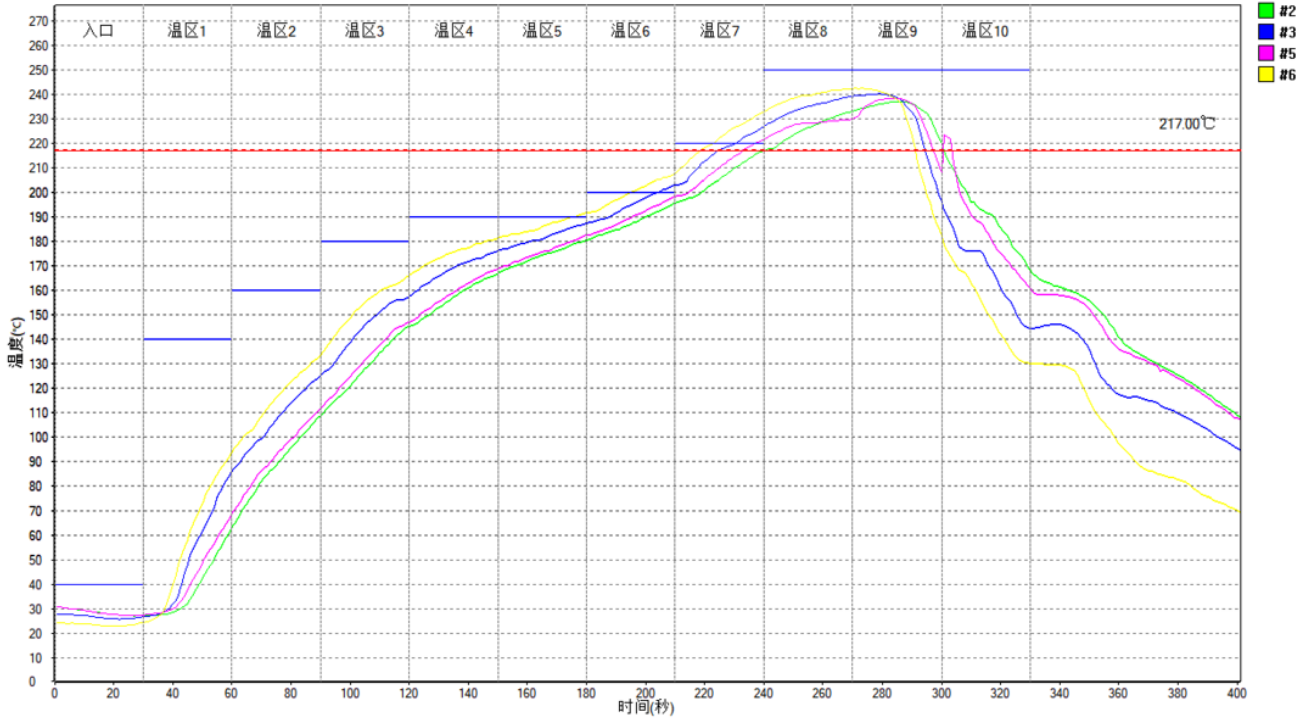

# 10 Packaging

- Quantity/Reel: 1500 pcs/Reel
- Carrier Tape Dimensions (mm)

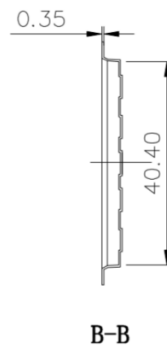
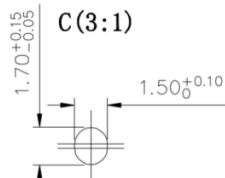
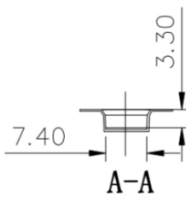
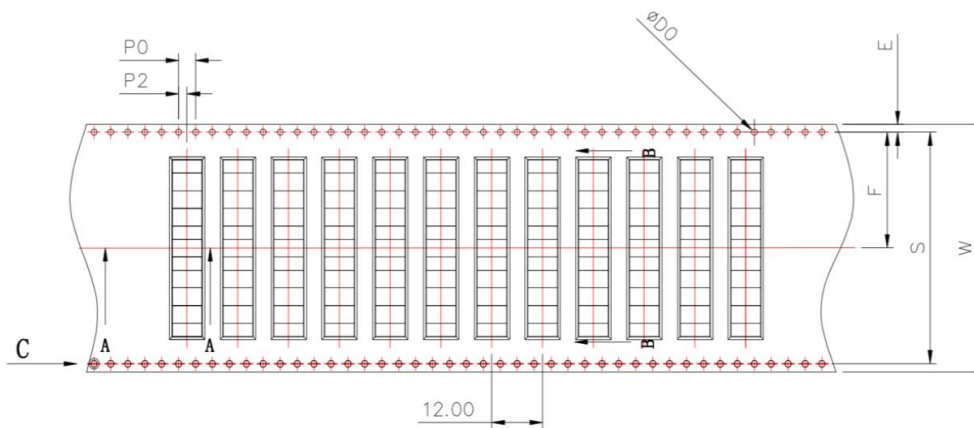

E	1.75±0.10
F	26.20±0.15
S	52.40±0.10
P2	2.00±0.10
φDo	1.50± <sup>0.10</sup> / <sub>0.00</sub>
φD1	
PO	4.00±0.10
10Po	40.00±0.20
W	56.00±0.30

- Taping Reel Dimensions (mm)

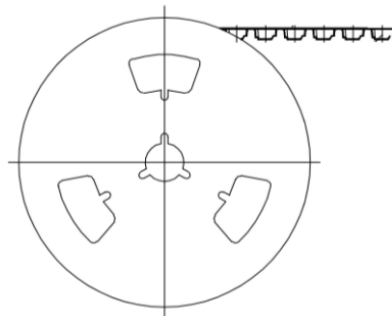

330 mm × 56 mm

## Contact Us

At Quectel, our aim is to provide timely and comprehensive services to our customers. If you require any assistance, please contact our headquarters:

**Quectel Wireless Solutions Co., Ltd.**

Building 5, Shanghai Business Park Phase III (Area B), No.1016 Tianlin Road, Minhang District, Shanghai 200233, China

Tel: +86 21 5108 6236

Email: [info@quectel.com](mailto:info@quectel.com)

**Or our local offices. For more information, please visit:**

<http://www.quectel.com/support/sales.htm>.

**For technical support, or to report documentation errors, please visit:**

<http://www.quectel.com/support/technical.htm>.

Or email us at: [support@quectel.com](mailto:support@quectel.com).

# Legal Notices

We offer information as a service to you. The provided information is based on your requirements and we make every effort to ensure its quality. You agree that you are responsible for using independent analysis and evaluation in designing intended products, and we provide reference designs for illustrative purposes only. Before using any hardware, software or service guided by this document, please read this notice carefully. Even though we employ commercially reasonable efforts to provide the best possible experience, you hereby acknowledge and agree that this document and related services hereunder are provided to you on an “as available” basis. We may revise or restate this document from time to time at our sole discretion without any prior notice to you.

## Use and Disclosure Restrictions

### License Agreements

Documents and information provided by us shall be kept confidential, unless specific permission is granted. They shall not be accessed or used for any purpose except as expressly provided herein.

### Copyright

Our and third-party products hereunder may contain copyrighted material. Such copyrighted material shall not be copied, reproduced, distributed, merged, published, translated, or modified without prior written consent. We and the third party have exclusive rights over copyrighted material. No license shall be granted or conveyed under any patents, copyrights, trademarks, or service mark rights. To avoid ambiguities, purchasing in any form cannot be deemed as granting a license other than the normal non-exclusive, royalty-free license to use the material. We reserve the right to take legal action for noncompliance with abovementioned requirements, unauthorized use, or other illegal or malicious use of the material.

### Trademarks

Except as otherwise set forth herein, nothing in this document shall be construed as conferring any rights to use any trademark, trade name or name, abbreviation, or counterfeit product thereof owned by Quectel or any third party in advertising, publicity, or other aspects.

### Third-Party Rights

This document may refer to hardware, software and/or documentation owned by one or more third parties (“third-party materials”). Use of such third-party materials shall be governed by all restrictions and obligations applicable thereto.

We make no warranty or representation, either express or implied, regarding the third-party materials, including but not limited to any implied or statutory, warranties of merchantability or fitness for a particular purpose, quiet enjoyment, system integration, information accuracy, and non-infringement of any third-party intellectual property rights with regard to the licensed technology or use thereof. Nothing herein constitutes a representation or warranty by us to either develop, enhance, modify, distribute, market, sell, offer for sale, or otherwise maintain production of any our products or any other hardware, software, device, tool, information, or product. We moreover disclaim any and all warranties arising from the course of dealing or usage of trade.

## Privacy Policy

To implement module functionality, certain device data are uploaded to Quectel's or third-party's servers, including carriers, chipset suppliers or customer-designated servers. Quectel, strictly abiding by the relevant laws and regulations, shall retain, use, disclose or otherwise process relevant data for the purpose of performing the service only or as permitted by applicable laws. Before data interaction with third parties, please be informed of their privacy and data security policy.

## Disclaimer

- a) We acknowledge no liability for any injury or damage arising from the reliance upon the information.
- b) We shall bear no liability resulting from any inaccuracies or omissions, or from the use of the information contained herein.
- c) While we have made every effort to ensure that the functions and features under development are free from errors, it is possible that they could contain errors, inaccuracies, and omissions. Unless otherwise provided by valid agreement, we make no warranties of any kind, either implied or express, and exclude all liability for any loss or damage suffered in connection with the use of features and functions under development, to the maximum extent permitted by law, regardless of whether such loss or damage may have been foreseeable.
- d) We are not responsible for the accessibility, safety, accuracy, availability, legality, or completeness of information, advertising, commercial offers, products, services, and materials on third-party websites and third-party resources.

**Copyright © Quectel Wireless Solutions Co., Ltd. 2023. All rights reserved.**

# Revision History

Version	Date	Author	Note
-	2023-01-28	Kane LIU/ Toby WANG	Creation of the document
1.0	2023-01-28	Kane LIU/ Toby WANG	First official release
2.0	2023-02-08	Kane LIU/ Toby WANG/ David LIU/ Vinnie LIU	Updated templates and test data

**QUECTEL**

[www.quectel.com](http://www.quectel.com)