

A photograph of the antenna component is centered in the upper half of the page. It features a gold-colored SMA connector at the top, a black cable, and a black rectangular label with the text "Quectel_YF0027_ANT_X4". The background is a white, textured surface with a repeating pattern of small, raised, diamond-shaped elements.

Quectel_YF0027_ANT_X4

Antenna Datasheet

Product OC: YF0027AA

Version: 2.3

Date: 2025-05-19

Status: Released

Product Name: Wi-Fi Adhesive Mount FPC + Cable PIFA Embedded
Antenna

Key Features:

Frequency band: 2400–2500 MHz, 5150–5850 MHz, 5925–7125 MHz

Peak efficiency: 80.4 % (ABS)

Dimensions: 38 mm × 7 mm

RoHS and REACH Compliant

Overview

The YF0027AA is a Wi-Fi FPC antenna measuring 38 × 7 mm. This Wi-Fi antenna provides coverage from 2400–2500 MHz, 5150–5850 MHz, 5925–7125 MHz. The antenna has a 100 mm-long cable, terminated with IPEX MHF 1 connector, and is available with customized cable lengths and connectors. This adhesive mount omni-directional antenna, ideal for applications where the antenna is required to be mounted inside, is easy to install thanks to its flexible material. It is compatible with Quectel's Wi-Fi Series modules. It has been tested with ABS board.

It allows constant and reliable transmission and reception due to its omni-directional gain across all frequency bands. The YF0027AA is designed as a PIFA antenna, which is to offer high efficiency in many different mounting scenarios. It is a perfect antenna product for customers that desire highest performance. This high-efficiency, high-gain omni-directional antenna is ideally suited for smart metering, remote monitoring, vehicle tracking and telematics, and many other IoT devices.

Quectel provides comprehensive antenna design support such as simulation, testing and manufacturing for custom antenna solutions to meet your specific application needs. We have regional R & D centers to offer quick response to meet your requirements. Please contact our sales & FAEs if you have any requests.

Contents

Overview	1
Contents	2
1 Specification	3
1.1. Electrical.....	3
1.2. Mechanical & Environmental	5
2 Drawing	6
3 Detailed Performance	7
3.1. S-Parameter Test	7
3.1.1. VSWR.....	7
3.1.2. Return Loss	8
3.2. Radiation Performance Test.....	9
3.2.1. Efficiency	9
3.2.2. Average Gain	10
3.2.3. Peak Gain.....	11
3.2.4. 3D & 2D Radiation Pattern.....	12
3.2.4.1. Test Condition: Free Space	12
3.2.4.2. Test Condition: Stick on 2 mm Thick ABS Board	14
4 Packaging	16
Contact Us	18
Legal Notices	19
Revision History	21

1 Specification

Test Condition: Free Space & Stick on 2 mm Thick ABS Board

1.1. Electrical

Electrical	
Frequency Range	2400–2500 MHz, 5150–5850 MHz, 5925–7125 MHz
Impedance	50 Ω
Polarization	Linear
Radiation Pattern	Omni-directional

Specification	Band	Band	Wi-Fi 2G	Wi-Fi 5G	Wi-Fi 6G
		Freq. (MHz)	2400–2500	5150–5850	5925–7125
Max. VSWR	FS		6.6	3.0	1.9
	ABS		1.6	1.7	2.5
Max. Return Loss (dB)	FS		-2.6	-6.1	-10.3
	ABS		-13.3	-11.3	-7.5
AVG Eff. (%)	FS		25.7	56.5	65.2
	ABS		80.4	67.4	60.9
AVG. AVG Gain (dB)	FS		-5.9	-6.4	-1.9
	ABS		-0.9	-1.1	-2.2
Max. Peak Gain (dBi)	FS		-1.2	-2.2	3.6
	ABS		2.7	2.0	6.4
VSWR	FS		≤ 6.6		

	ABS	≤ 1.7
Return Loss	FS	≤ -2.6 dB
	ABS	≤ -7.5 dB
Peak Gain	FS	≤ 3.6 dBi
	ABS	≤ 6.4 dBi

- **FS: Free Space**
- **ABS: Stick on 2 mm Thick ABS Board**

1.2. Mechanical & Environmental

Mechanical	
Antenna Size	38 mm × 7 mm
Antenna Material & Color	FPC & Black
Cable Type & Color & Length	Φ 1.37 & Black & 100 mm
Connector Type	IPEX MHF 1
Mounting Type	Adhesive
Antenna Weight	Typ. 0.6 g
Environmental	
Operation Temperature	-40 °C to +85 °C
Storage Temperature	-40 °C to +85 °C
RoHS and REACH Compliant	Yes

2 Drawing

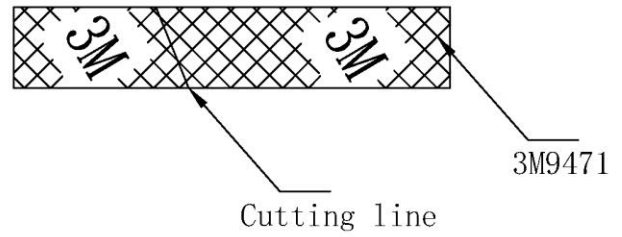
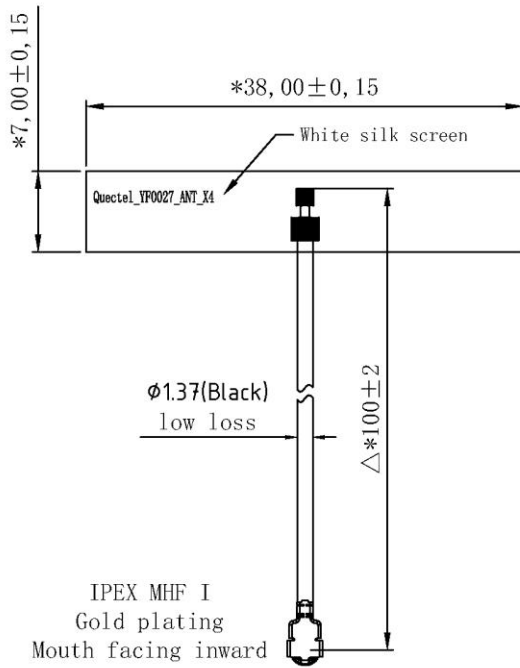

3 Detailed Performance

3.1. S-Parameter Test

3.1.1. VSWR

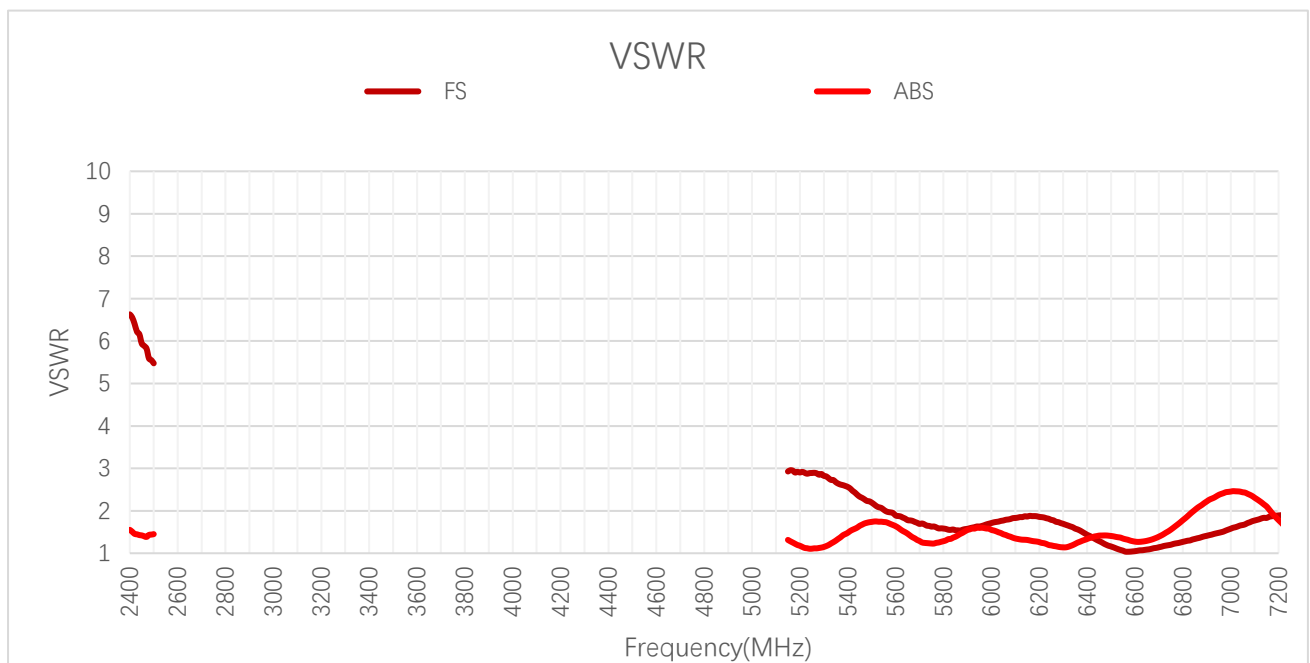

VSWR

Frequency (MHz)	2400	2450	2500	5150	5500	5850	5920	6320	6720	7120
FS	6.6	5.9	5.5	2.9	2.2	1.5	1.6	1.7	1.2	1.8
ABS	1.6	1.4	1.4	1.3	1.7	1.4	1.6	1.2	1.5	2.2

3.1.2. Return Loss

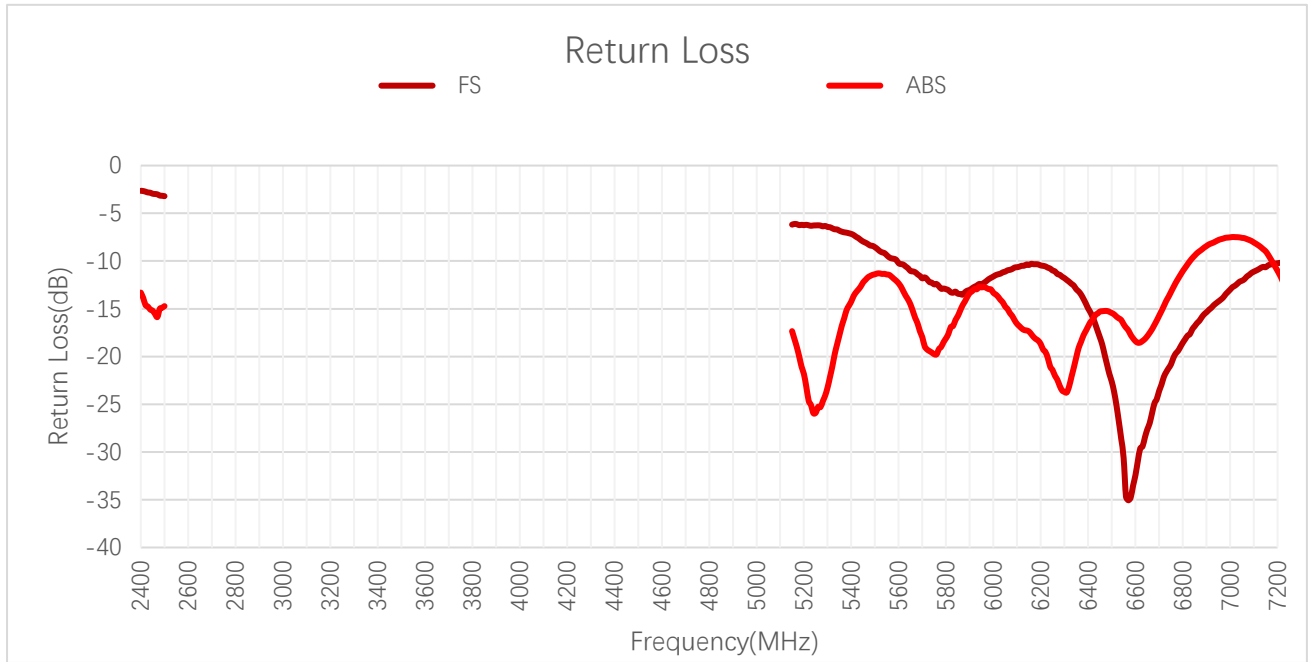

Return Loss

Frequency (MHz)	2400	2450	2500	5150	5500	5850	5920	6320	6720	7120
FS	-2.6	-3.0	-3.2	-6.2	-8.6	-13.4	-12.7	-12.2	-22.1	-10.9
ABS	-13.3	-15.2	-14.7	-17.3	-11.4	-15.8	-12.9	-23.1	-14.7	-8.4

3.2. Radiation Performance Test

3.2.1. Efficiency

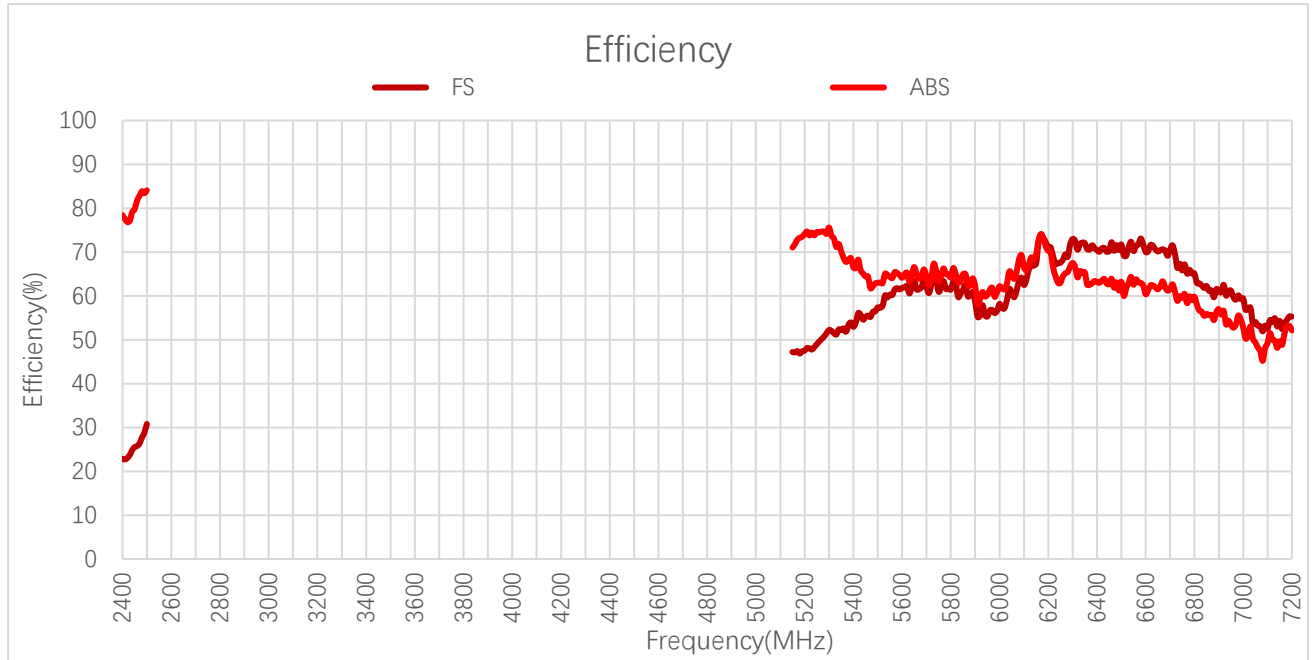

Efficiency (%)

Frequency (MHz)	2400	2450	2500	5150	5500	5850	5920	6320	6720	7120
FS	22.8	25.5	30.8	47.2	57.4	61.4	55.5	70.5	69.6	54.0
ABS	78.4	79.8	84.1	71.0	63.0	64.9	59.3	64.2	60.9	50.0

3.2.2. Average Gain

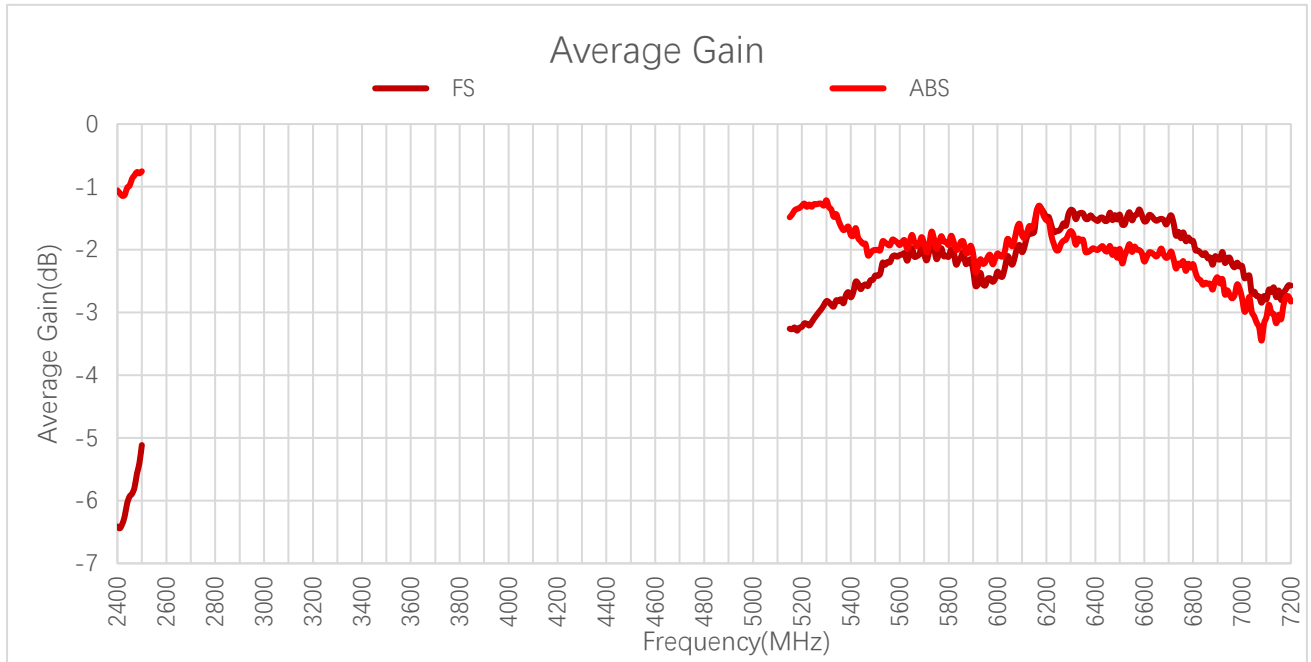

Average Gain (dB)

Frequency (MHz)	2400	2450	2500	5150	5500	5850	5920	6320	6720	7120
FS	-6.4	-5.9	-5.1	-3.3	-2.4	-2.1	-2.6	-1.5	-1.6	-2.7
ABS	-1.1	-1.0	-0.8	-1.5	-2.0	-1.9	-2.3	-1.9	-2.2	-3.0

3.2.3. Peak Gain

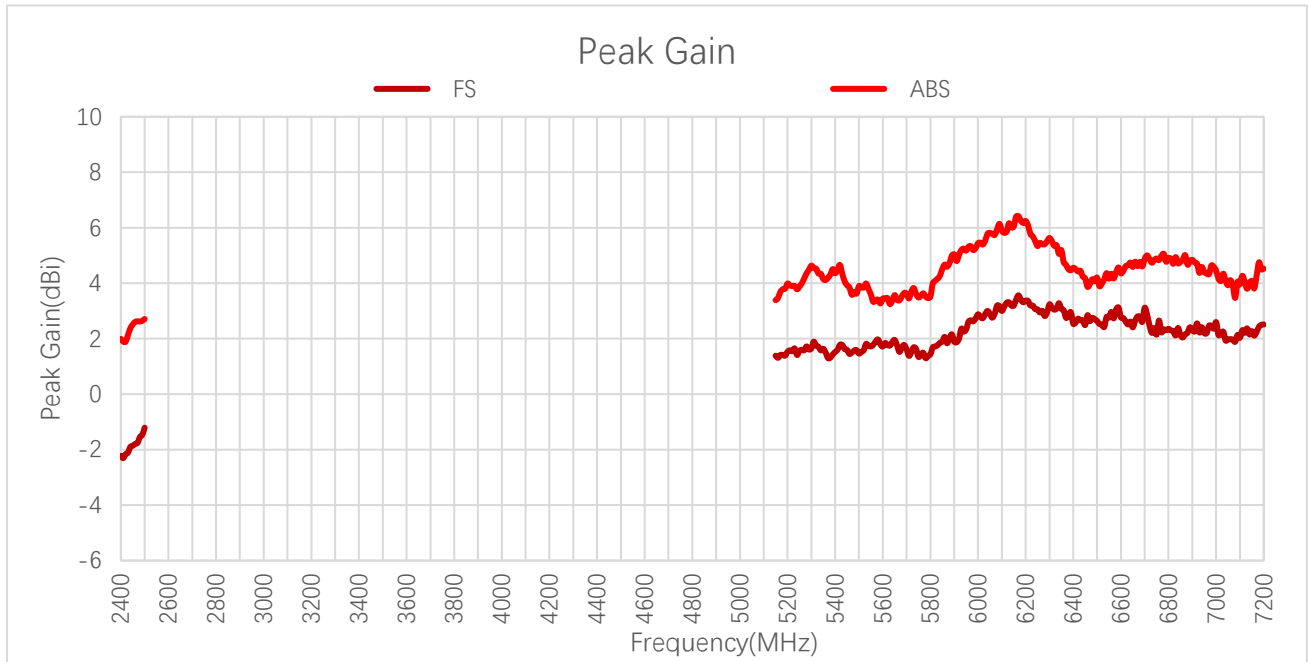

Peak Gain (dBi)

Frequency (MHz)	2400	2450	2500	5150	5500	5850	5920	6320	6720	7120
FS	-2.2	-1.9	-1.2	1.4	1.5	1.9	2.0	3.0	2.5	2.2
ABS	2.0	2.5	2.7	3.4	3.9	4.5	5.0	5.3	4.9	4.0

3.2.4. 3D & 2D Radiation Pattern

3.2.4.1. Test Condition: Free Space

- Test Chamber: HF-G-1

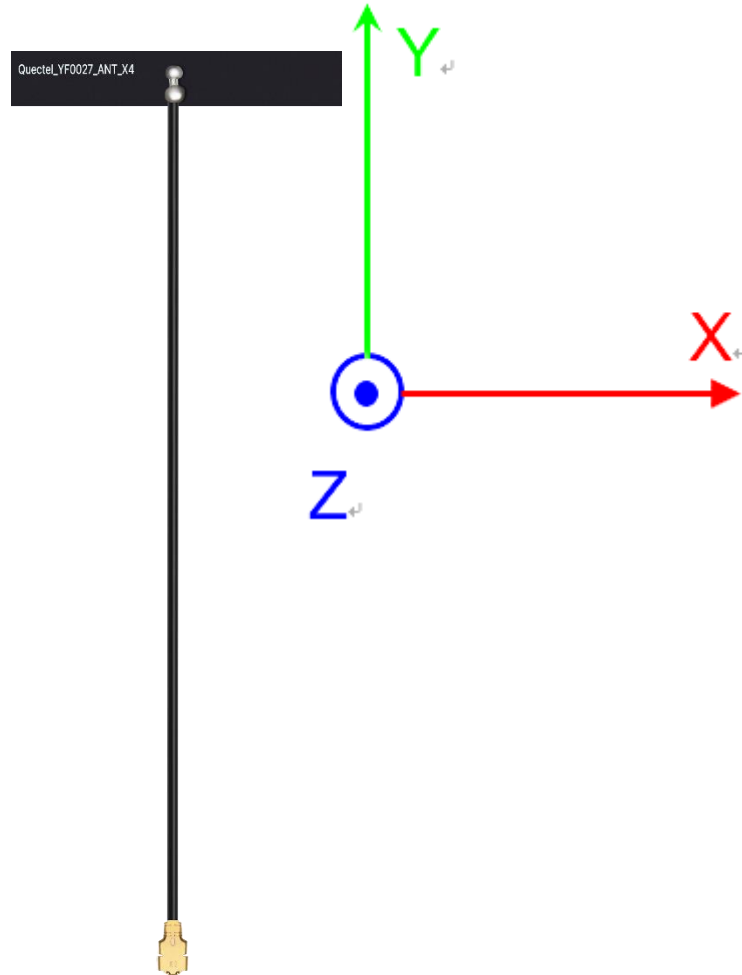

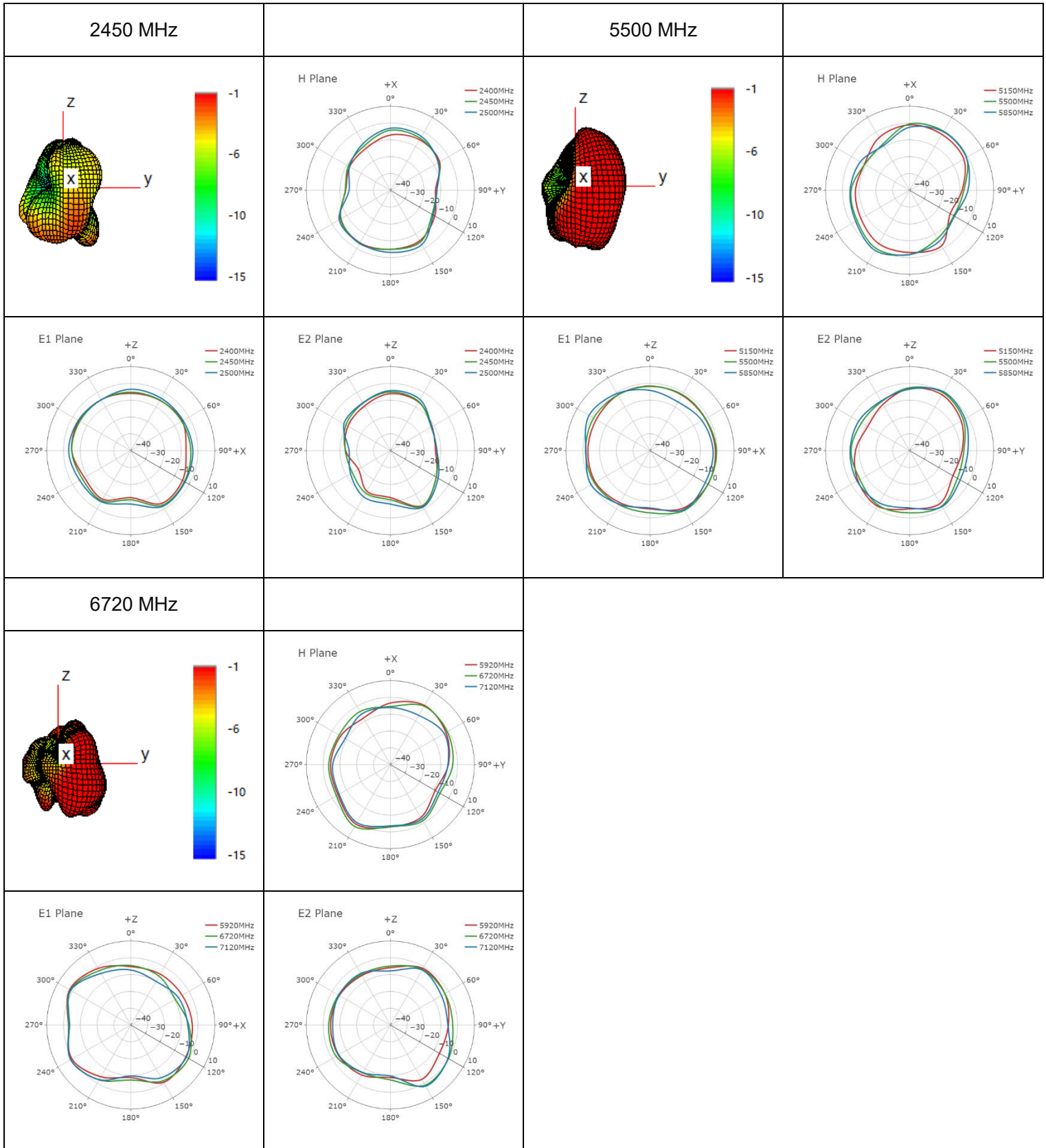



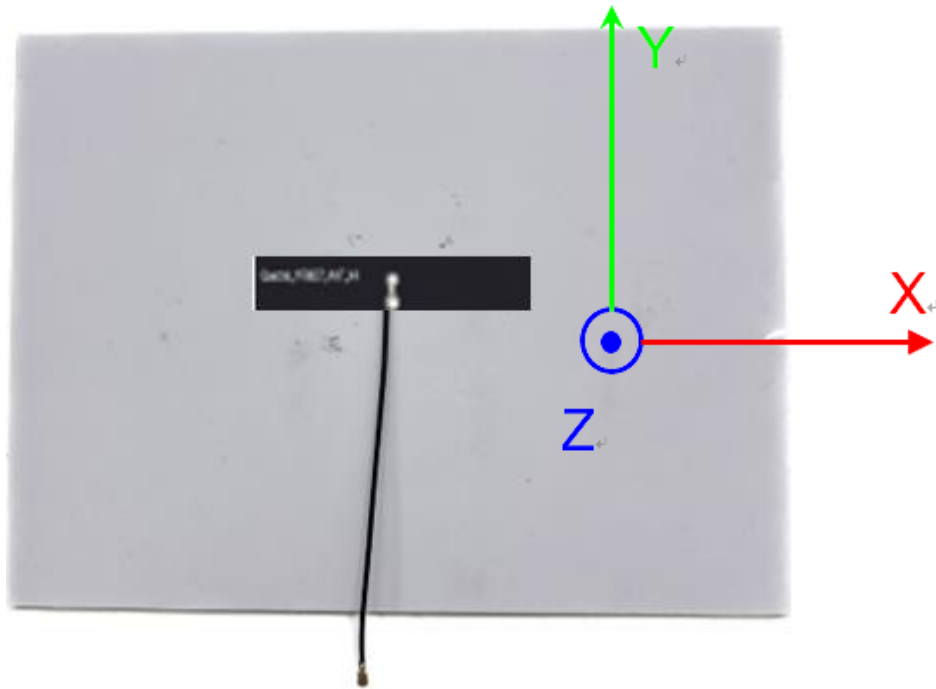

3.2.4.2. Test Condition: Stick on 2 mm Thick ABS Board

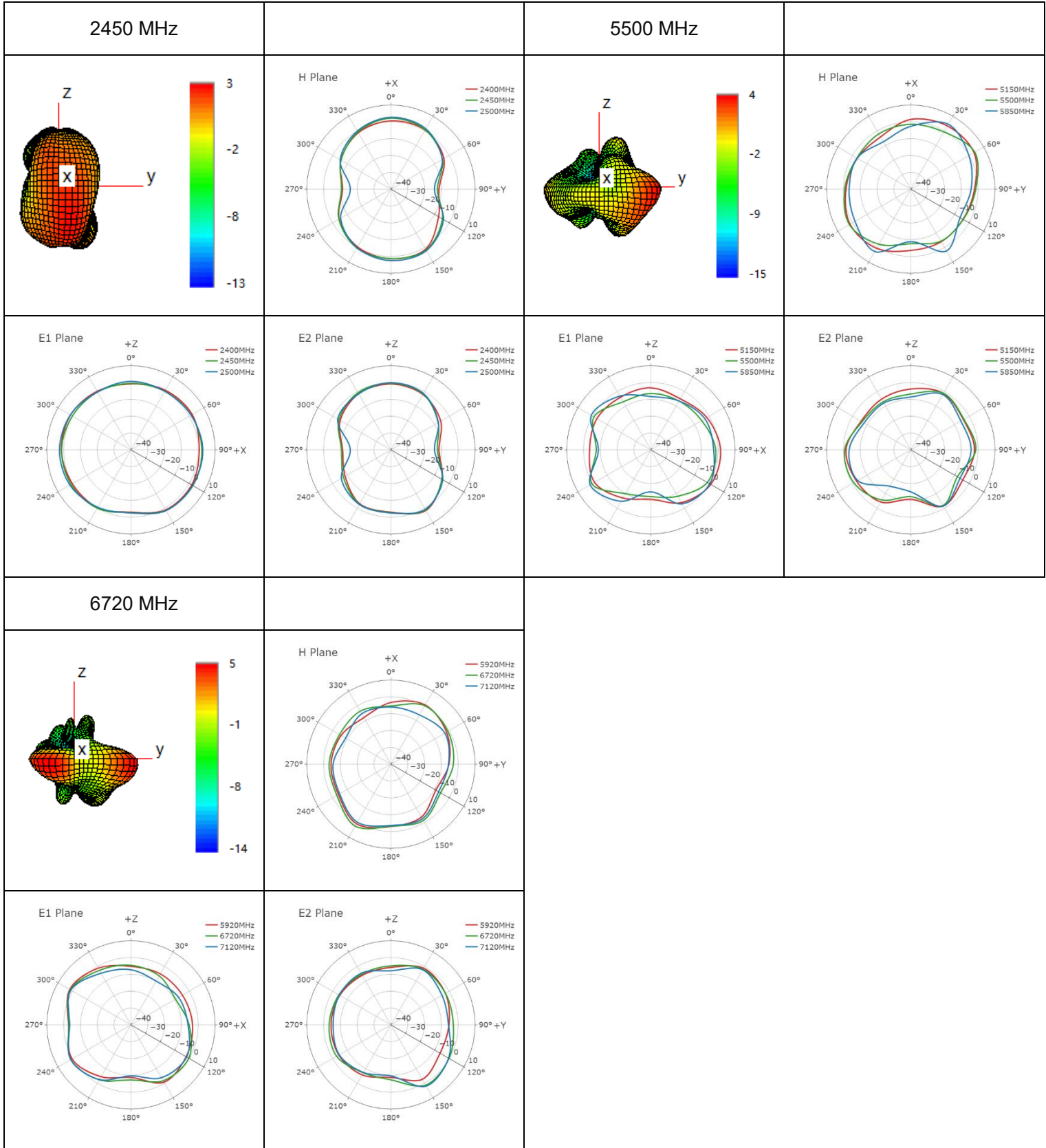
- Test Chamber: HF-G-1



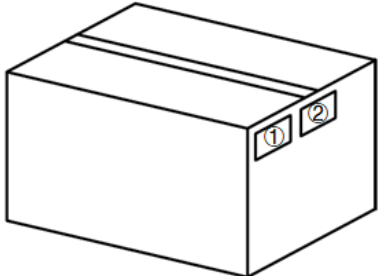

4 Packaging

Step	Packaging Picture / 2D Picture	Description
1		<p>50 pcs antenna products are wrapped with EPE foam. (50 PCS Antennas / Tie)</p>
2		<p>200 pcs antenna products in a PE bag. (200 PCS Antennas / PE Bag)</p>
3		<p>(25 PE Bags / Carton Box) (5000 PCS Antennas / Carton Box) Estimated quantity Products that cannot fill the entire carton box are packed in a suitable size carton box. <u>Carton Size:</u> <u>L x W x H = 275 x 275 x 185 mm</u></p>
4		<p>Position for Attaching Labels</p> <ul style="list-style-type: none"> ① Carton Label ② Quality Label

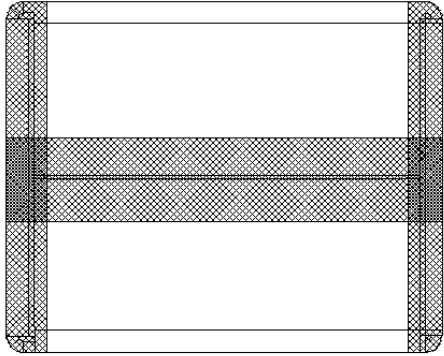
5	 A technical drawing of an H-shaped sealing carton. It consists of two vertical rectangular strips on the left and right sides, connected by two horizontal strips in the middle, forming an 'H' shape. The strips are shaded with a cross-hatch pattern to indicate they are made of a textured material like mesh or fabric.	Sealing Cartons H-shaped sealing cartons
Note	The initial packaging method described above is for reference only, and the final actual packaging method shall be subject to the actual shipping packaging.	

Contact Us

At Quectel, our aim is to provide timely and comprehensive services to our customers. If you require any assistance, please contact our headquarters:

Quectel Wireless Solutions Co., Ltd.

Building 5, Shanghai Business Park Phase III (Area B), No.1016 Tianlin Road, Minhang District, Shanghai 200233, China

Tel: +86 21 5108 6236

Email: info@quectel.com

Or our local offices. For more information, please visit:

<http://www.quectel.com/support/sales.htm>.

For technical support, or to report documentation errors, please visit:

<http://www.quectel.com/support/technical.htm>.

Or email us at: support@quectel.com.

Legal Notices

We offer information as a service to you. The provided information is based on your requirements and we make every effort to ensure its quality. You agree that you are responsible for using independent analysis and evaluation in designing intended products, and we provide reference designs for illustrative purposes only. Before using any hardware, software or service guided by this document, please read this notice carefully. Even though we employ commercially reasonable efforts to provide the best possible experience, you hereby acknowledge and agree that this document and related services hereunder are provided to you on an “as available” basis. We may revise or restate this document from time to time at our sole discretion without any prior notice to you.

Use and Disclosure Restrictions

License Agreements

Documents and information provided by us shall be kept confidential, unless specific permission is granted. They shall not be accessed or used for any purpose except as expressly provided herein.

Copyright

Our and third-party products hereunder may contain copyrighted material. Such copyrighted material shall not be copied, reproduced, distributed, merged, published, translated, or modified without prior written consent. We and the third party have exclusive rights over copyrighted material. No license shall be granted or conveyed under any patents, copyrights, trademarks, or service mark rights. To avoid ambiguities, purchasing in any form cannot be deemed as granting a license other than the normal non-exclusive, royalty-free license to use the material. We reserve the right to take legal action for noncompliance with abovementioned requirements, unauthorized use, or other illegal or malicious use of the material.

Trademarks

Except as otherwise set forth herein, nothing in this document shall be construed as conferring any rights to use any trademark, trade name or name, abbreviation, or counterfeit product thereof owned by Quectel or any third party in advertising, publicity, or other aspects.

Third-Party Rights

This document may refer to hardware, software and/or documentation owned by one or more third parties (“third-party materials”). Use of such third-party materials shall be governed by all restrictions and obligations applicable thereto.

We make no warranty or representation, either express or implied, regarding the third-party materials, including but not limited to any implied or statutory, warranties of merchantability or fitness for a particular purpose, quiet enjoyment, system integration, information accuracy, and non-infringement of any third-party intellectual property rights with regard to the licensed technology or use thereof. Nothing herein constitutes a representation or warranty by us to either develop, enhance, modify, distribute, market, sell, offer for sale, or otherwise maintain production of any our products or any other hardware, software, device, tool, information, or product. We moreover disclaim any and all warranties arising from the course of dealing or usage of trade.

Privacy Policy

To implement module functionality, certain device data are uploaded to Quectel's or third-party's servers, including carriers, chipset suppliers or customer-designated servers. Quectel, strictly abiding by the relevant laws and regulations, shall retain, use, disclose or otherwise process relevant data for the purpose of performing the service only or as permitted by applicable laws. Before data interaction with third parties, please be informed of their privacy and data security policy.

Disclaimer

- a) We acknowledge no liability for any injury or damage arising from the reliance upon the information.
- b) We shall bear no liability resulting from any inaccuracies or omissions, or from the use of the information contained herein.
- c) While we have made every effort to ensure that the functions and features under development are free from errors, it is possible that they could contain errors, inaccuracies, and omissions. Unless otherwise provided by valid agreement, we make no warranties of any kind, either implied or express, and exclude all liability for any loss or damage suffered in connection with the use of features and functions under development, to the maximum extent permitted by law, regardless of whether such loss or damage may have been foreseeable.
- d) We are not responsible for the accessibility, safety, accuracy, availability, legality, or completeness of information, advertising, commercial offers, products, services, and materials on third-party websites and third-party resources.

Copyright © Quectel Wireless Solutions Co., Ltd. 2025. All rights reserved.

Revision History

Version	Date	Author	Note
-	2021-04-01	Kenny YIN	Creation of the document
1.0	2021-04-01	Kenny YIN	First official release
1.1	2021-11-30	Kenny YIN	Updated the product description (Chapter 1).
2.0	2023-04-27	Aria CHU/ Lucky FENG/ David LIU	Updated all data and datasheet template.
2.1	2023-12-05	Lucky FENG/ Aria CHU	Added REACH compliant (Chapter 1.2).
2.2	2024-06-26	Bailey ZHANG	Updated the drawing (Chapter 2).
2.3	2025-05-19	Riva REN/ Aria CHU	<ol style="list-style-type: none">1. Updated the antenna image (Cover page).2. Updated the overview.3. Updated the packaging (Chapter 4).

QUECTEL

www.quectel.com