



# Antenna Datasheet

**Product OC:** YEBT002W1BM

**Version:** 1.0

**Date:** 2025-05-19

**Status:** Released

**Product Name:** Wi-Fi Terminal Mount Rubber Monopole External Antenna

**Key Features:**

Frequency Band: 2400–2500 MHz, 5150–5850 MHz, 5925–7125 MHz

Dimensions: 135 mm × 15.6 mm × 13 mm

Efficiency: Up to 72.4 %

RoHS Compliant

Compatible with FAKRA, TNC and N-Type connectors

# Overview

YEBT002W1BM is a Wi-Fi external antenna measuring 135 mm × 15.6 mm × 13 mm. This ultra-wide-band Wi-Fi antenna provides broad coverage from 2400–2500 MHz & 5150–5850 MHz & 5925–7125 MHz. The antenna is terminated with SMA Male connector, also supports N male, TNC male, Fakra male connectors. Ideal for applications where the antenna is required to be discrete, this low profile, terminal mount omnidirectional antenna is easy to install with maximum durability assured thanks to its PC+ABS enclosure. It is compatible with Quectel's Wi-Fi modules.

The antenna is designed as dipole type to work with various GND plane sizes or in free space for ease of integration with a hinged SMA Male connector to achieve the optimum position. Hinged structure helps to avoid other antennas or objects by rotating to different directions when mounted on terminals. This omnidirectional antenna is ideally suited for Wi-Fi, WLAN, Zigbee, Bluetooth, and 802.11a/b/g/n/ac applications, WIFI application points and routers, offering great performance with its high gain and efficiency.

Typical applications include:

- Wi-Fi, WLAN, Zigbee, Bluetooth, and 802.11a/b/g/n/ac applications
- Wi-Fi application points and routers

Quectel provides comprehensive antenna design support such as simulation, testing and manufacturing for custom antenna solutions to meet your specific application needs. We have regional R & D centers to offer quick response to meet your requirements. Please contact our sales & FAEs if you have any requests.

# Contents

Overview.....	1
Contents.....	2
<b>1 Specification.....</b>	<b>3</b>
1.1. Electrical.....	3
1.2. Mechanical & Environmental .....	4
<b>2 Drawing .....</b>	<b>5</b>
<b>3 Detailed Performance.....</b>	<b>6</b>
3.1. S-Parameter Test .....	6
3.1.1. VSWR .....	6
3.1.2. Return Loss.....	7
3.2. Radiation Performance Test.....	8
3.2.1. Efficiency.....	8
3.2.2. Average Gain .....	9
3.2.3. Peak Gain .....	10
3.2.4. 3D & 2D Radiation Pattern .....	11
3.2.4.1. Test Condition: Free Space .....	11
3.2.4.2. Test Condition: On 130 mm × 70 mm EVB .....	13
<b>4 Packaging .....</b>	<b>15</b>
<b>Contact Us.....</b>	<b>17</b>
<b>Legal Notices .....</b>	<b>18</b>
<b>Revision History .....</b>	<b>20</b>

# 1 Specification

Test Condition: Free Space & 130 mm × 70 mm EVB

## 1.1. Electrical

Electrical	
Frequency Range	2400–2500 MHz, 5150–5850 MHz, 5925–7125 MHz
Impedance	50 Ω
Polarization	Linear
Radiation Pattern	Omni-directional

Specification	Band	Band	Wi-Fi 2G	Wi-Fi 5G	Wi-Fi 6G
		Freq. (MHz)	2400–2500	5150–5850	5925–7125
Max. VSWR	FS		1.9	2.1	1.7
	EVB		1.9	1.8	2.5
Max. Return Loss (dB)	FS		-10.0	-9.1	-11.9
	EVB		-10.0	-11.0	-7.3
AVG Eff. (%)	FS		51.5	53.7	51.8
	EVB		66.3	60.0	46.4
AVG. AVG Gain (dB)	FS		-2.9	-2.7	-2.9
	EVB		-1.8	-2.3	-3.4
Max. Peak Gain (dBi)	FS		2.1	4.4	4.8
	EVB		3.3	3.9	3.7
VSWR	FS		≤ 2.1		

	<b>EVB</b>	≤ 2.5
<b>Return Loss</b>	<b>FS</b>	≤ -9.1 dB
	<b>EVB</b>	≤ -7.3 dB
<b>Peak Gain</b>	<b>FS</b>	≤ 4.8 dBi
	<b>EVB</b>	≤ 3.9 dBi

- FS: Free Space.
- EVB: On 130 mm × 70 mm EVB.

## 1.2. Mechanical & Environmental

Mechanical	
<b>Antenna Dimensions</b>	135 mm × 15.6 mm × 13 mm
<b>Material &amp; Color</b>	PC + ABS & Black
<b>Connector Type</b>	SMA Male
<b>Mounting Type</b>	Terminal
<b>Weight</b>	Typ. 16 g
Environmental	
<b>Operation Temperature</b>	-40 °C to +85 °C
<b>Storage Temperature</b>	-40 °C to +85 °C
<b>RoHS Compliant</b>	Yes

# 2 Drawing

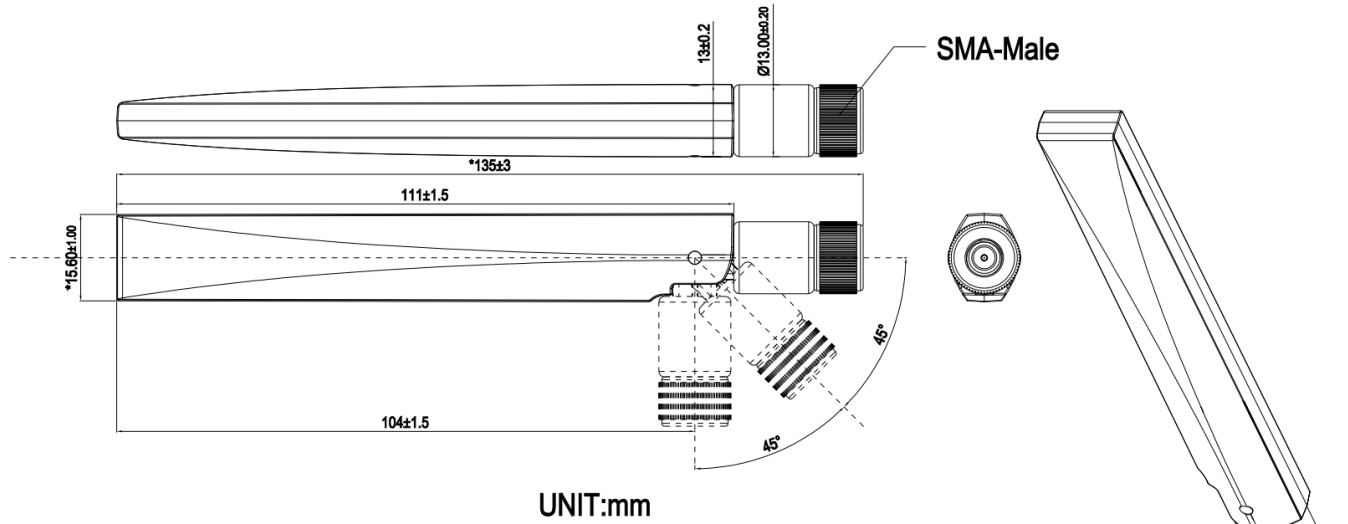

Note: If you use a torque wrench, the recommended force for mounting the antenna is 0.9Nm and the maximum torque to prevent antenna damage is 1.17Nm.

# 3 Detailed Performance

## 3.1. S-Parameter Test

### 3.1.1. VSWR

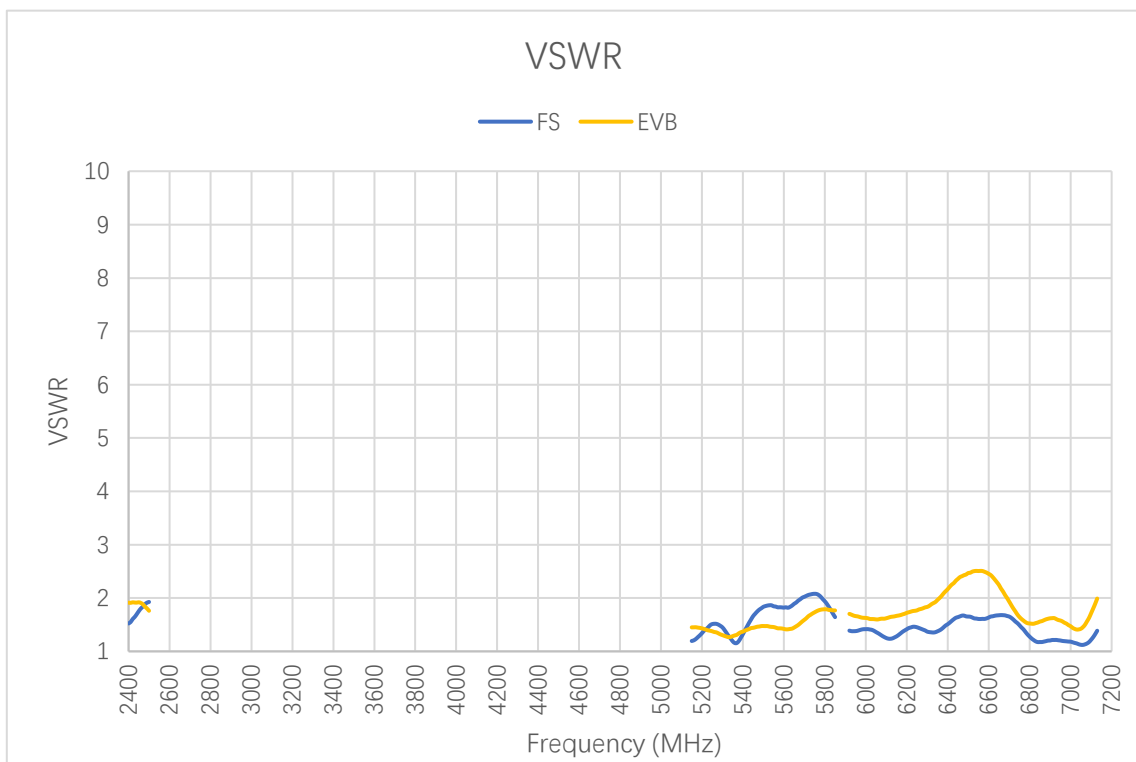

**VSWR**

Frequency (MHz)	2400	2450	2500	5150	5500	5850	5925	6325	6725	7125
<b>FS</b>	1.5	1.8	1.9	1.2	1.8	1.6	1.4	1.4	1.6	1.3
<b>EVB</b>	1.9	1.9	1.8	1.5	1.5	1.8	1.7	1.9	1.8	1.9

**3.1.2. Return Loss**

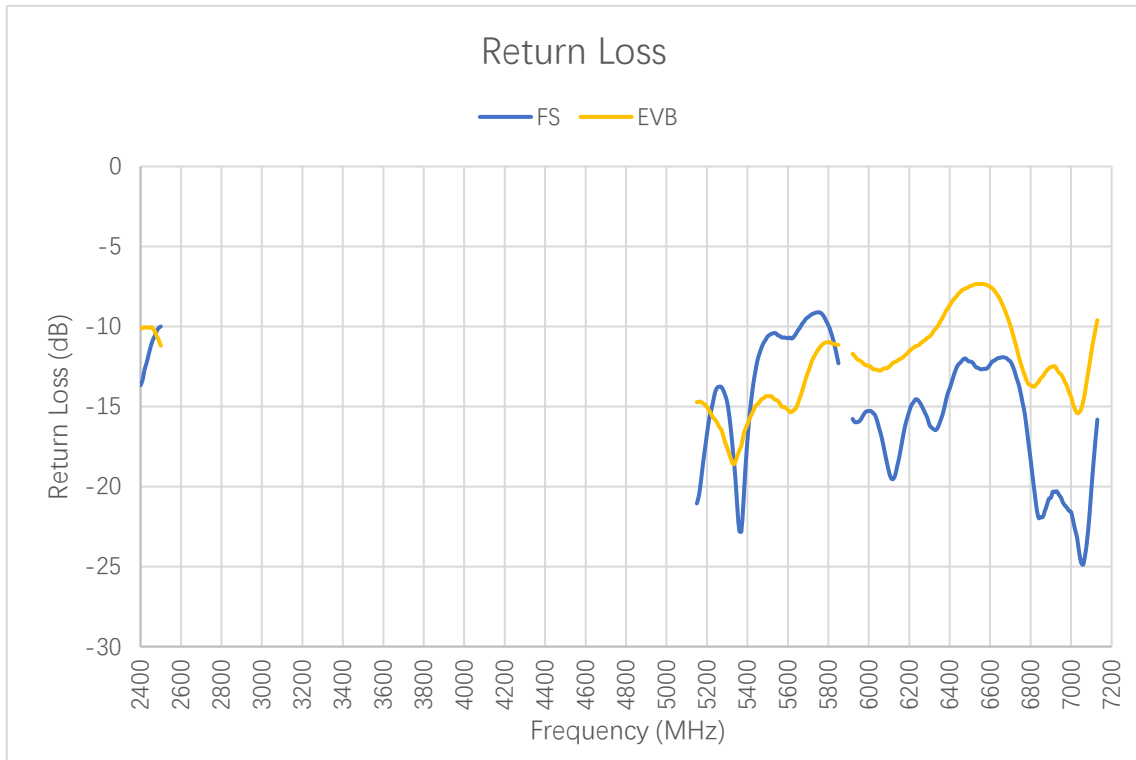

**Return Loss (dB)**

Frequency (MHz)	2400	2450	2500	5150	5500	5850	5925	6325	6725	7125
<b>FS</b>	-13.7	-11.3	-10.0	-21.1	-10.6	-12.3	-15.8	-16.4	-12.8	-17.2
<b>EVB</b>	-10.1	-10.0	-11.2	-14.7	-14.3	-11.1	-11.7	-10.3	-10.8	-10.2

### 3.2. Radiation Performance Test

#### 3.2.1. Efficiency

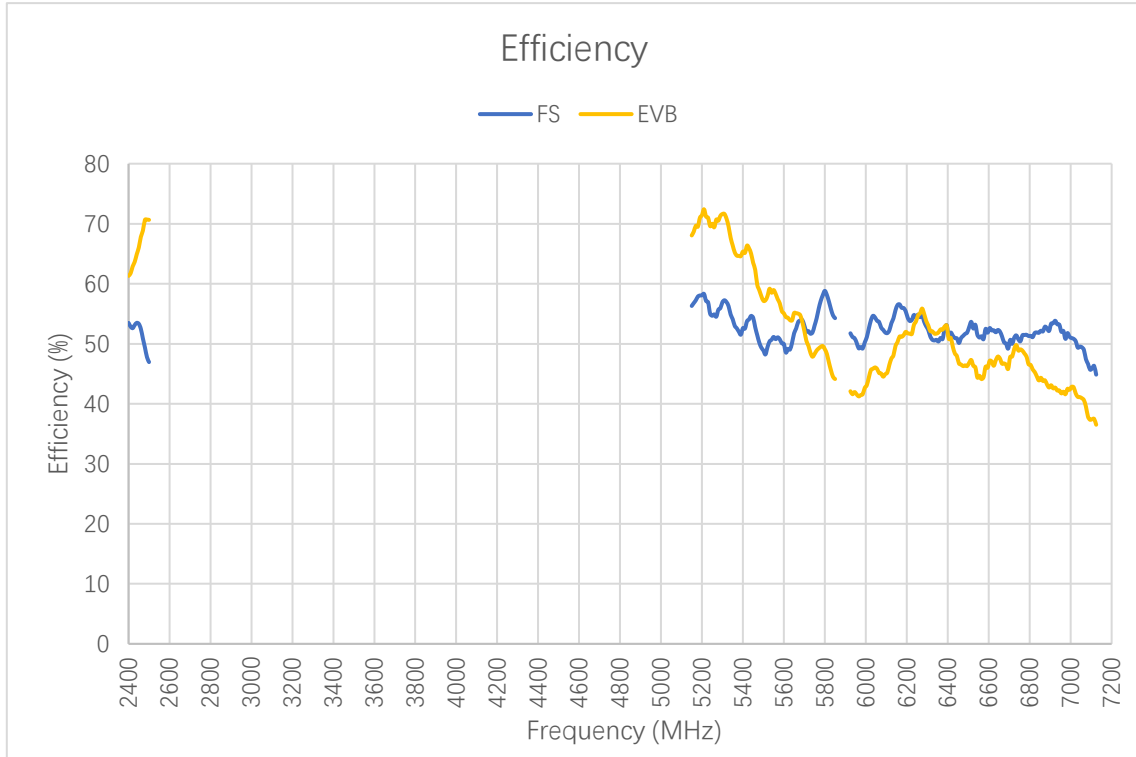

**Efficiency (%)**

Frequency (MHz)	2400	2450	2500	5150	5500	5850	5925	6325	6725	7125
<b>FS</b>	53.5	53.3	47.0	56.3	48.9	54.3	51.8	50.7	51.0	44.9
<b>EVB</b>	61.3	66.1	70.7	68.1	57.2	44.1	42.1	52.1	49.2	36.5

**3.2.2. Average Gain**

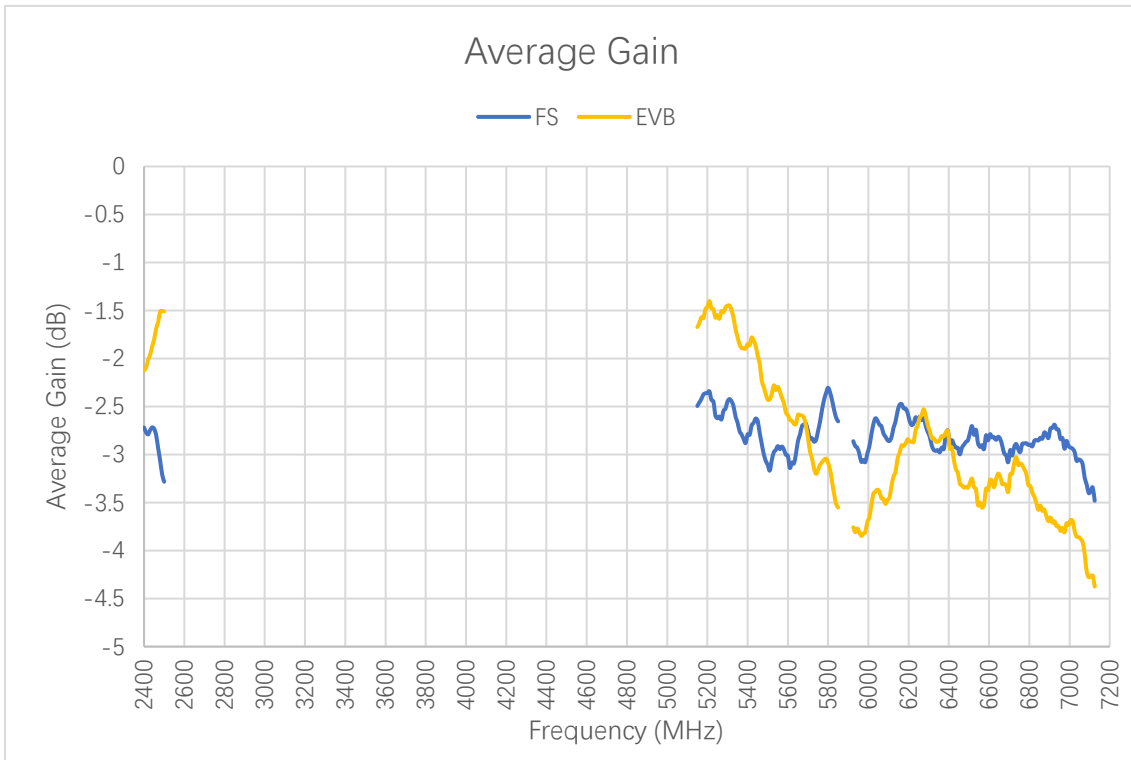

**Average Gain (dB)**

Frequency (MHz)	2400	2450	2500	5150	5500	5850	5925	6325	6725	7125
<b>FS</b>	-2.7	-2.7	-3.3	-2.5	-3.1	-2.7	-2.9	-3.0	-2.9	-3.5
<b>EVB</b>	-2.1	-1.8	-1.5	-1.7	-2.4	-3.6	-3.8	-2.8	-3.1	-4.4

**3.2.3. Peak Gain**

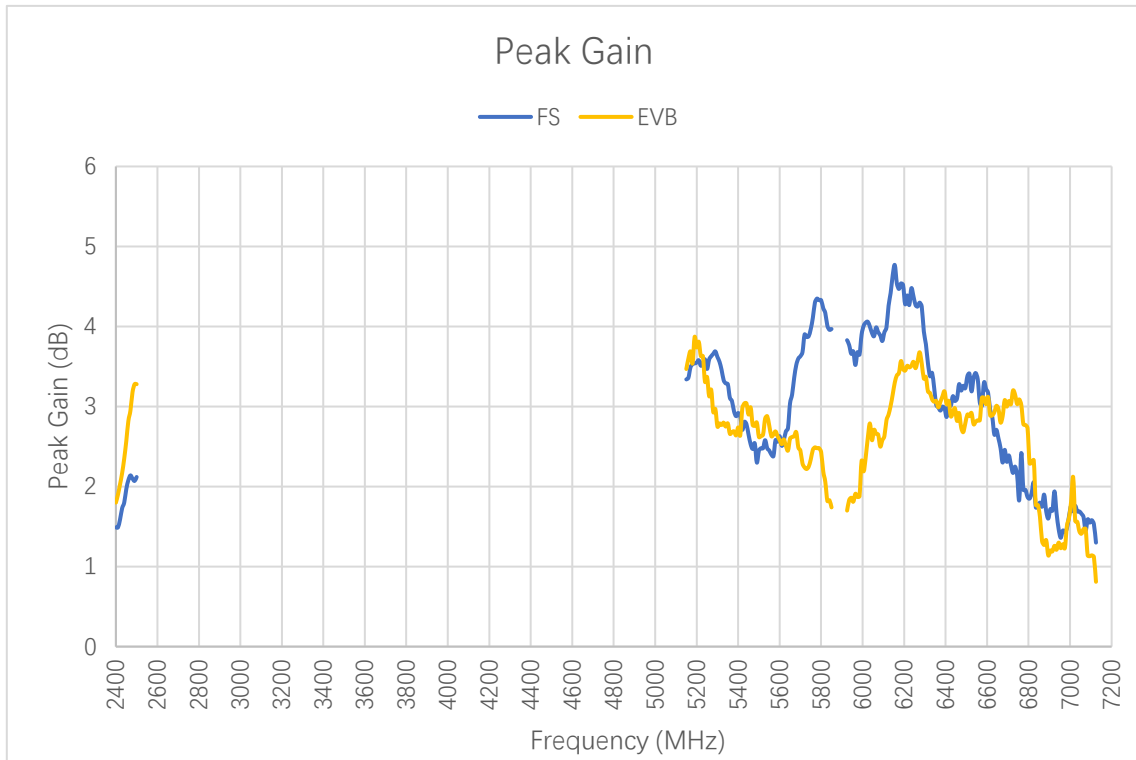

**Peak Gain (dBi)**

Frequency (MHz)	2400	2450	2500	5150	5500	5850	5925	6325	6725	7125
<b>FS</b>	1.5	2.0	2.1	3.3	2.5	4.0	3.8	3.4	2.2	1.3
<b>EVB</b>	1.8	2.6	3.3	3.5	2.6	1.7	1.7	3.2	3.2	0.8

### 3.2.4. 3D & 2D Radiation Pattern

#### 3.2.4.1. Test Condition: Free Space

- Test Chamber: FS-G-1

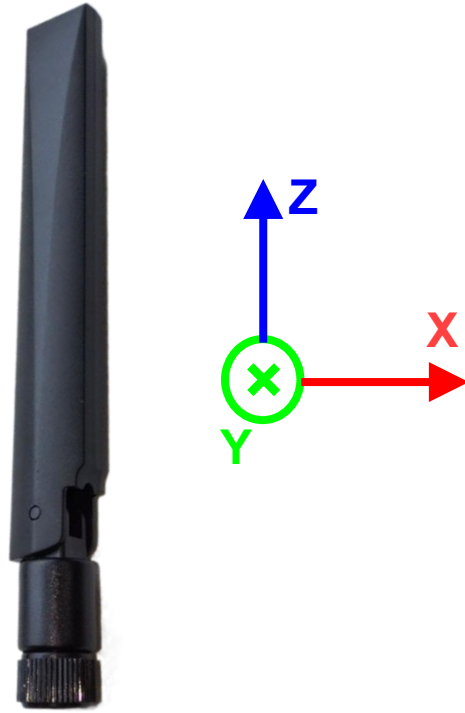

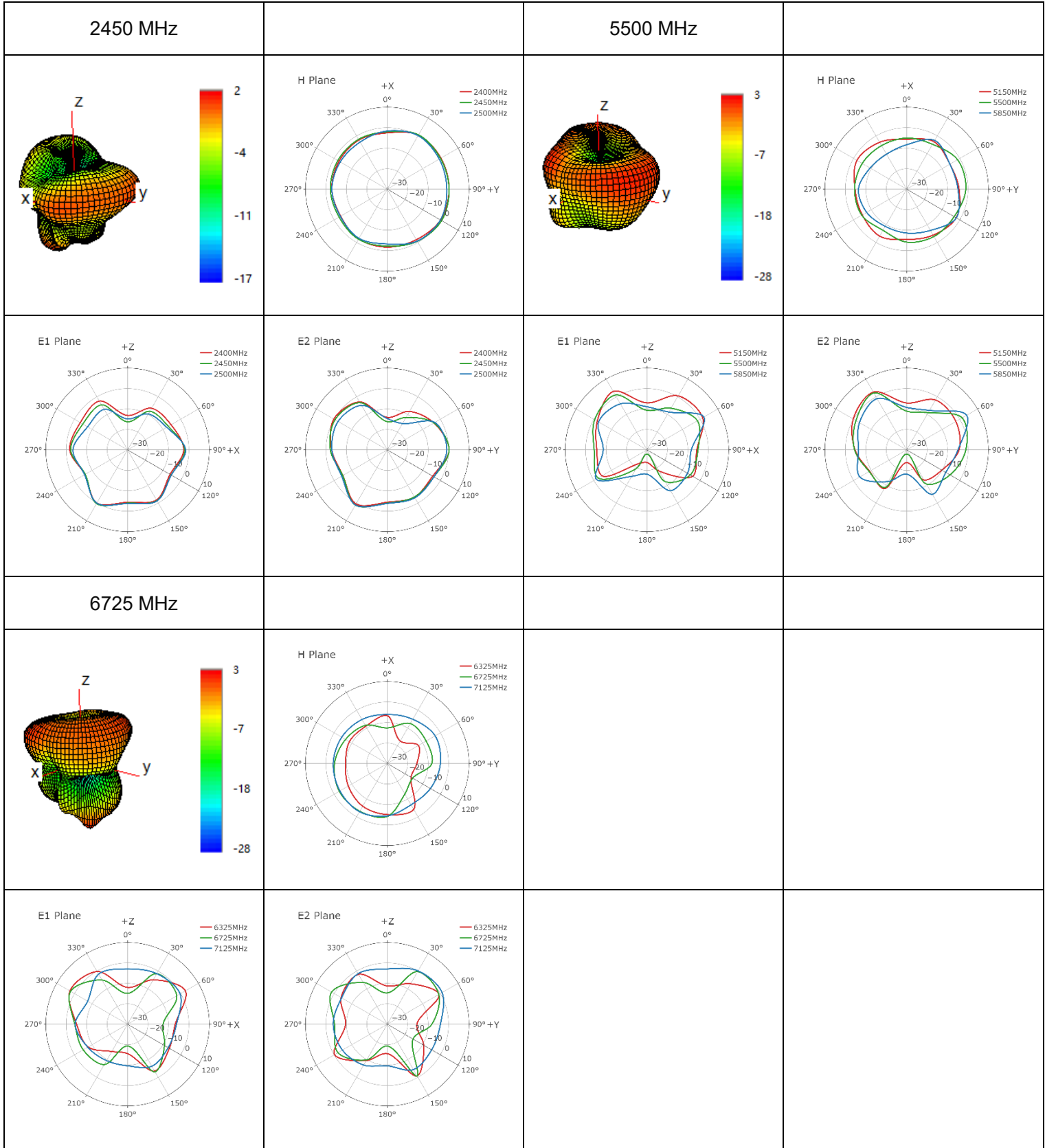

**3.2.4.2. Test Condition: On 130 mm × 70 mm EVB**

- Test Chamber: FS-G-1

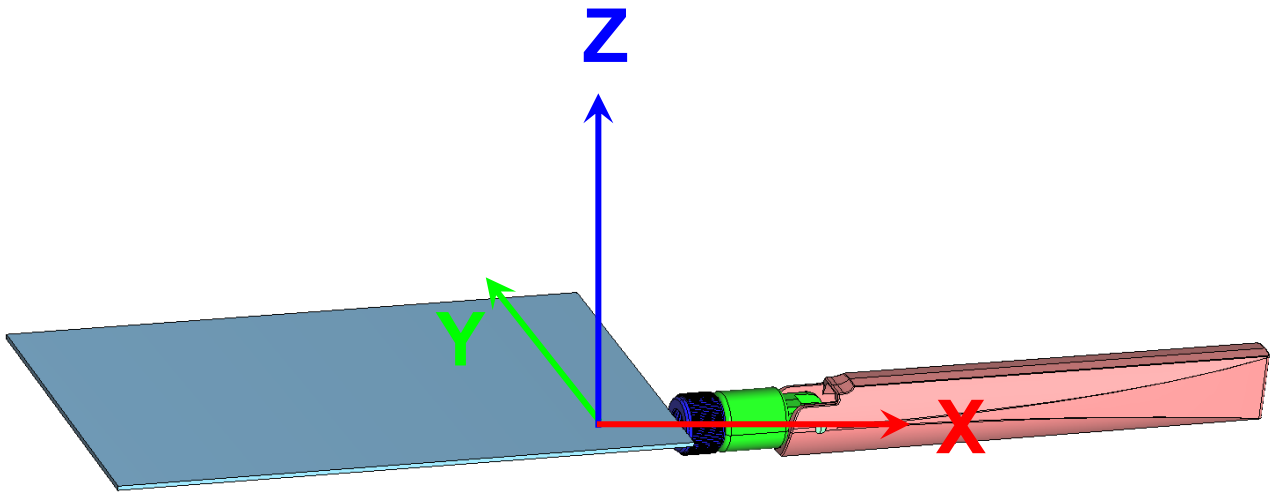

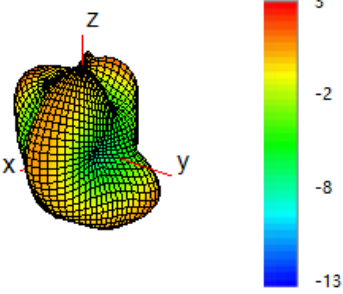
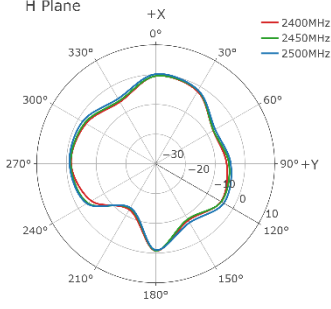
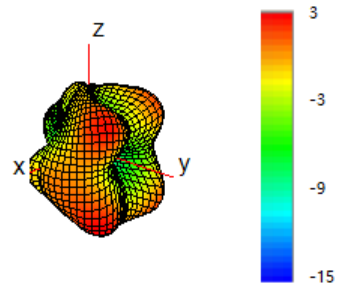
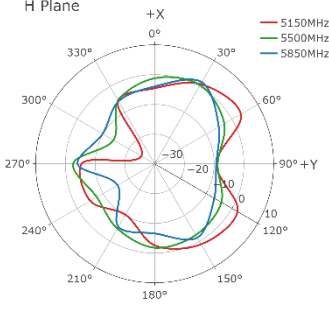
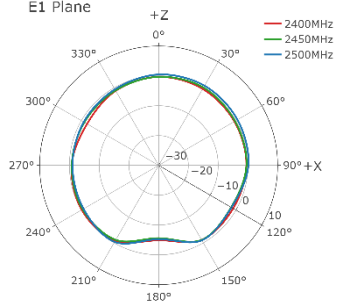
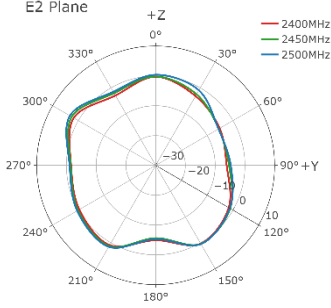
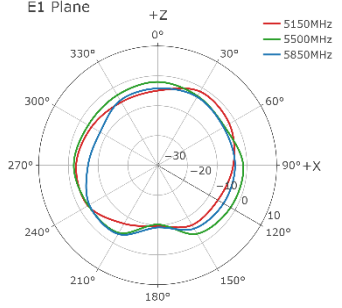
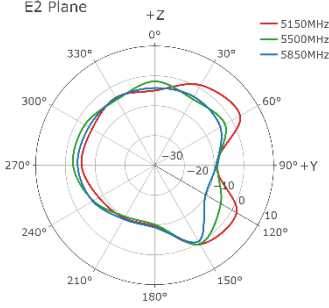
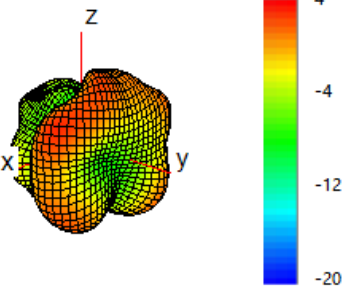
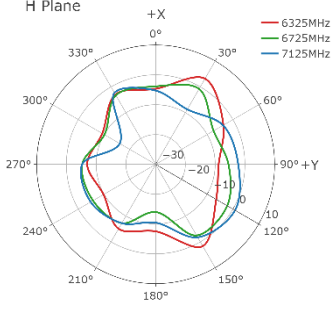
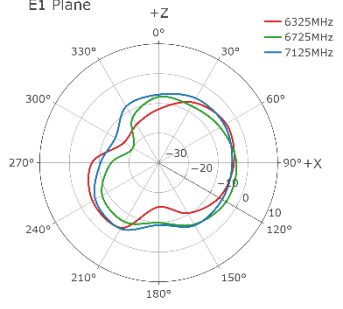
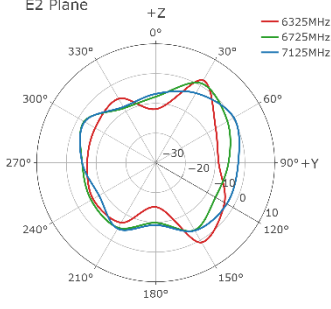
2450 MHz		5500 MHz	
	<p>H Plane</p> 		<p>H Plane</p> 
<p>E1 Plane</p> 	<p>E2 Plane</p> 	<p>E1 Plane</p> 	<p>E2 Plane</p> 
6725 MHz			
	<p>H Plane</p> 		
<p>E1 Plane</p> 	<p>E2 Plane</p> 		

# 4 Packaging

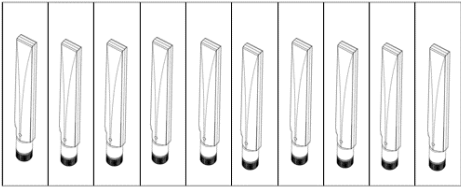
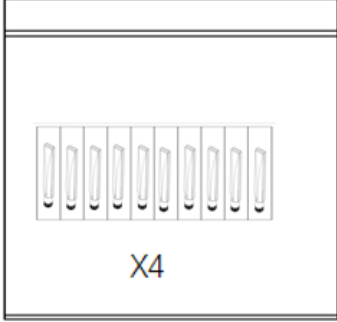
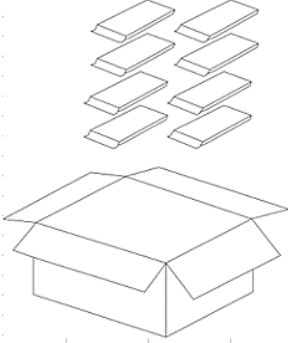
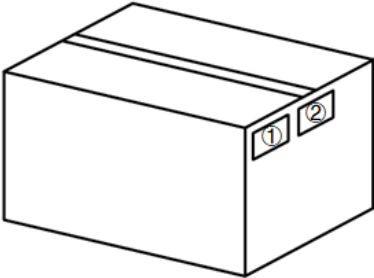
Step	Packaging Picture / 2D Picture	Description
1		<p>10 pcs antenna products in a one-piece bag. (10 PCS / One-piece Bag)</p>
2		<p>40 pcs antenna products in a PE bag. (40 PCS Antennas / PE Bag)</p>
3		<p>(8 PE Bags / Carton Box) (320 PCS Antennas / Carton Box) Estimated quantity Products that cannot fill the entire carton box are packed in a suitable size carton box. <u>Carton Size:</u> <u>L x W x H = 325 x 325 x 200 mm</u></p>
4		<p><b>Position for Attaching Labels</b></p> <ul style="list-style-type: none"> <li>① Carton Label</li> <li>② Quality Label</li> </ul>

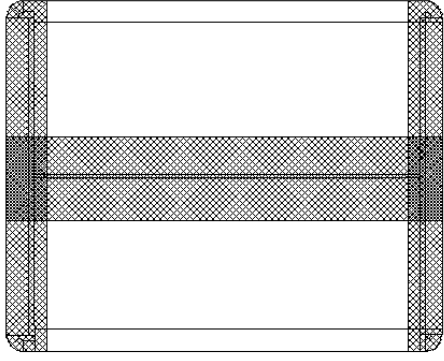
5	 A technical drawing of an H-shaped sealing carton. It consists of a central horizontal rectangular section with a cross-hatched texture, flanked by two vertical rectangular sections, also with a cross-hatched texture. The corners of the vertical sections are rounded. The entire structure is shown in a perspective view.	<b>Sealing Cartons</b> H-shaped sealing cartons
Note	The initial packaging method described above is for reference only, and the final actual packaging method shall be subject to the actual shipping packaging.	

# Contact Us

**At Quectel, our aim is to provide timely and comprehensive services to our customers. If you require any assistance, please contact our headquarters:**

**Quectel Wireless Solutions Co., Ltd.**

Building 5, Shanghai Business Park Phase III (Area B), No.1016 Tianlin Road, Minhang District, Shanghai 200233, China

Tel: +86 21 5108 6236

Email: [info@quectel.com](mailto:info@quectel.com)

**Or our local offices. For more information, please visit:**

<http://www.quectel.com/support/sales.htm>.

**For technical support, or to report documentation errors, please visit:**

<http://www.quectel.com/support/technical.htm>.

Or email us at: [support@quectel.com](mailto:support@quectel.com).

# Legal Notices

We offer information as a service to you. The provided information is based on your requirements and we make every effort to ensure its quality. You agree that you are responsible for using independent analysis and evaluation in designing intended products, and we provide reference designs for illustrative purposes only. Before using any hardware, software or service guided by this document, please read this notice carefully. Even though we employ commercially reasonable efforts to provide the best possible experience, you hereby acknowledge and agree that this document and related services hereunder are provided to you on an “as available” basis. We may revise or restate this document from time to time at our sole discretion without any prior notice to you.

## Use and Disclosure Restrictions

### License Agreements

Documents and information provided by us shall be kept confidential, unless specific permission is granted. They shall not be accessed or used for any purpose except as expressly provided herein.

### Copyright

Our and third-party products hereunder may contain copyrighted material. Such copyrighted material shall not be copied, reproduced, distributed, merged, published, translated, or modified without prior written consent. We and the third party have exclusive rights over copyrighted material. No license shall be granted or conveyed under any patents, copyrights, trademarks, or service mark rights. To avoid ambiguities, purchasing in any form cannot be deemed as granting a license other than the normal non-exclusive, royalty-free license to use the material. We reserve the right to take legal action for noncompliance with abovementioned requirements, unauthorized use, or other illegal or malicious use of the material.

### Trademarks

Except as otherwise set forth herein, nothing in this document shall be construed as conferring any rights to use any trademark, trade name or name, abbreviation, or counterfeit product thereof owned by Quectel or any third party in advertising, publicity, or other aspects.

### Third-Party Rights

This document may refer to hardware, software and/or documentation owned by one or more third parties (“third-party materials”). Use of such third-party materials shall be governed by all restrictions and obligations applicable thereto.

We make no warranty or representation, either express or implied, regarding the third-party materials, including but not limited to any implied or statutory, warranties of merchantability or fitness for a particular purpose, quiet enjoyment, system integration, information accuracy, and non-infringement of any third-party intellectual property rights with regard to the licensed technology or use thereof. Nothing herein constitutes a representation or warranty by us to either develop, enhance, modify, distribute, market, sell, offer for sale, or otherwise maintain production of any our products or any other hardware, software, device, tool, information, or product. We moreover disclaim any and all warranties arising from the course of dealing or usage of trade.

## Privacy Policy

To implement module functionality, certain device data are uploaded to Quectel's or third-party's servers, including carriers, chipset suppliers or customer-designated servers. Quectel, strictly abiding by the relevant laws and regulations, shall retain, use, disclose or otherwise process relevant data for the purpose of performing the service only or as permitted by applicable laws. Before data interaction with third parties, please be informed of their privacy and data security policy.

## Disclaimer

- a) We acknowledge no liability for any injury or damage arising from the reliance upon the information.
- b) We shall bear no liability resulting from any inaccuracies or omissions, or from the use of the information contained herein.
- c) While we have made every effort to ensure that the functions and features under development are free from errors, it is possible that they could contain errors, inaccuracies, and omissions. Unless otherwise provided by valid agreement, we make no warranties of any kind, either implied or express, and exclude all liability for any loss or damage suffered in connection with the use of features and functions under development, to the maximum extent permitted by law, regardless of whether such loss or damage may have been foreseeable.
- d) We are not responsible for the accessibility, safety, accuracy, availability, legality, or completeness of information, advertising, commercial offers, products, services, and materials on third-party websites and third-party resources.

**Copyright © Quectel Wireless Solutions Co., Ltd. 2025. All rights reserved.**

# Revision History

Version	Date	Author	Note
-	2025-05-19	Mordecai LIU/ Lance SUN/ Riva REN/ Rainey LIAO	Creation of the document
1.0	2025-05-19	Mordecai LIU/ Lance SUN/ Riva REN/ Rainey LIAO	First official release

**QUECTEL**

[www.quectel.com](http://www.quectel.com)