



Antenna Datasheet

Product OC: YEVT001W7AM

Version: 1.0

Date: 2025-05-26

Status: Released

Product Name: V2X Terminal Mount Fiberglass Array External Antenna

Key Features:

Frequency Band: 5850–5925 MHz

Dimensions: Φ 25.5 mm \times 600 mm

Efficiency: Up to 65 %

RoHS and REACH Compliant

IP Rating: IP67

Overview

The YEVT001W7AM is a V2X fiberglass antenna measuring Φ 25.5 mm × 600 mm. This ultra-wide-band V2X antenna provides broad coverage from 5850–5925 MHz. The antenna is terminated with N type Male connectors. This low profile, terminal mount omni-directional antenna, ideal for applications where the antenna is required to be discrete, is easy to install with maximum durability assured thanks to its IP67 rated FRP enclosure. It is compatible with Quectel's RM520x Series modules.

The antenna is designed as Array type to work in free space. It is a perfect antenna product for customers that desire highest performance. This omni-directional antenna is ideally suited for microwave communication equipment, communication base station, radio and television system, weather radar, offering great performance with its high gain and efficiency.

Typical applications include:

- Microwave Communication Equipment
- Communication Base Station
- Radio and Television System
- Weather Radar

Quectel provides comprehensive antenna design support such as simulation, testing and manufacturing for custom antenna solutions to meet your specific application needs. We have regional R & D centers to offer quick response to meet your requirements. Please contact our sales & FAEs if you have any requests.

Contents

Overview	1
Contents	2
1 Specification	3
1.1. Electrical.....	3
1.2. Mechanical & Environmental	4
2 Drawing	5
3 Detailed Performance	6
3.1. S-Parameter Test	6
3.1.1. VSWR	6
3.1.2. Return Loss.....	7
3.2. Radiation Performance Test.....	8
3.2.1. Efficiency.....	8
3.2.2. Average Gain	9
3.2.3. Peak Gain	10
3.2.4. 3D & 2D Radiation Pattern	11
4 Packaging	13
Contact Us	15
Legal Notices	16
Revision History	18

1 Specification

Test Condition: Free Space

1.1. Electrical

Electrical	
Frequency Range	5850–5925 MHz
Impedance	50 Ω
Polarization	Linear
Radiation Pattern	Omni-directional

SPEC	Band	Band	V2X
		Freq. (MHz)	5850–5925
Max VSWR			1.8
Max Return Loss (dB)			-10.9
AVG Eff. (%)			62
AVG. AVG Gain (dB)			-2.1
Max Peak Gain (dBi)			7.1 (5870)

1.2. Mechanical & Environmental

Mechanical	
Antenna Dimensions	Φ 25.5 mm × 600 mm
Material & Color	FRP & White
Connector Type	N-MALE
Mounting Type	Terminal
Weight	Typ. 220 g
Environmental	
Operation Temperature	-40 °C to +85 °C
Storage Temperature	-40 °C to +85 °C
Ingress Protection (IP) Rating	IP67 (After Installation)
RoHS and REACH Compliant	Yes

2 Drawing

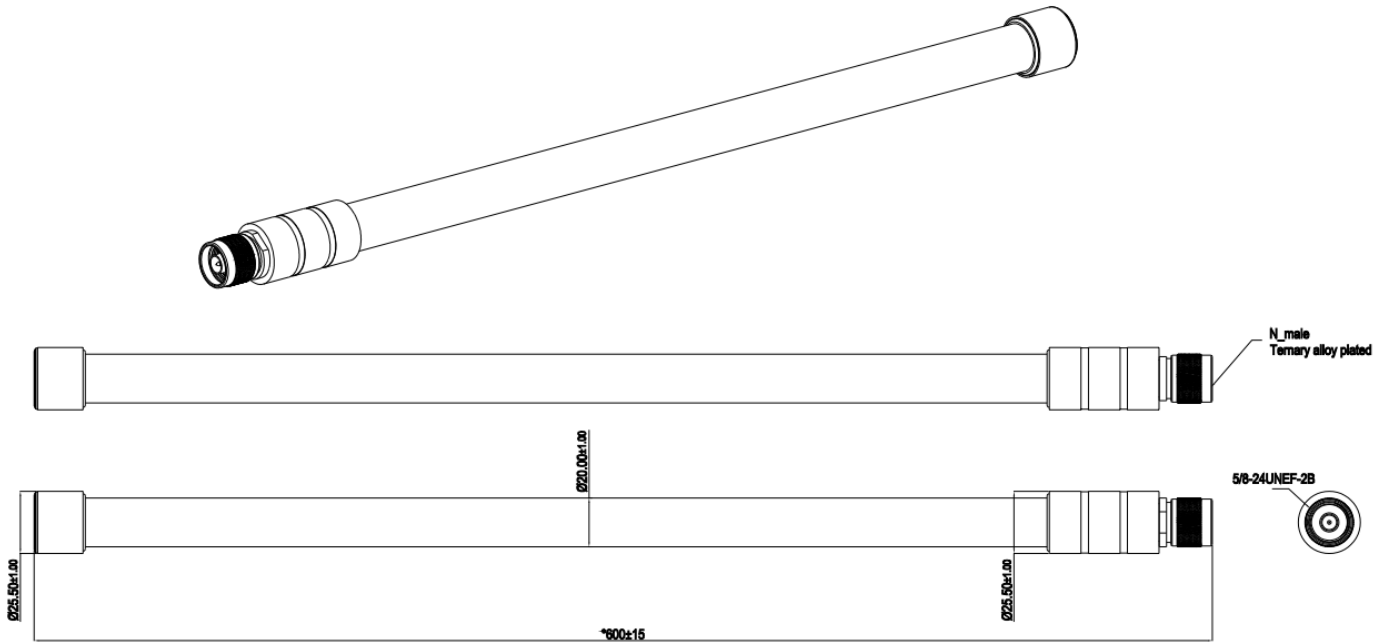

Unit: mm

3 Detailed Performance

3.1. S-Parameter Test

3.1.1. VSWR

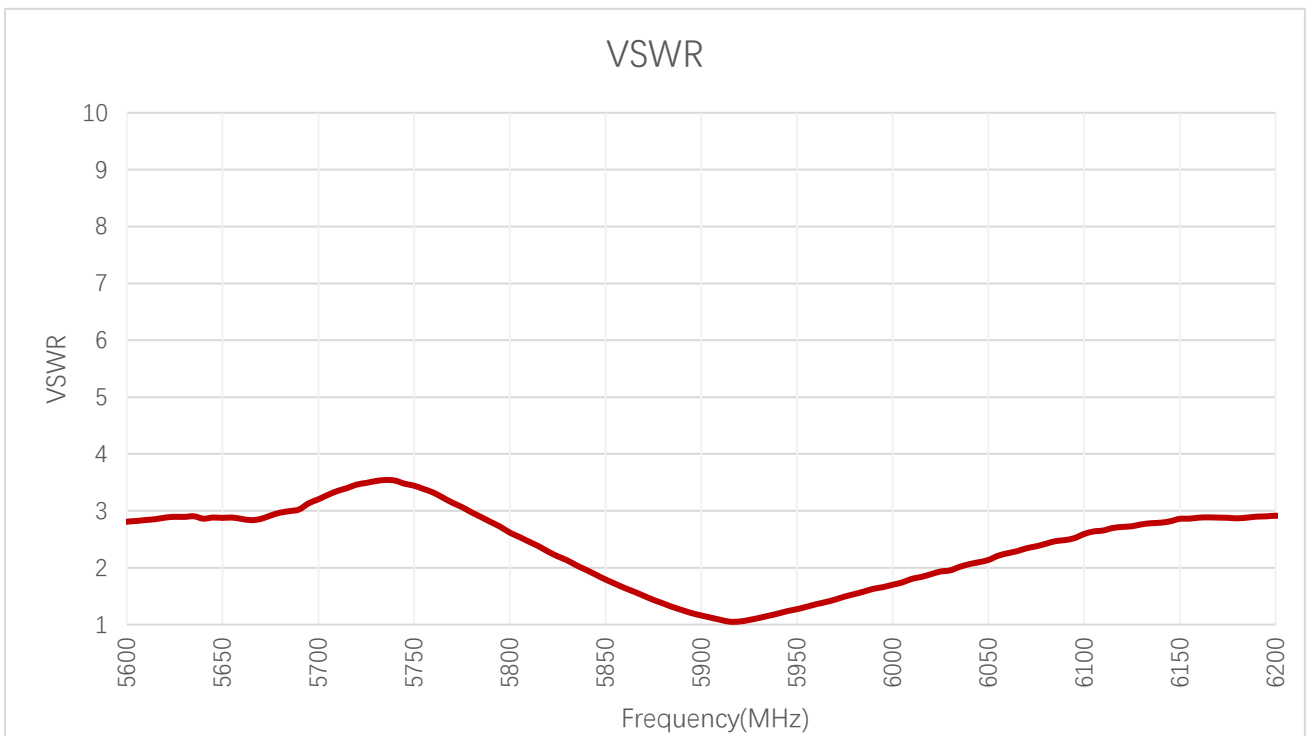

VSWR

Frequency (MHz)	5850	5885	5925
VSWR	1.8	1.3	1.1

3.1.2. Return Loss

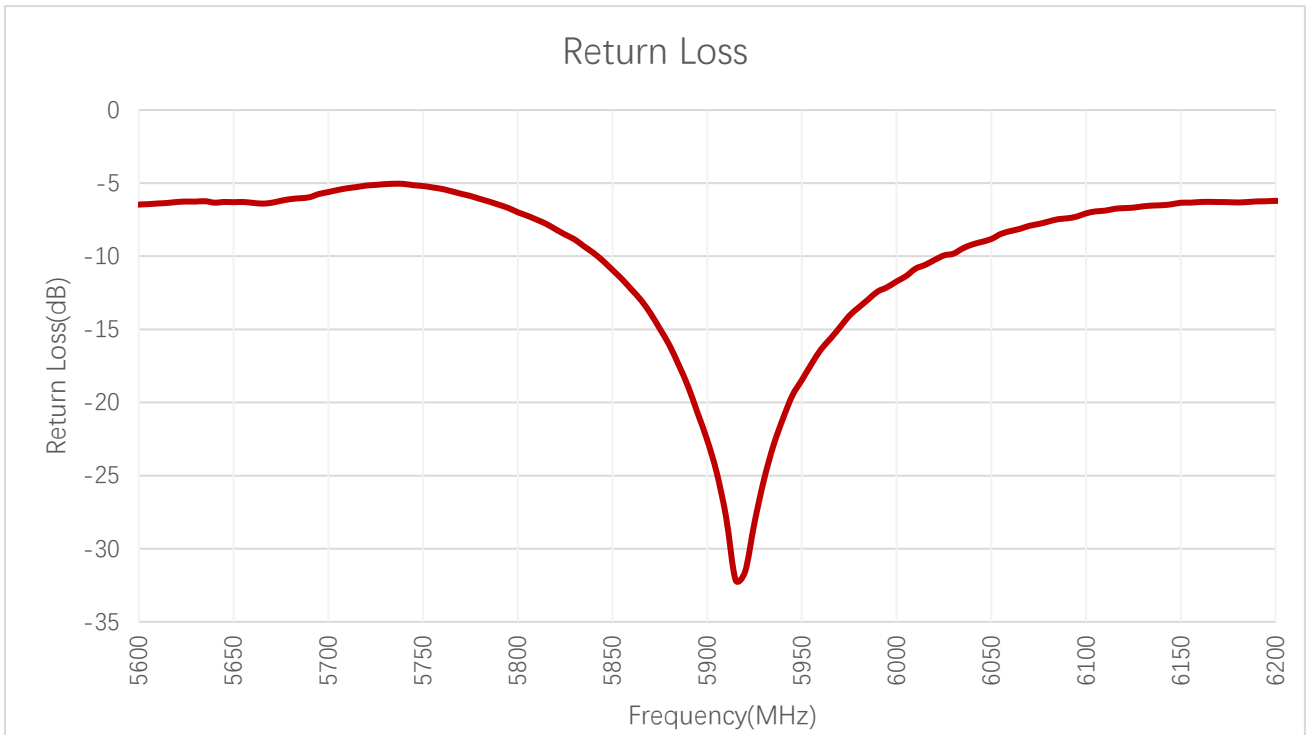

Return Loss (dB)

Frequency (MHz)	5850	5885	5925
Return Loss (dB)	-10.9	-17.4	-28.2

3.2. Radiation Performance Test

3.2.1. Efficiency



Efficiency (%)

Frequency (MHz)	5850	5885	5925
Efficiency (%)	59.5	65.1	61.6

3.2.2. Average Gain

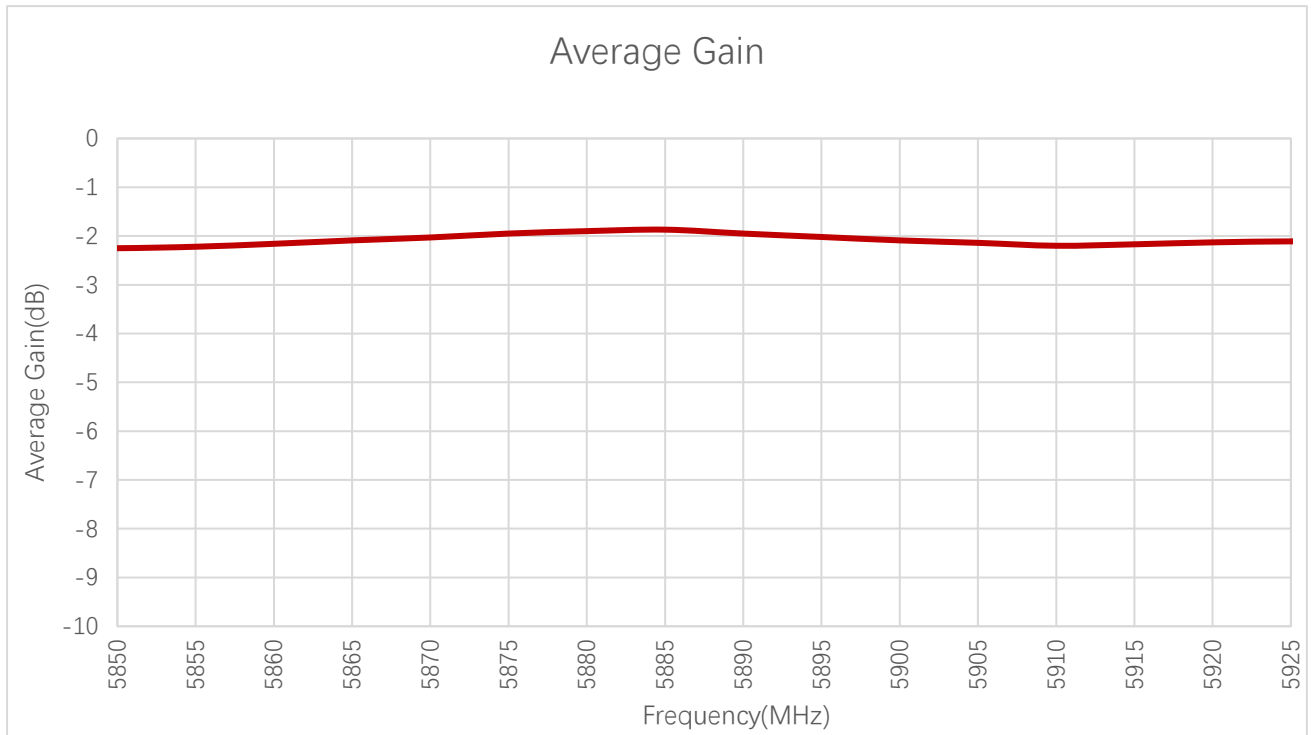

Average Gain (dB)

Frequency (MHz)	5850	5885	5925
Average Gain (dB)	-2.3	-1.9	-2.1

3.2.3. Peak Gain

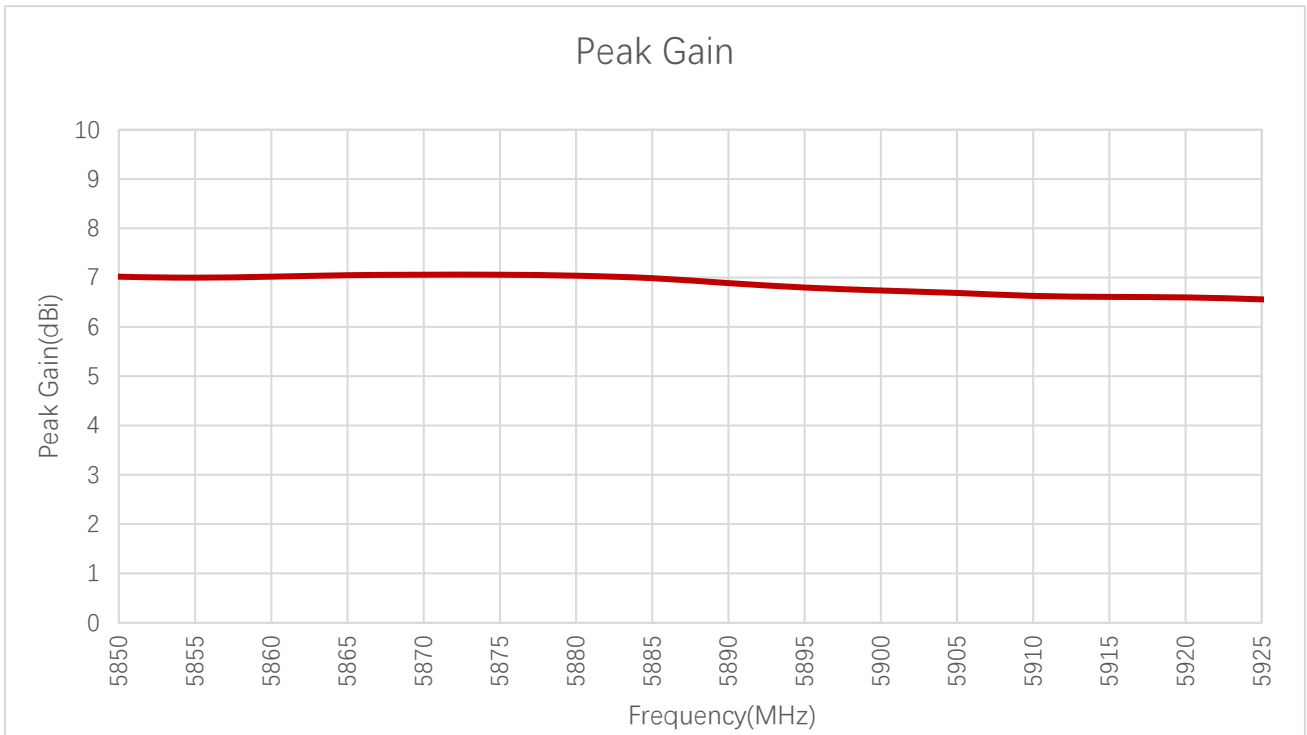

Peak Gain (dBi)

Frequency (MHz)	5850	5885	5925
Peak Gain (dBi)	7.0	7.0	6.6

3.2.4. 3D & 2D Radiation Pattern

- Test Condition: Free Space
- Test Chamber: HF-S-1

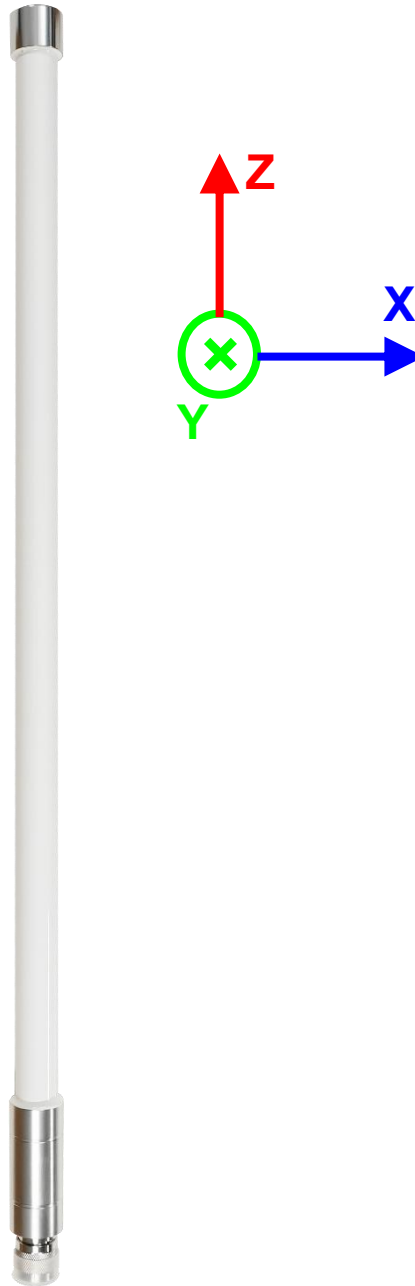

● **V2X**

5885 MHz

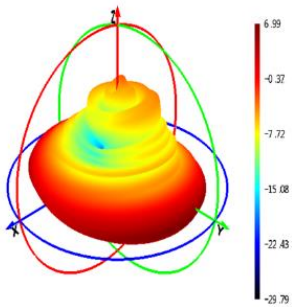

Theta=90

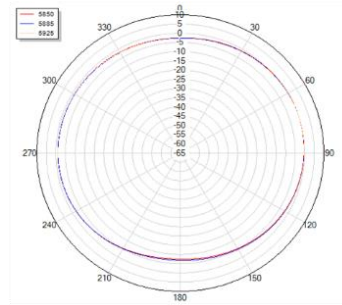

Phi=0

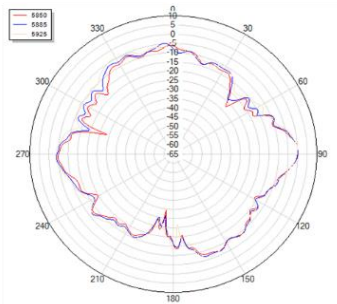

Phi=90

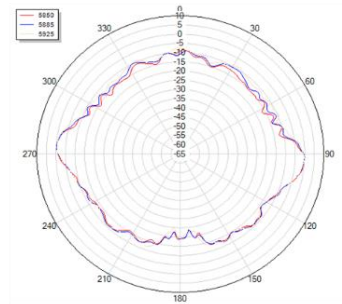

● **Max Peak Gain**

5870 MHz

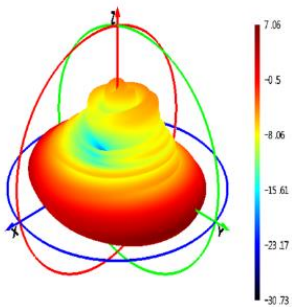

Theta=90

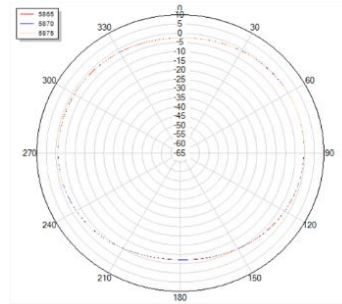

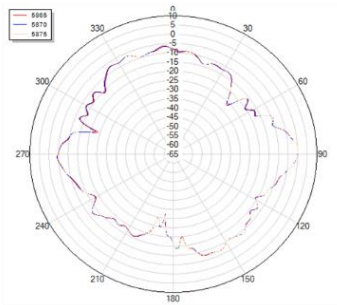

Phi=0

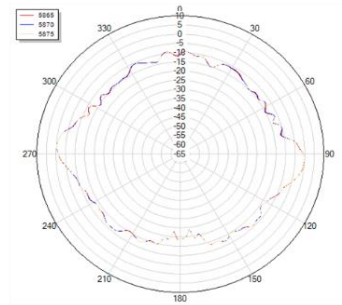

Phi=90

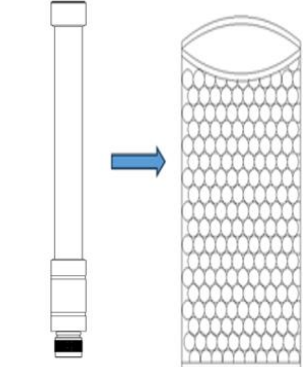
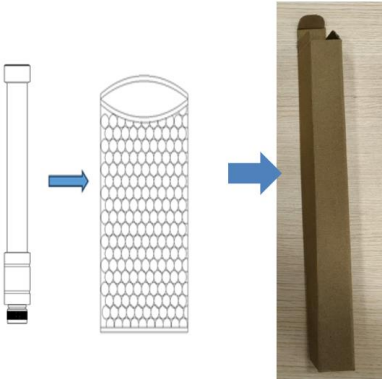

4 Packaging

Step	Packaging picture / 2D picture	Description
1	 <p>The diagram shows a vertical antenna product on the left. A blue arrow points to a bubble bag on the right, which is partially filled with bubbles and has a circular opening at the top.</p>	<p>1 pc antenna product in a bubble bag. (1 PC Antenna / Bubble Bag)</p>
2	 <p>The diagram shows the antenna product on the left, a bubble bag in the middle, and a brown cardboard inner box on the right. Blue arrows indicate the flow from the antenna to the bubble bag, and then from the bubble bag to the inner box.</p>	<p>1 pc antenna product in an inner box. (1 PC Antenna / Inner Box)</p>
3	 <p>The photograph shows the interior of a large cardboard carton box. It is filled with several vertical, rectangular inner boxes, arranged in a row.</p>	<p>20 pcs inner boxes in a carton box. (20 PCS Antennas / Carton Box) Estimated quantity Products that cannot fill the entire carton box are packed in a suitable size carton box. <u>Carton Size:</u> <u>L × W × H = 640 × 480 × 125 mm</u></p>

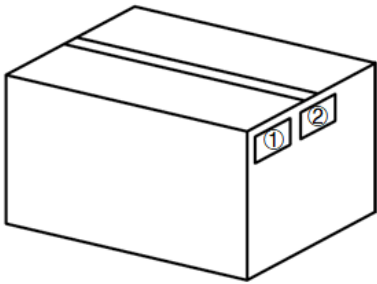
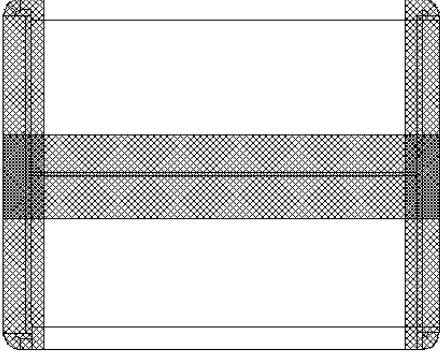
<p>4</p>		<p>Position for Attaching Labels</p> <ul style="list-style-type: none"> ① Carton Label ② Quality Label
<p>5</p>		<p>Sealing Cartons H-shaped sealing cartons</p>
<p>Note</p>	<p>The initial packaging method described above is for reference only, and the final actual packaging method shall be subject to the actual shipping packaging.</p>	

Contact Us

At Quectel, our aim is to provide timely and comprehensive services to our customers. If you require any assistance, please contact our headquarters:

Quectel Wireless Solutions Co., Ltd.

Building 5, Shanghai Business Park Phase III (Area B), No.1016 Tianlin Road, Minhang District, Shanghai 200233, China

Tel: +86 21 5108 6236

Email: info@quectel.com

Or our local offices. For more information, please visit:

<http://www.quectel.com/support/sales.htm>.

For technical support, or to report documentation errors, please visit:

<http://www.quectel.com/support/technical.htm>.

Or email us at: support@quectel.com.

Legal Notices

We offer information as a service to you. The provided information is based on your requirements and we make every effort to ensure its quality. You agree that you are responsible for using independent analysis and evaluation in designing intended products, and we provide reference designs for illustrative purposes only. Before using any hardware, software or service guided by this document, please read this notice carefully. Even though we employ commercially reasonable efforts to provide the best possible experience, you hereby acknowledge and agree that this document and related services hereunder are provided to you on an “as available” basis. We may revise or restate this document from time to time at our sole discretion without any prior notice to you.

Use and Disclosure Restrictions

License Agreements

Documents and information provided by us shall be kept confidential, unless specific permission is granted. They shall not be accessed or used for any purpose except as expressly provided herein.

Copyright

Our and third-party products hereunder may contain copyrighted material. Such copyrighted material shall not be copied, reproduced, distributed, merged, published, translated, or modified without prior written consent. We and the third party have exclusive rights over copyrighted material. No license shall be granted or conveyed under any patents, copyrights, trademarks, or service mark rights. To avoid ambiguities, purchasing in any form cannot be deemed as granting a license other than the normal non-exclusive, royalty-free license to use the material. We reserve the right to take legal action for noncompliance with abovementioned requirements, unauthorized use, or other illegal or malicious use of the material.

Trademarks

Except as otherwise set forth herein, nothing in this document shall be construed as conferring any rights to use any trademark, trade name or name, abbreviation, or counterfeit product thereof owned by Quectel or any third party in advertising, publicity, or other aspects.

Third-Party Rights

This document may refer to hardware, software and/or documentation owned by one or more third parties (“third-party materials”). Use of such third-party materials shall be governed by all restrictions and obligations applicable thereto.

We make no warranty or representation, either express or implied, regarding the third-party materials, including but not limited to any implied or statutory, warranties of merchantability or fitness for a particular purpose, quiet enjoyment, system integration, information accuracy, and non-infringement of any third-party intellectual property rights with regard to the licensed technology or use thereof. Nothing herein constitutes a representation or warranty by us to either develop, enhance, modify, distribute, market, sell, offer for sale, or otherwise maintain production of any our products or any other hardware, software, device, tool, information, or product. We moreover disclaim any and all warranties arising from the course of dealing or usage of trade.

Privacy Policy

To implement module functionality, certain device data are uploaded to Quectel's or third-party's servers, including carriers, chipset suppliers or customer-designated servers. Quectel, strictly abiding by the relevant laws and regulations, shall retain, use, disclose or otherwise process relevant data for the purpose of performing the service only or as permitted by applicable laws. Before data interaction with third parties, please be informed of their privacy and data security policy.

Disclaimer

- a) We acknowledge no liability for any injury or damage arising from the reliance upon the information.
- b) We shall bear no liability resulting from any inaccuracies or omissions, or from the use of the information contained herein.
- c) While we have made every effort to ensure that the functions and features under development are free from errors, it is possible that they could contain errors, inaccuracies, and omissions. Unless otherwise provided by valid agreement, we make no warranties of any kind, either implied or express, and exclude all liability for any loss or damage suffered in connection with the use of features and functions under development, to the maximum extent permitted by law, regardless of whether such loss or damage may have been foreseeable.
- d) We are not responsible for the accessibility, safety, accuracy, availability, legality, or completeness of information, advertising, commercial offers, products, services, and materials on third-party websites and third-party resources.

Copyright © Quectel Wireless Solutions Co., Ltd. 2025. All rights reserved.

Revision History

Version	Date	Author	Note
-	2025-05-26	Christopher YAO/ Lance SUN/ Riva REN/ Rainey LIAO	Creation of the document
1.0	2025-05-26	Christopher YAO/ Lance SUN/ Riva REN/ Rainey LIAO	First official release



www.quectel.com