



Antenna Datasheet

Product OC: YFGC035WWC

Version: 1.3

Date: 2024-12-16

Status: Released

Product Name: Passive GNSS L1 Antenna

Key Features:

Frequency Band: 1559–1606 MHz

Dimensions: 35 mm × 35 mm × 6 mm

Efficiency: Up to 68.7 %

RoHS and REACH Compliant

Overview

This Quectel GNSS antenna adopts a diversity of forms to guarantee the most suitable polarization type. Quectel's positioning products support single-band or multi-band operation modes to meet various high-precision positioning requirements of customers' products. Quectel provides both passive and active antennas to satisfy the customer demand for high gain. Such antenna supports different installation or connection methods such as pin mount, surface mount, magnetic mount, internal cable, and external SMA. Customized connector type and cable length are provided according to requirements.

Contents

| | |
|---|-----------|
| Overview | 1 |
| Contents | 2 |
| 1 Specification | 3 |
| 1.1. Electrical..... | 3 |
| 1.2. Mechanical & Environmental | 4 |
| 1.3. Supported GNSS Frequency Bands..... | 5 |
| 2 Drawing | 7 |
| 3 Detailed Performance | 8 |
| 3.1. S-Parameter Test | 8 |
| 3.1.1. VSWR | 8 |
| 3.1.2. Return Loss..... | 9 |
| 3.2. Radiation Performance Test..... | 10 |
| 3.2.1. Efficiency..... | 10 |
| 3.2.2. Peak Gain | 11 |
| 3.2.3. Axial Ratio..... | 12 |
| 3.2.4. 2D RHCP and LHCP Gain..... | 13 |
| 3.2.5. 3D & 2D Radiation Pattern | 16 |
| 4 PCB Footprint Recommendation | 18 |
| 5 Pin Definition | 19 |
| 6 Recommended Reflow Soldering Profile | 20 |
| 7 Packaging | 21 |
| Contact Us | 23 |
| Legal Notices | 24 |
| Revision History | 26 |

1 Specification

Test Condition: on 70 mm × 70 mm PCB

1.1. Electrical

| Electrical | |
|-------------------|---------------|
| Frequency Range | 1559–1606 MHz |
| Impedance | 50 Ω |
| Polarization | RHCP |
| Radiation Pattern | Directional |

| Band Frequency (MHz) | GPS L5 GALILEO E5a BDS B2a-B2I QZSS L5 IRNSS L5 | GALILEO E5b BDS B2b | GPS L2 QZSS L2C | GLONASS G2 | BDS B3 | BDS B1I | GPS L1 GALILEO E1 BDS B1C QZSS L1 | GLONASS G1 |
|----------------------------|--|---------------------------|-----------------------|---------------|--------|------------|---|---------------|
| | 1176 | 1207 | 1227 | 1248 | 1268 | 1561 | 1575 | 1602 |
| VSWR | - | - | - | - | - | 1.27 | 1.24 | 1.23 |
| Return Loss (dB) | - | - | - | - | - | -18.5 | -19.4 | -19.6 |
| Efficiency (%) | - | - | - | - | - | 63.0 | 68.7 | 66.1 |
| Peak Gain (dBi) | - | - | - | - | - | 3.1 | 3.8 | 3.7 |
| Axial Ratio (dB) | - | - | - | - | - | 1.9 | 1.6 | 1.2 |

1.2. Mechanical & Environmental

| Mechanical | |
|---|----------------------|
| Antenna Dimensions | 35 mm × 35 mm × 6 mm |
| Material | Ceramic |
| Mounting Type | Adhesive & Soldering |
| Weight | Typ. 27.3 g |
| Environmental | |
| Operation Temperature | -40 °C to +85 °C |
| Storage Temperature | -40 °C to +85 °C |
| Recommended Reflow Temperature and Time | 260 °C & 5 s |
| RoHS & REACH Compliant | Yes |

1.3. Supported GNSS Frequency Bands

| GNSS Frequency Bands (MHz) | | | | | |
|----------------------------|---|--|--|---|--|
| GPS | L1 Centre 1575.42 (1565–1586) | L2 Centre 1227.6 (1217–1238) | L5 Centre 1176.45 (1164–1189) | | |
| | √ | - | - | | |
| GLONASS | G1-L10C-L10F Centre 1601 (1595–1606) | G2-L20C-L20F Centre 1248.06 (1241–1255) | G3-L30C Centre 1202.025 (1189–1213) | | |
| | √ | - | - | | |
| GALILEO | E1 Centre 1575.42 (1563–1588) | E5a Centre 1176.45 (1166–1187) | E5b Centre 1207.14 (1197–1218) | E6 Centre 1278.75 (1258–1300) | |
| | √ | - | - | - | |
| BDS | B1I Centre 1561.098 (1559–1564) | B1C (BDS-3) Centre 1575.42 (1559–1592) | B2a-B2I Centre 1176.45 (1166–1187) | B2b Centre 1207.14 (1197–1217) | B3 Centre 1268.52 (1258–1279) |
| | √ | √ | - | - | - |
| QZSS | L1 Centre 1575.42 (1573–1578) | L2C Centre 1227.6 (1226–1229) | L5 Centre 1176.45 (1166–1187) | L6 Centre 1278.75 (1257–1300) | |
| | √ | - | - | - | |
| IRNSS | L5 Centre 1176.45 (1164–1189) | | | | |
| | - | | | | |

GNSS Bands and Constellations



2 Drawing

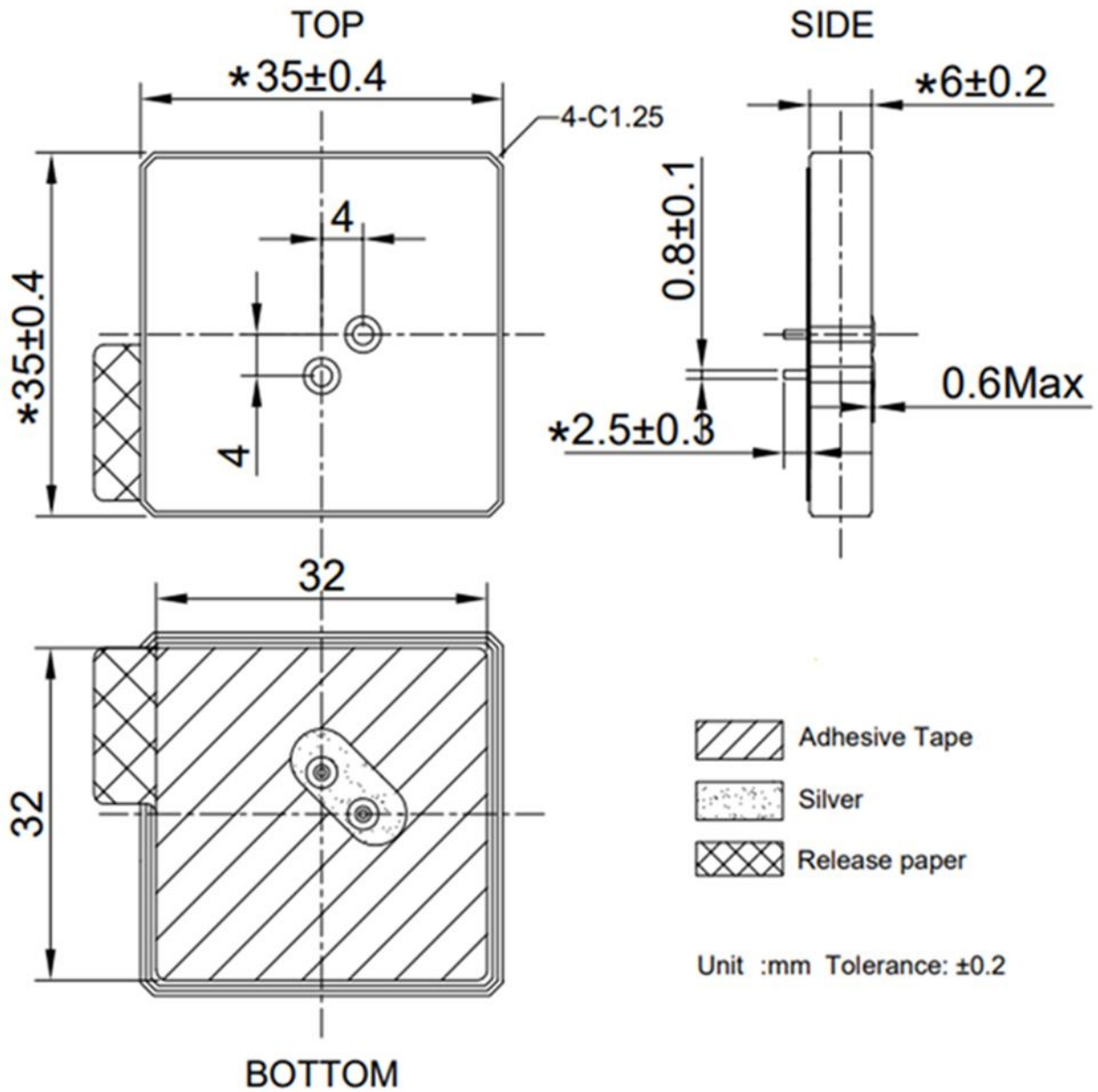

3 Detailed Performance

3.1. S-Parameter Test

3.1.1. VSWR

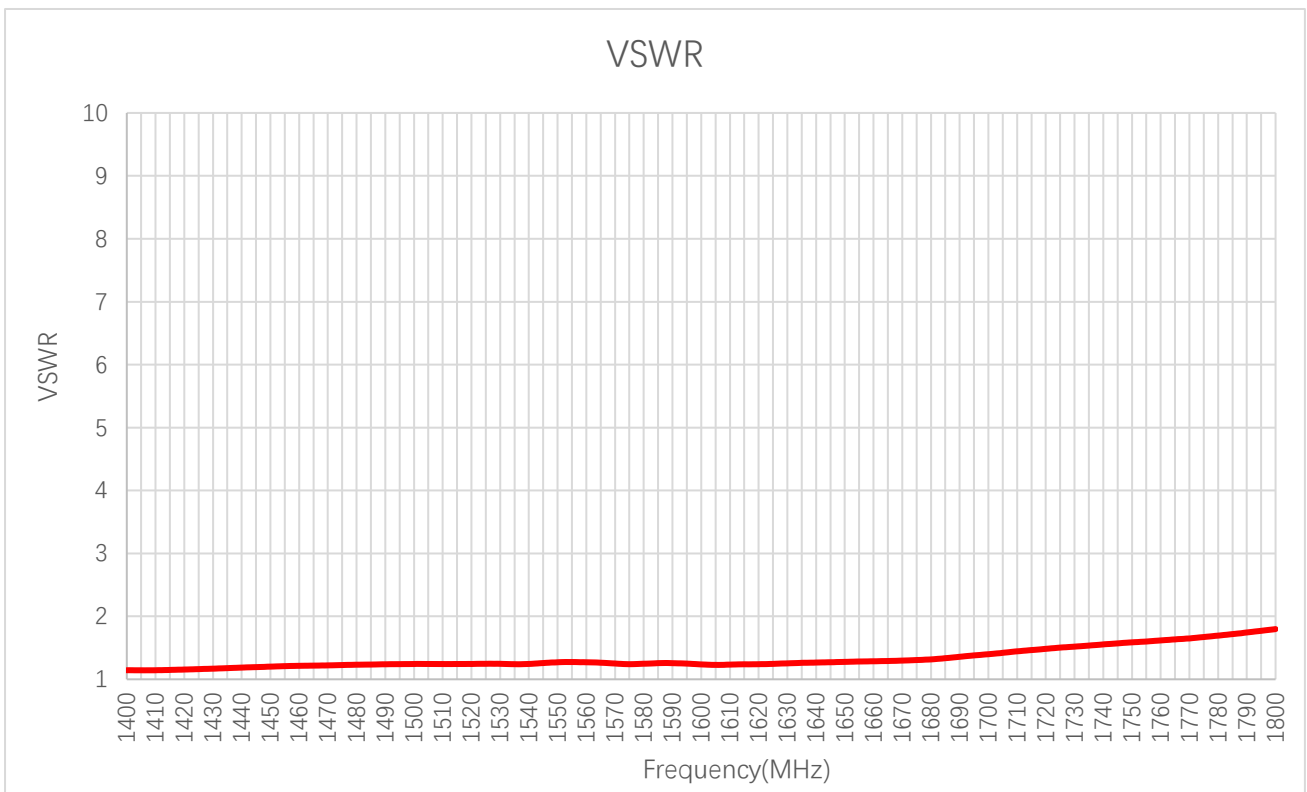

VSWR

| Frequency (MHz) | 1176 | 1207 | 1227 | 1248 | 1268 | 1561 | 1575 | 1602 |
|-----------------|------|------|------|------|------|------|------|------|
| VSWR | - | - | - | - | - | 1.27 | 1.24 | 1.23 |

3.1.2. Return Loss

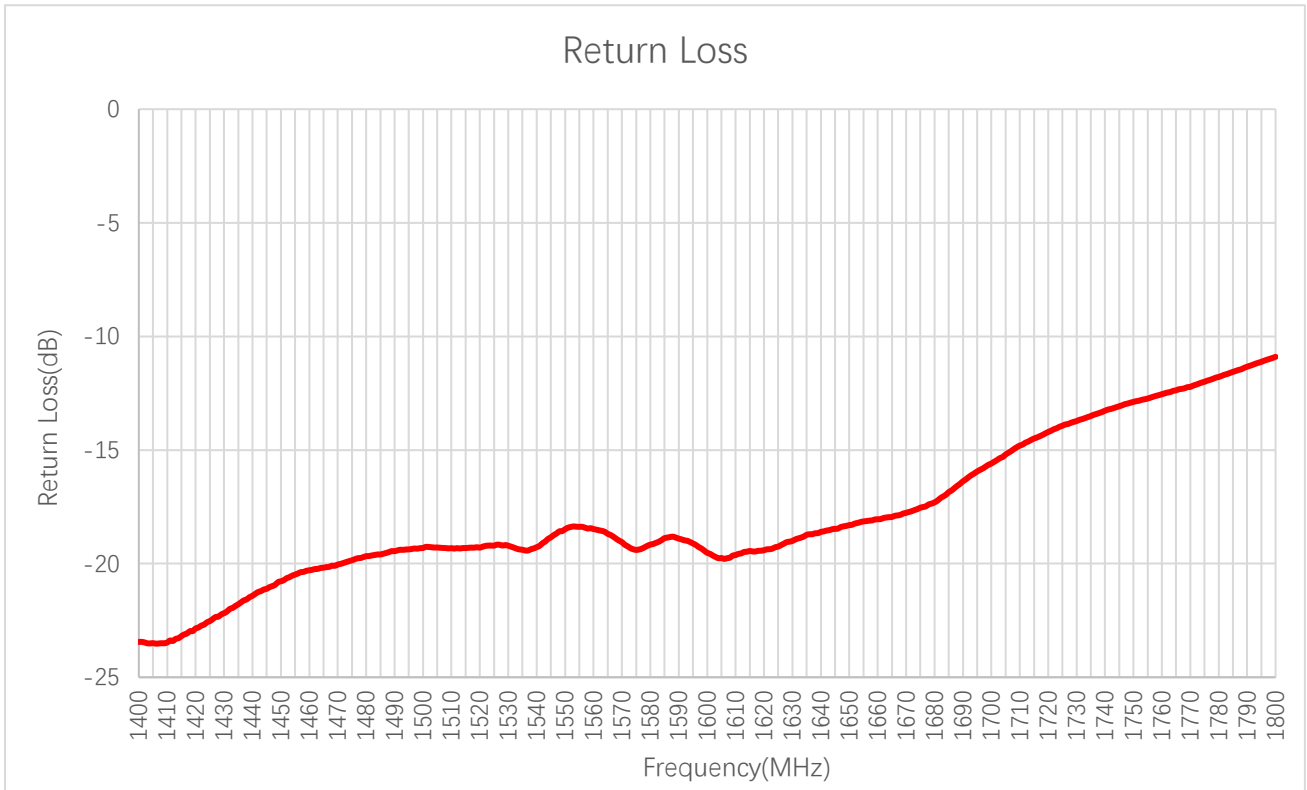

Return Loss (dB)

| Frequency (MHz) | 1176 | 1207 | 1227 | 1248 | 1268 | 1561 | 1575 | 1602 |
|------------------|------|------|------|------|------|-------|-------|-------|
| Return Loss (dB) | - | - | - | - | - | -18.5 | -19.4 | -19.6 |

3.2. Radiation Performance Test

3.2.1. Efficiency

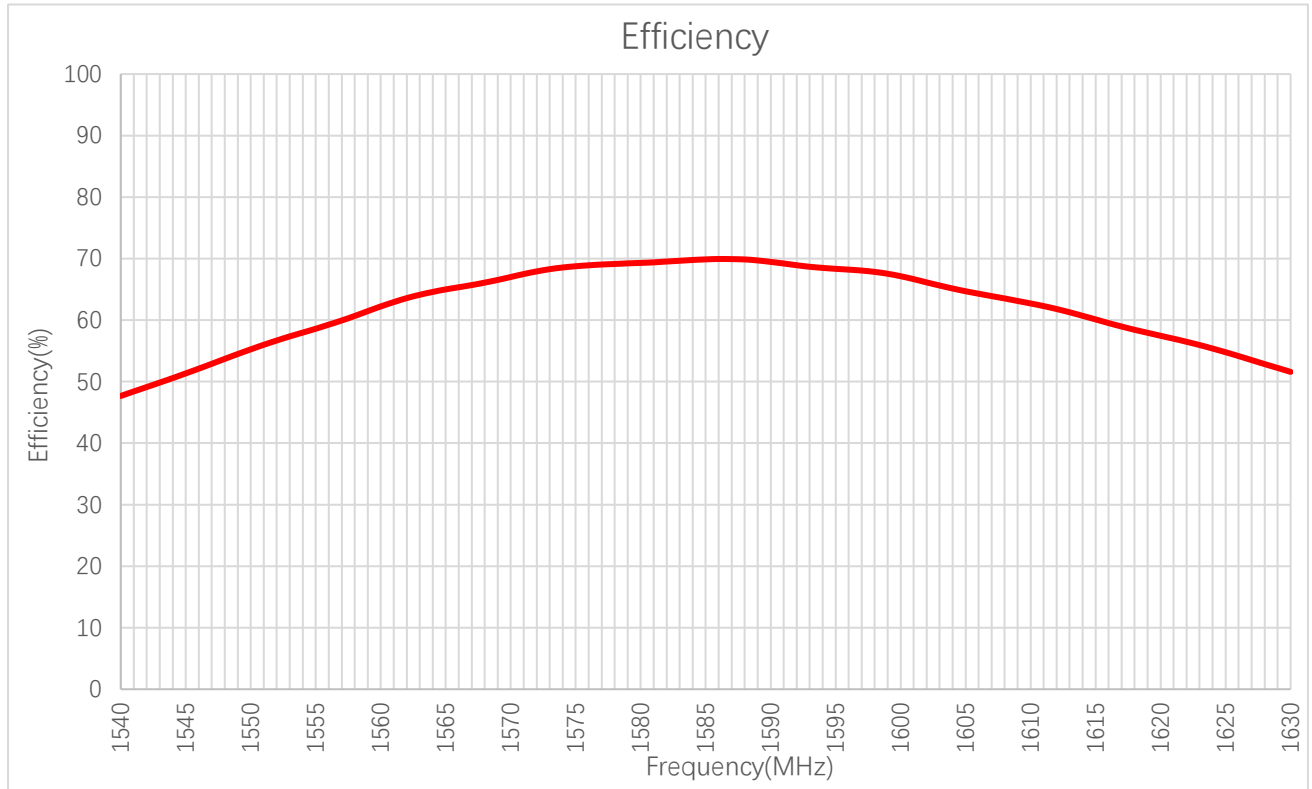

Efficiency (%)

| Frequency (MHz) | 1176 | 1207 | 1227 | 1248 | 1268 | 1561 | 1575 | 1602 |
|-----------------|------|------|------|------|------|------|------|------|
| Efficiency (%) | - | - | - | - | - | 63.0 | 68.7 | 66.1 |

3.2.2. Peak Gain

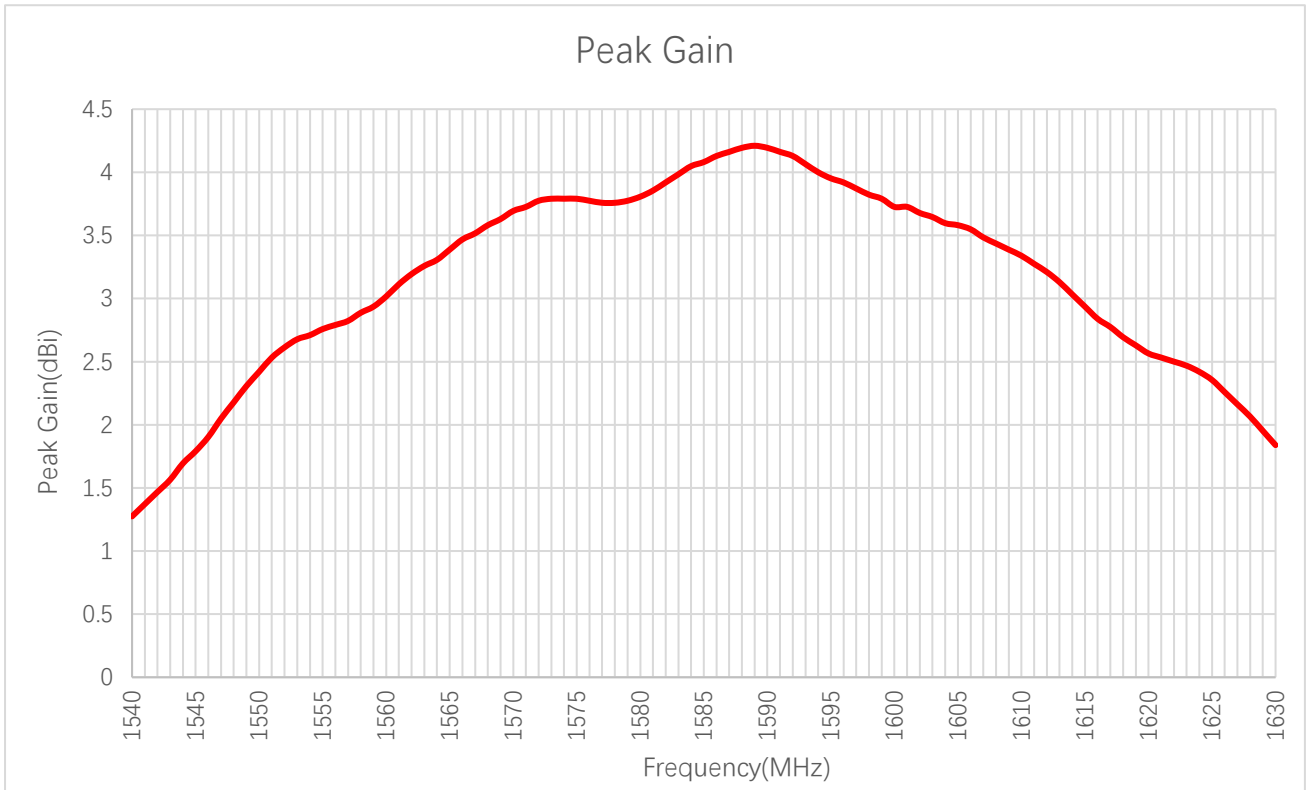

Peak Gain (dBi)

| Frequency (MHz) | 1176 | 1207 | 1227 | 1248 | 1268 | 1561 | 1575 | 1602 |
|-----------------|------|------|------|------|------|------|------|------|
| Peak Gain (dBi) | - | - | - | - | - | 3.1 | 3.8 | 3.7 |

3.2.3. Axial Ratio

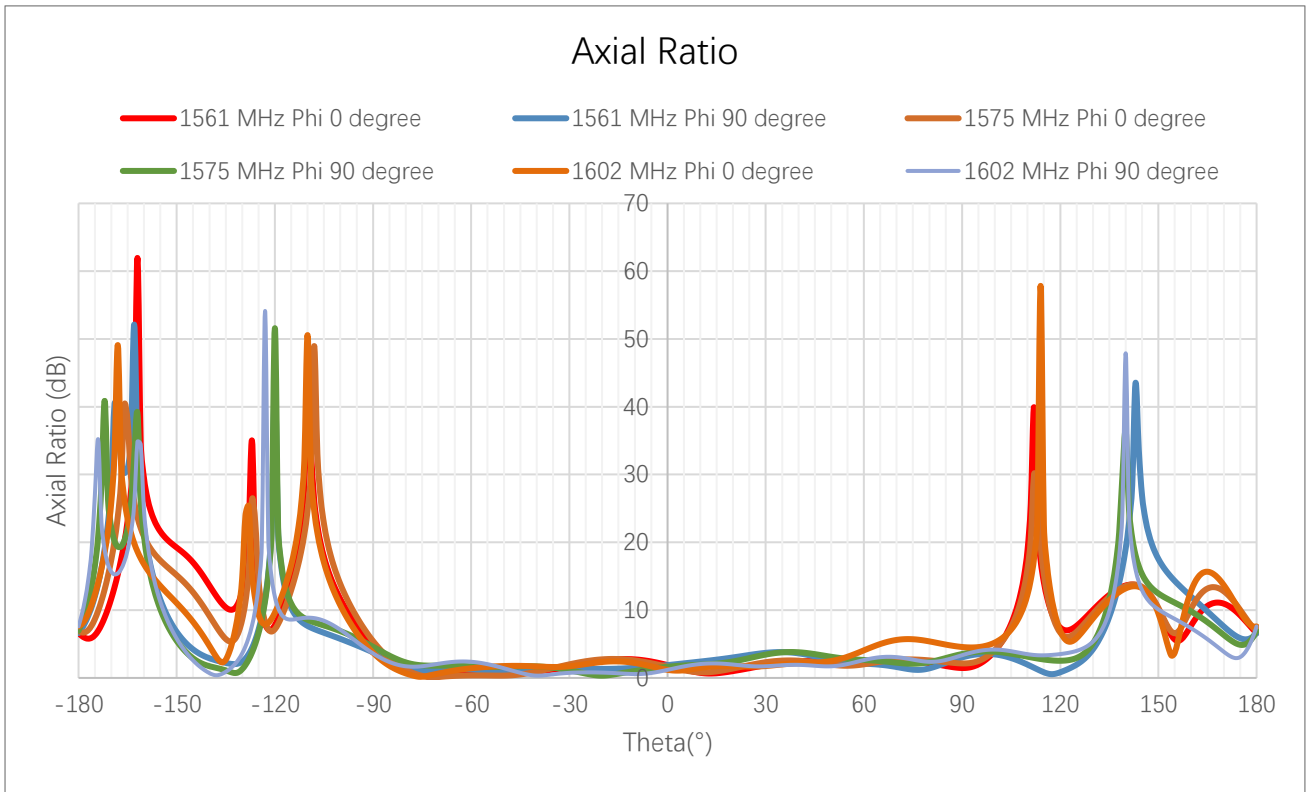

Axial Ratio (dB)

| Frequency (MHz) | | 1176 | 1207 | 1227 | 1248 | 1268 | 1561 | 1575 | 1602 |
|------------------|-----------------------------------|------|------|------|------|------|------|------|------|
| Axial Ratio (dB) | Phi = 0 (deg) Theta = 0 (deg) | - | - | - | - | - | 1.9 | 1.6 | 1.2 |
| | Phi = 90 (deg) Theta = 0 (deg) | - | - | - | - | - | 1.9 | 1.6 | 1.2 |

3.2.4. 2D RHCP and LHCP Gain

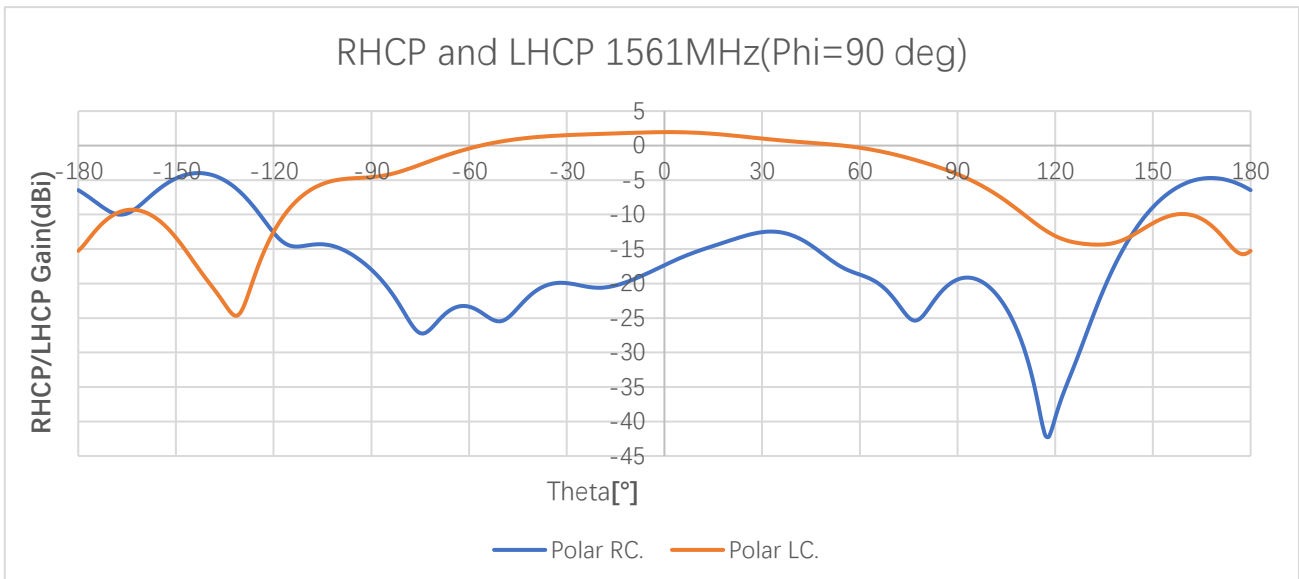
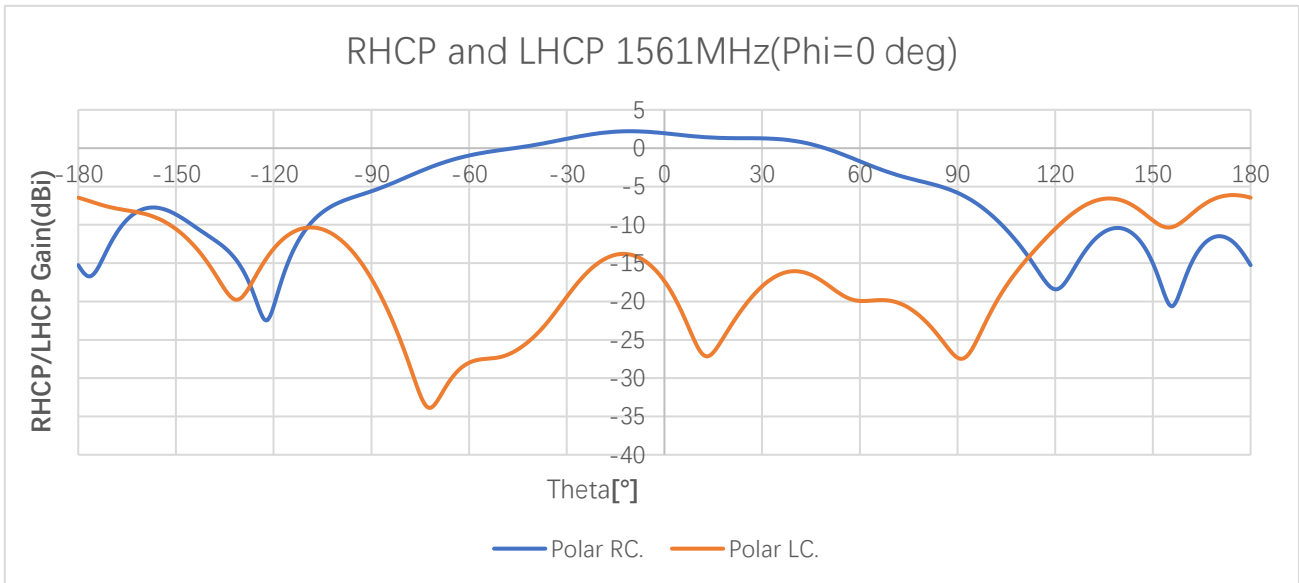

RHCP and LHCP 1575MHz(Phi=0 deg)

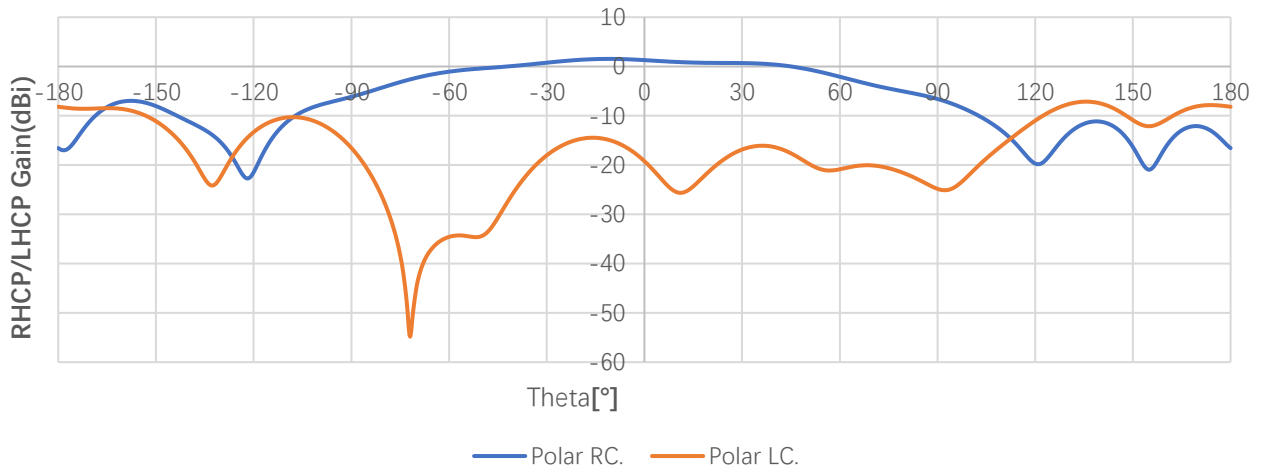

RHCP and LHCP 1575MHz(Phi=90 deg)

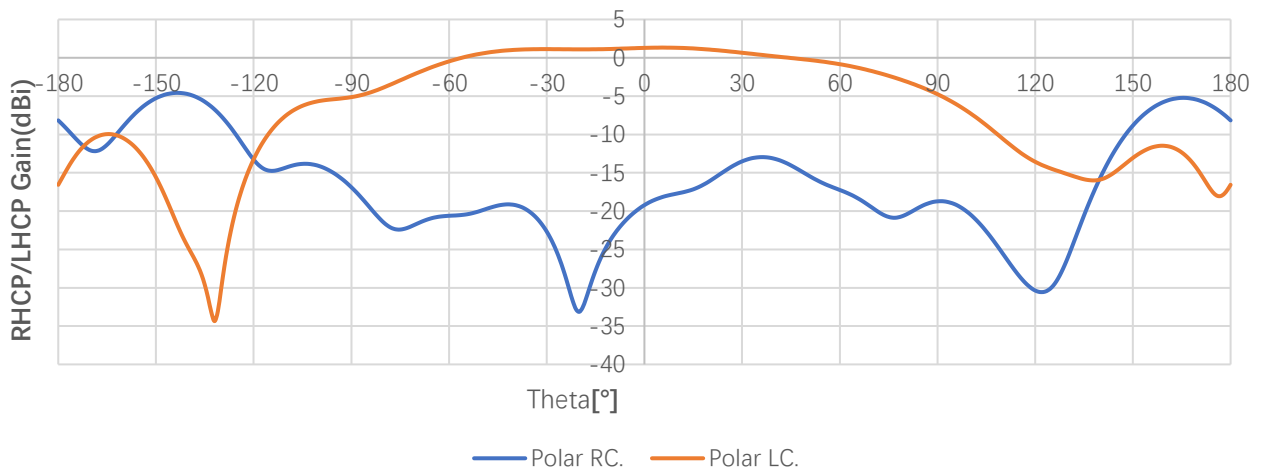

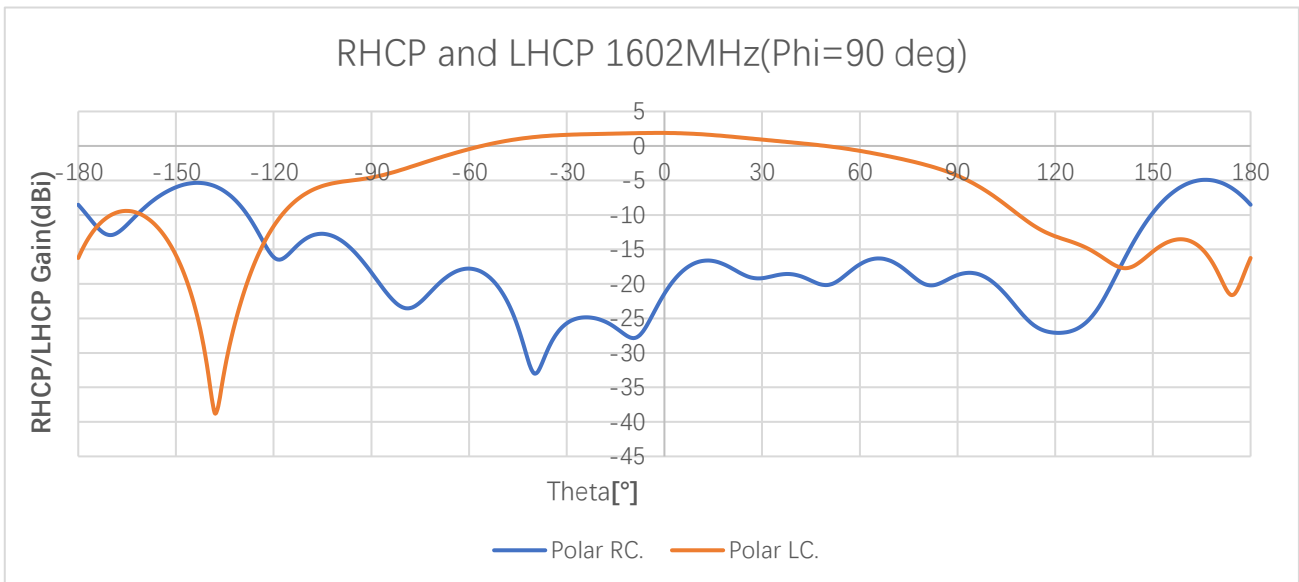
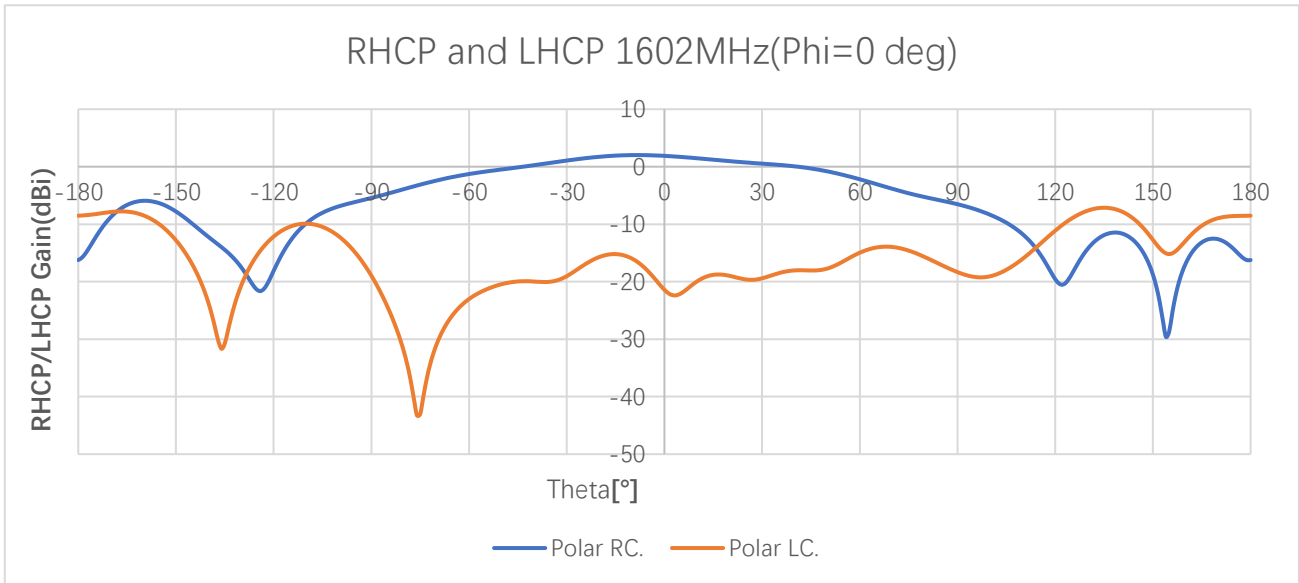

2D RHCP and LHCP Gain (dBi)

| Frequency (MHz) | | 1176 | 1207 | 1227 | 1248 | 1268 | 1561 | 1575 | 1602 |
|--------------------|-----------------------------------|------|------|------|------|------|------|-------|------|
| RHCP Gain (dBi) | Phi = 0 (deg) Theta = 0 (deg) | - | - | - | - | - | 1.8 | 1.83 | 1.76 |
| | Phi = 90 (deg) Theta = 0 (deg) | - | - | - | - | - | 1.8 | 1.83 | 1.76 |
| LHCP Gain (dBi) | Phi = 0 (deg) Theta = 0 (deg) | - | - | - | - | - | -8.5 | -15.4 | -5.9 |
| | Phi = 90 (deg) Theta = 0 (deg) | - | - | - | - | - | -8.5 | -15.4 | -5.9 |

3.2.5. 3D & 2D Radiation Pattern

- Test Condition: on 70 mm x 70 mm PCB
- Test Chamber: GL-S-1

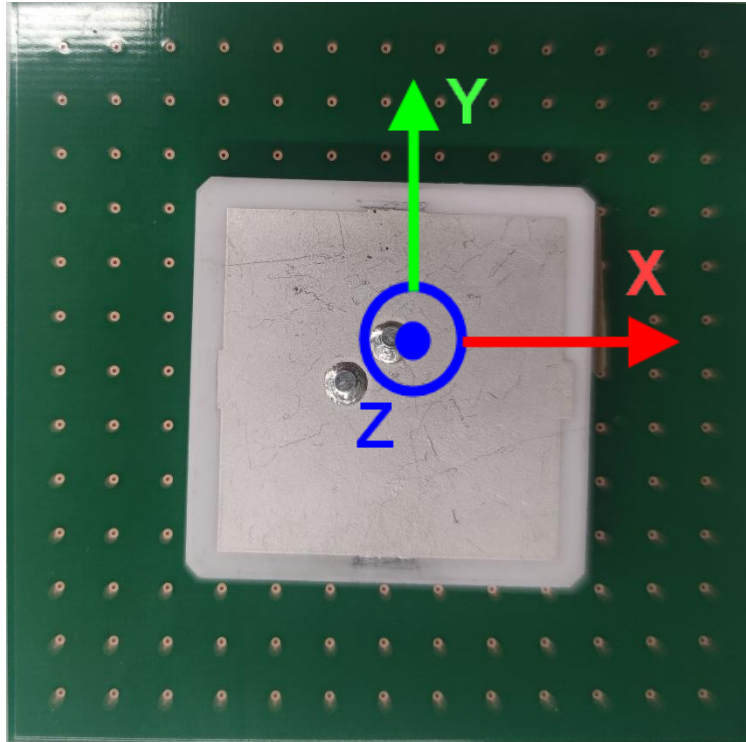

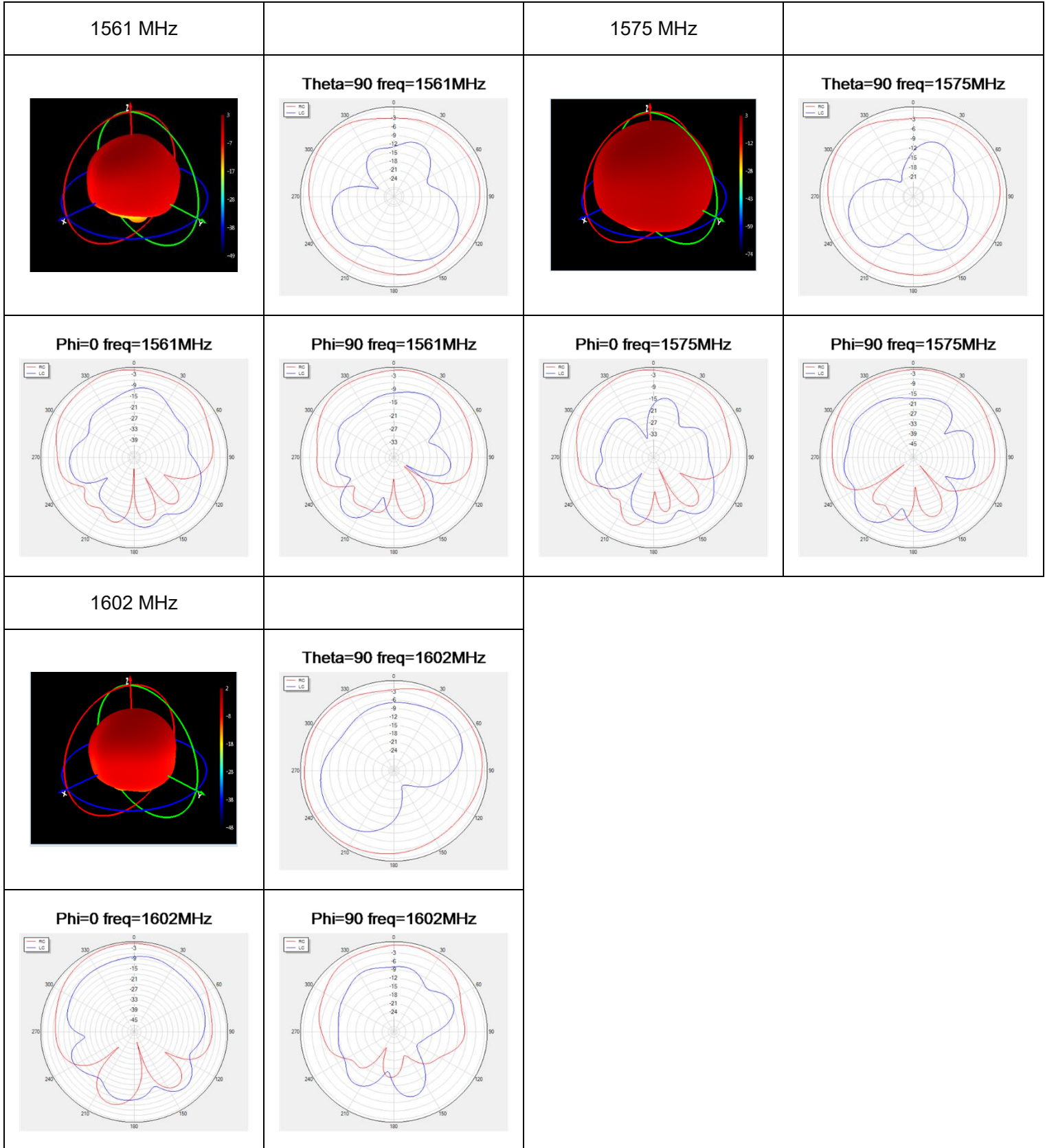

4 PCB Footprint Recommendation

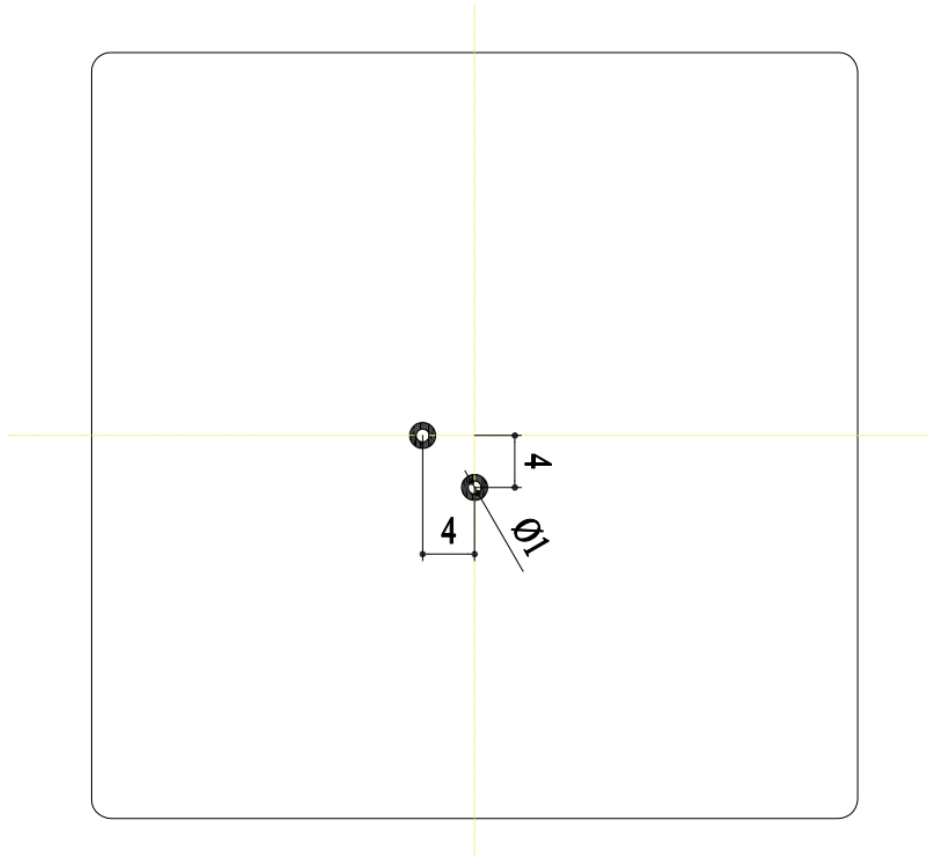

5 Pin Definition

- The pin definition is used to connect the hybrid coupler to ensure Axial Ratio and RHCP.

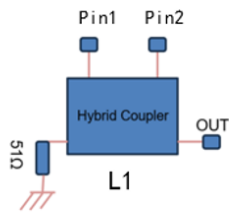

| Antenna Pin | Description |
|-------------|-------------|
| Pin1 | 0° degree |
| Pin2 | -90° degree |

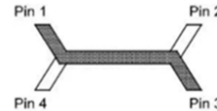

| Configuration | Pin 1 | Pin 2 | Pin 3 | Pin 4 |
|---------------|--------------------------|--------------------------|--------------------------|--------------------------|
| Splitter | Input | Isolated | -3dB $\angle\theta - 90$ | -3dB $\angle\theta$ |
| Splitter | Isolated | Input | -3dB $\angle\theta$ | -3dB $\angle\theta - 90$ |
| Splitter | -3dB $\angle\theta - 90$ | -3dB $\angle\theta$ | Input | Isolated |
| Splitter | -3dB $\angle\theta$ | -3dB $\angle\theta - 90$ | Isolated | Input |
| *Combiner | $A \angle\theta - 90$ | $A \angle\theta$ | Isolated | Output |
| *Combiner | $A \angle\theta$ | $A \angle\theta - 90$ | Output | Isolated |
| *Combiner | Isolated | Output | $A \angle\theta - 90$ | $A \angle\theta$ |
| *Combiner | Output | Isolated | $A \angle\theta$ | $A \angle\theta - 90$ |

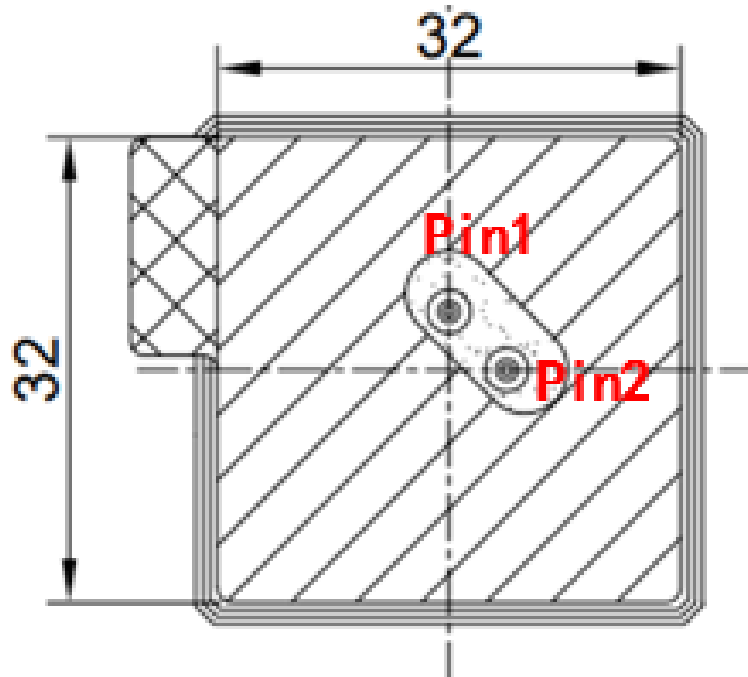

6 Recommended Reflow Soldering Profile

- SOLDER PASTE: Sn/Ag/Cu: 96.5/3.0/0.5
- Recommended reflow condition:

The graphic shows temperature profile for component assembly process in reflow ovens

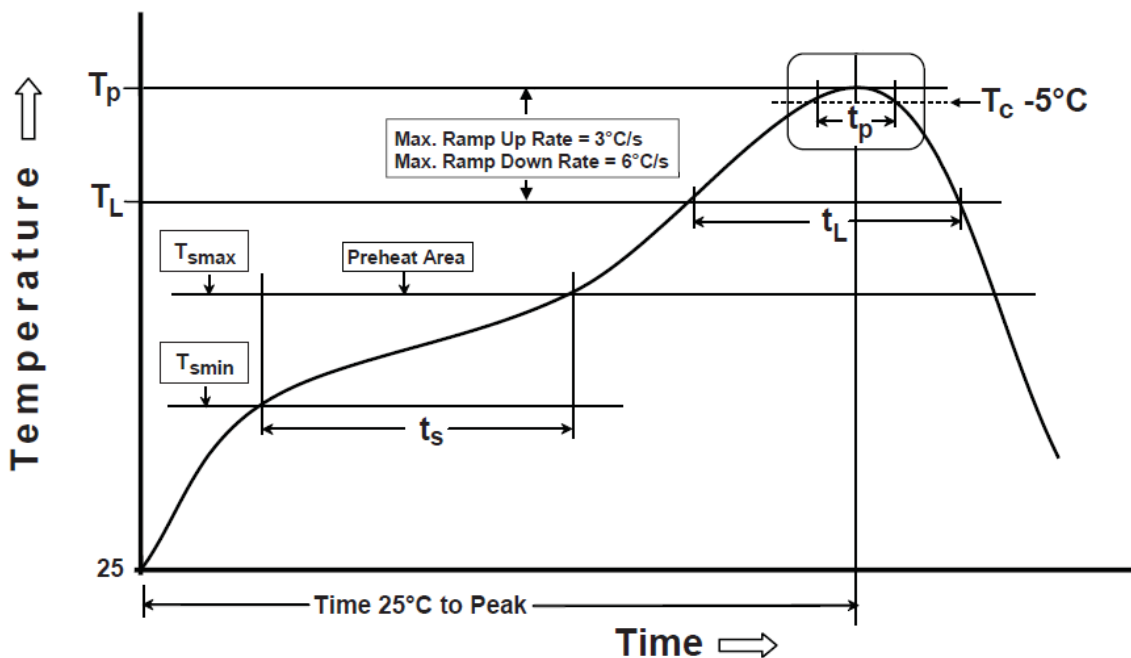

| Phase | Profile Features | Pb-Free Assembly (SnAgCu) |
|-------------------------------------|---|------------------------------------|
| PREHEAT | -Temperature Min (T _{smin}) -Temperature Max (T _{smax}) -Time(t _s) form (T _{smin} to T _{smax}) | 150 °C 200 °C 60–120 seconds |
| RAMP-UP | Avg. Ramp-up Rate (T _{smax} to T _p) | 3 °C /second (max) |
| REFLOW | -Temperature (T _L) -Total Time above T _L (t _L) | 217 °C 30–100 seconds |
| PEAK | -Temperature (T _p) -Time (t _p) | 260 °C 3 second |
| RAMP-DOWN | Rate | 6 °C / second max. |
| Time from 25 °C to Peak Temperature | | 8 minutes max. |

7 Packaging

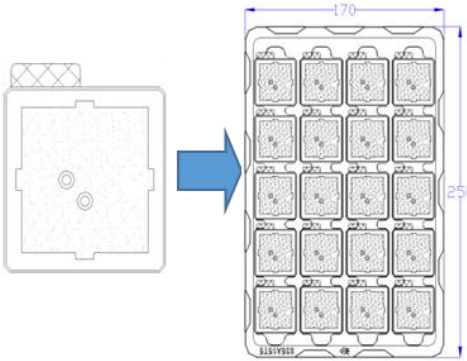
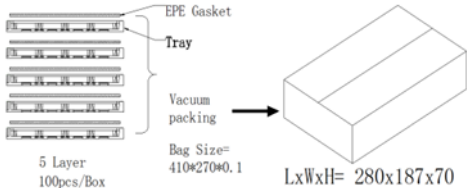
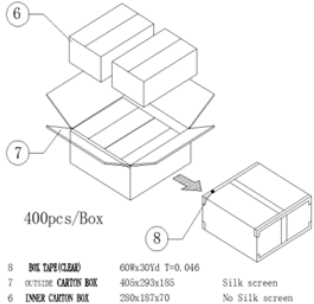
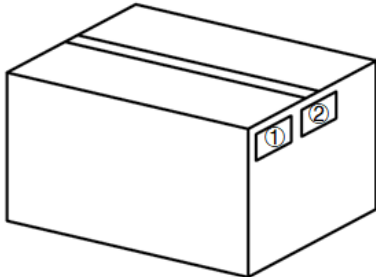
| Step | Packaging Picture / 2D Picture | Description |
|------|---|---|
| 1 |  | (20 PCS Antennas / Tray) |
| 2 |  | The inner box contains 5 plastic trays. (100 PCS Antennas / Inner Box) |
| 3 |  <p>400pcs/Box</p> <p>8 DUX TAPE (3240) 600x301d T=0.046 7 OUTSIDE CARTON BOX 405x293x185 Silk screen 6 INNER CARTON BOX 280x187x70 No Silk screen</p> | (4 Inner Boxes / Carton Box) (400 PCS Antennas / Carton Box) Estimated quantity Products that cannot fill the entire carton box are packed in a suitable size carton box. <u>Carton Size:</u> <u>L × W × H = 405 × 293 × 185 mm</u> |
| 4 |  | <p>Position for Attaching Labels</p> <p>① Carton Label ② Quality Label</p> |

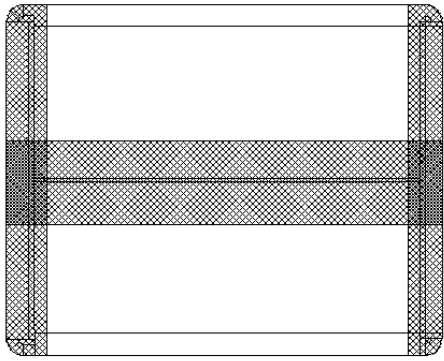
| | | |
|------|--|--|
| 5 |  A technical drawing of an H-shaped sealing carton. It consists of a central horizontal band with a cross-hatched texture, flanked by two vertical bands of the same texture. The bands are connected at the corners to form a rectangular frame. | <p>Sealing Cartons H-shaped sealing cartons</p> |
| Note | <p>The initial packaging method described above is for reference only, and the final actual packaging method shall be subject to the actual shipping packaging.</p> | |

Contact Us

At Quectel, our aim is to provide timely and comprehensive services to our customers. If you require any assistance, please contact our headquarters:

Quectel Wireless Solutions Co., Ltd.

Building 5, Shanghai Business Park Phase III (Area B), No.1016 Tianlin Road, Minhang District, Shanghai 200233, China

Tel: +86 21 5108 6236

Email: info@quectel.com

Or our local offices. For more information, please visit:

<http://www.quectel.com/support/sales.htm>.

For technical support, or to report documentation errors, please visit:

<http://www.quectel.com/support/technical.htm>.

Or email us at: support@quectel.com.

Legal Notices

We offer information as a service to you. The provided information is based on your requirements and we make every effort to ensure its quality. You agree that you are responsible for using independent analysis and evaluation in designing intended products, and we provide reference designs for illustrative purposes only. Before using any hardware, software or service guided by this document, please read this notice carefully. Even though we employ commercially reasonable efforts to provide the best possible experience, you hereby acknowledge and agree that this document and related services hereunder are provided to you on an “as available” basis. We may revise or restate this document from time to time at our sole discretion without any prior notice to you.

Use and Disclosure Restrictions

License Agreements

Documents and information provided by us shall be kept confidential, unless specific permission is granted. They shall not be accessed or used for any purpose except as expressly provided herein.

Copyright

Our and third-party products hereunder may contain copyrighted material. Such copyrighted material shall not be copied, reproduced, distributed, merged, published, translated, or modified without prior written consent. We and the third party have exclusive rights over copyrighted material. No license shall be granted or conveyed under any patents, copyrights, trademarks, or service mark rights. To avoid ambiguities, purchasing in any form cannot be deemed as granting a license other than the normal non-exclusive, royalty-free license to use the material. We reserve the right to take legal action for noncompliance with abovementioned requirements, unauthorized use, or other illegal or malicious use of the material.

Trademarks

Except as otherwise set forth herein, nothing in this document shall be construed as conferring any rights to use any trademark, trade name or name, abbreviation, or counterfeit product thereof owned by Quectel or any third party in advertising, publicity, or other aspects.

Third-Party Rights

This document may refer to hardware, software and/or documentation owned by one or more third parties (“third-party materials”). Use of such third-party materials shall be governed by all restrictions and obligations applicable thereto.

We make no warranty or representation, either express or implied, regarding the third-party materials, including but not limited to any implied or statutory, warranties of merchantability or fitness for a particular purpose, quiet enjoyment, system integration, information accuracy, and non-infringement of any third-party intellectual property rights with regard to the licensed technology or use thereof. Nothing herein constitutes a representation or warranty by us to either develop, enhance, modify, distribute, market, sell, offer for sale, or otherwise maintain production of any our products or any other hardware, software, device, tool, information, or product. We moreover disclaim any and all warranties arising from the course of dealing or usage of trade.

Privacy Policy

To implement module functionality, certain device data are uploaded to Quectel's or third-party's servers, including carriers, chipset suppliers or customer-designated servers. Quectel, strictly abiding by the relevant laws and regulations, shall retain, use, disclose or otherwise process relevant data for the purpose of performing the service only or as permitted by applicable laws. Before data interaction with third parties, please be informed of their privacy and data security policy.

Disclaimer

- a) We acknowledge no liability for any injury or damage arising from the reliance upon the information.
- b) We shall bear no liability resulting from any inaccuracies or omissions, or from the use of the information contained herein.
- c) While we have made every effort to ensure that the functions and features under development are free from errors, it is possible that they could contain errors, inaccuracies, and omissions. Unless otherwise provided by valid agreement, we make no warranties of any kind, either implied or express, and exclude all liability for any loss or damage suffered in connection with the use of features and functions under development, to the maximum extent permitted by law, regardless of whether such loss or damage may have been foreseeable.
- d) We are not responsible for the accessibility, safety, accuracy, availability, legality, or completeness of information, advertising, commercial offers, products, services, and materials on third-party websites and third-party resources.

Copyright © Quectel Wireless Solutions Co., Ltd. 2024. All rights reserved.

Revision History

| Version | Date | Author | Note |
|---------|------------|--|---|
| - | 2024-01-30 | Rhone WEI/ Lucky FENG/ David LIU/ Rainey LIAO | Creation of the document |
| 1.0 | 2024-01-30 | Rhone WEI/ Lucky FENG/ David LIU/ Rainey LIAO | First official release |
| 1.1 | 2024-02-28 | Rhone WEI/ Lucky FENG | 1. Update the drawing (Chapter 2). 2. Added Chapter 5. |
| 1.2 | 2024-03-08 | Rhone WEI/ Lucky FENG | 1. Updated the drawing (Chapter 2). 2. Updated the pin definition drawing (Chapter 5). |
| 1.3 | 2024-12-16 | Lucky FENG | 1. Updated the drawing (Chapter 4). 2. Added Chapter 6. |

QUECTEL

www.quectel.com