

# Antenna Datasheet

**Product OC:** YFCO002AA

**Version:** 2.2

**Date:** 2025-04-16

**Status:** Released

**Product Name:** 5G 2in1 Adhesive Mount Combo Embedded Antenna

**Key Features:**

Frequency Band: 600–6000 MHz

Dimensions: 237 mm × 22 mm

Efficiency: Up to 78.09 % (Right)

RoHS and REACH Compliant

# Overview

To meet customers' requirements for the high performance, high integration, and integrated appearance of their products, Quectel provides a combined internal antenna series. The internal antenna series can integrate a variety of antennas, such as 5G, 4G, GNSS, Wi-Fi antennas, to achieve communication functions of 5G MIMO, 4G, GNSS, and Wi-Fi. These internal antenna series can be mounted inside the devices, supports multiple connector types and cable lengths. It is a more flexible and reliable high-performance antenna solution for the applications need internal antennas.

# Contents

Overview.....	1
Contents.....	2
<b>1 Specification.....</b>	<b>3</b>
1.1. Electrical.....	3
1.2. Mechanical & Environmental .....	5
<b>2 Drawing .....</b>	<b>6</b>
<b>3 Detailed Performance.....</b>	<b>7</b>
3.1. S-Parameter Test .....	7
3.1.1. VSWR.....	7
3.1.2. Return Loss .....	8
3.1.3. Isolation .....	9
3.2. Radiation Performance Test.....	10
3.2.1. Efficiency .....	10
3.2.2. Average Gain .....	11
3.2.3. Peak Gain.....	12
3.2.4. 3D & 2D Radiation Pattern.....	13
<b>4 Packaging .....</b>	<b>22</b>
<b>Contact Us.....</b>	<b>24</b>
<b>Legal Notices .....</b>	<b>25</b>
<b>Revision History .....</b>	<b>27</b>

# 1 Specification

Test Condition: Stick on the 3 mm ABS

## 1.1. Electrical

Electrical	
Frequency Range	600–6000 MHz
Impedance	50 Ω
Polarization	Linear
Radiation Pattern	Omni-directional

Electrical – Detail												
Band	Band	B71	B12	B5	n74	B1	B40	Wi-Fi	B38	B42	n79	Wi-Fi
			/B13	/B8	/n75	/B2		2G	/B41	/B48		5G
Spec	Freq. (MHz)	600–700	700–810	820–960	1420–1520	1700–2170	2300–2400	2400–2500	2500–2690	3300–4200	4400–5000	5150–5850
Max. VSWR	Right	2.0	1.7	1.9	1.4	1.9	1.8	1.7	1.7	1.7	2.4	2.7
	Left	2.0	1.8	1.8	1.3	1.8	1.9	1.7	1.6	1.8	2.4	2.6
Max. Return Loss (dB)	Right	-9.5	-11.9	-10.3	-15.8	-10.1	-10.9	-11.6	-11.5	-11.3	-7.9	-6.7
	Left	-9.4	-11.0	-10.8	-16.7	-10.5	-10.2	-11.5	-12.7	-11.1	-7.7	-7.0
AVG Eff. (%)	Right	40.2	46.7	53.2	70.7	65.5	61.3	56.4	57.2	58.0	44.9	47.4
	Left	41.3	48.0	49.0	72.3	68.2	64.1	61.3	60.8	61.1	47.7	47.3
AVG AVG Gain (dB)	Right	-4.0	-3.3	-2.7	-1.5	-1.8	-2.1	-2.5	-2.4	-2.4	-3.5	-3.3
	Left	-3.8	-3.2	-3.1	-1.4	-1.7	-1.9	-2.1	-2.2	-2.2	-3.2	-3.3
Max. Peak Gain (dBi)	Right	-0.2	2.3	3.0	3.5	4.0	2.8	2.6	2.9	3.9	3.0	5.0
	Left	-0.3	2.4	2.3	2.3	3.5	3.0	2.9	3.9	4.2	3.4	4.8

<b>VSWR</b>	<b>Right</b>	$\leq 2.7$
	<b>Left</b>	$\leq 2.6$
<b>Return Loss</b>	<b>Right</b>	$\leq -6.7$ dB
	<b>Left</b>	$\leq -7.0$ dB
<b>Peak Gain</b>	<b>Right</b>	$\leq 5.0$ dBi
	<b>Left</b>	$\leq 4.8$ dBi

- Antenna placement

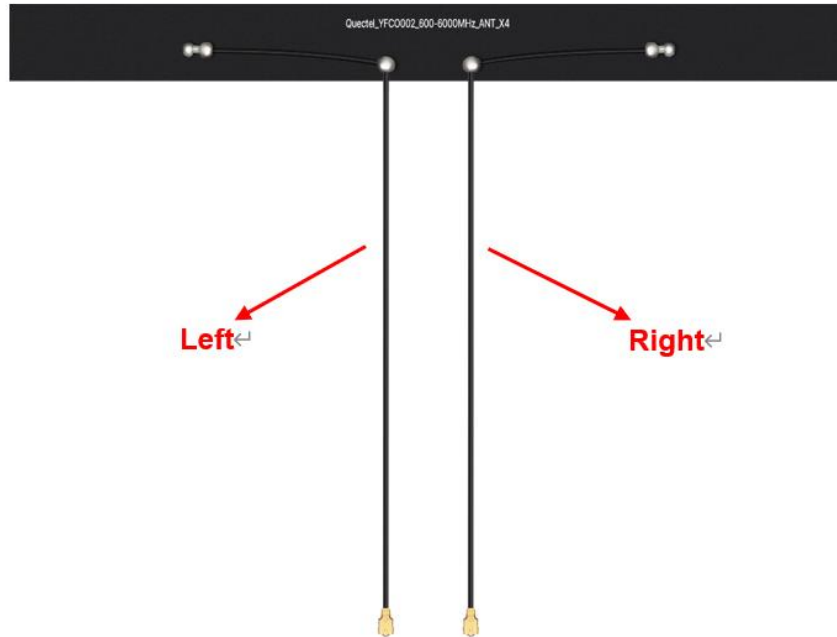

## 1.2. Mechanical & Environmental

Mechanical	
Antenna Dimensions	237 mm × 22 mm
Antenna Material & Color	FPC & Black
Cable Type & Color & Length	Φ 1.13 & Black & 150 mm
Connector Type	IPEX MHF 1
Mounting Type	Adhesive
Weight	Typ. 3.1 g
Environmental	
Operation Temperature	-40 °C to +85 °C
Storage Temperature	-40 °C to +85 °C
RoHS and REACH Compliant	Yes

# 2 Drawing

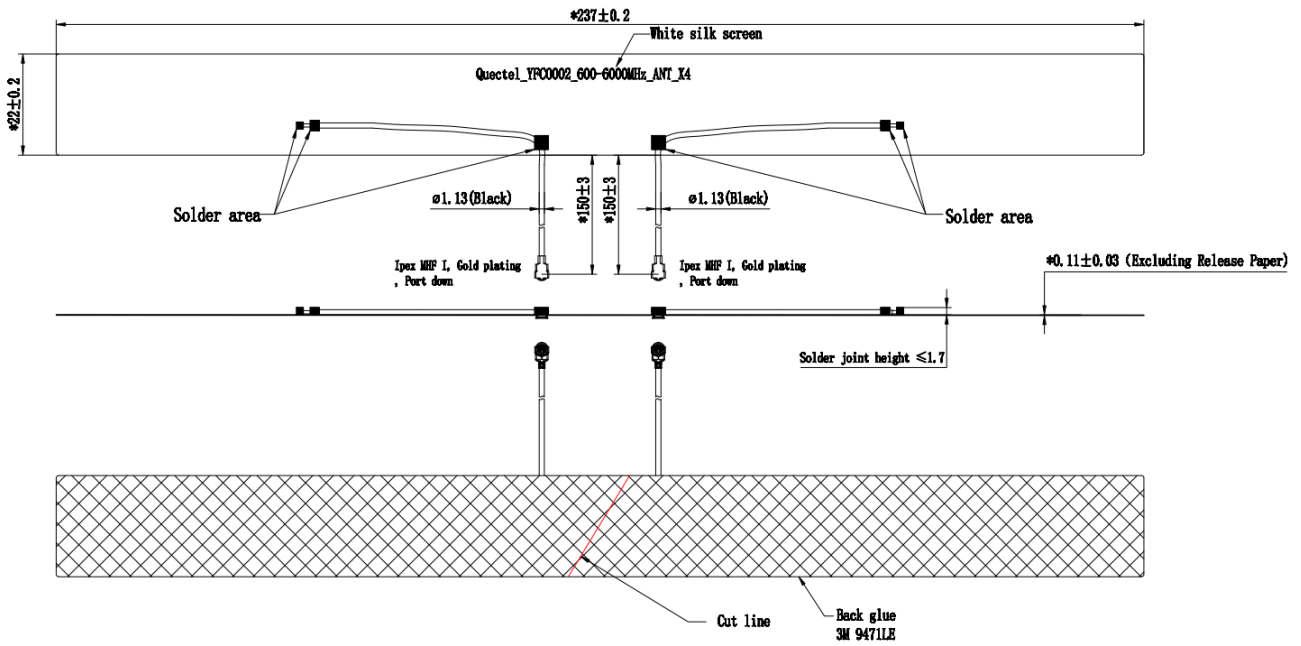

# 3 Detailed Performance

## 3.1. S-Parameter Test

### 3.1.1. VSWR

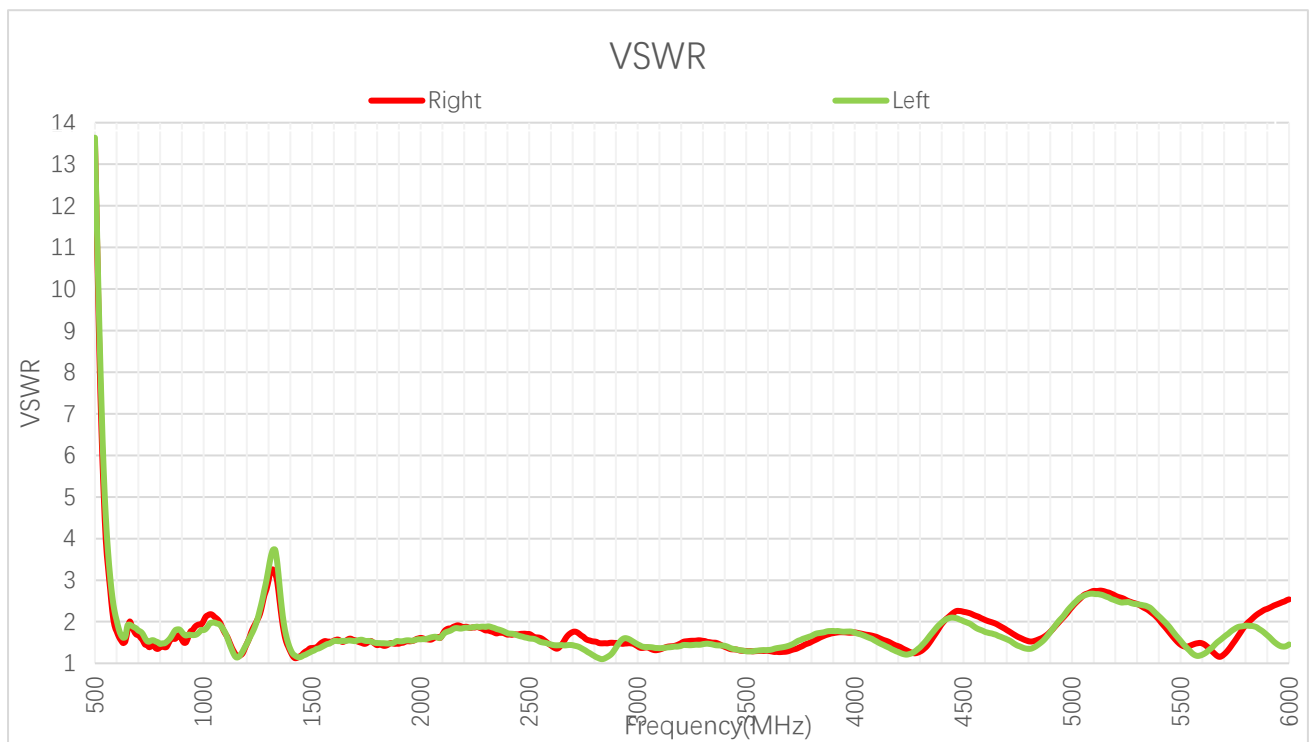

**VSWR**

Frequency (MHz)	600	630	710	830	900	960	1440	1710	1740	1880
Right	1.8	1.5	1.6	1.4	1.6	1.9	1.2	1.5	1.5	1.5
Left	2.0	1.6	1.8	1.5	1.8	1.7	1.1	1.6	1.5	1.5
Frequency (MHz)	1950	2140	2350	2450	2600	2690	4700	5000	5500	6000
Right	1.5	1.8	1.7	1.7	1.4	1.7	1.8	2.4	1.5	2.5
Left	1.5	1.8	1.8	1.7	1.5	1.4	1.6	2.4	1.5	1.5

**3.1.2. Return Loss**

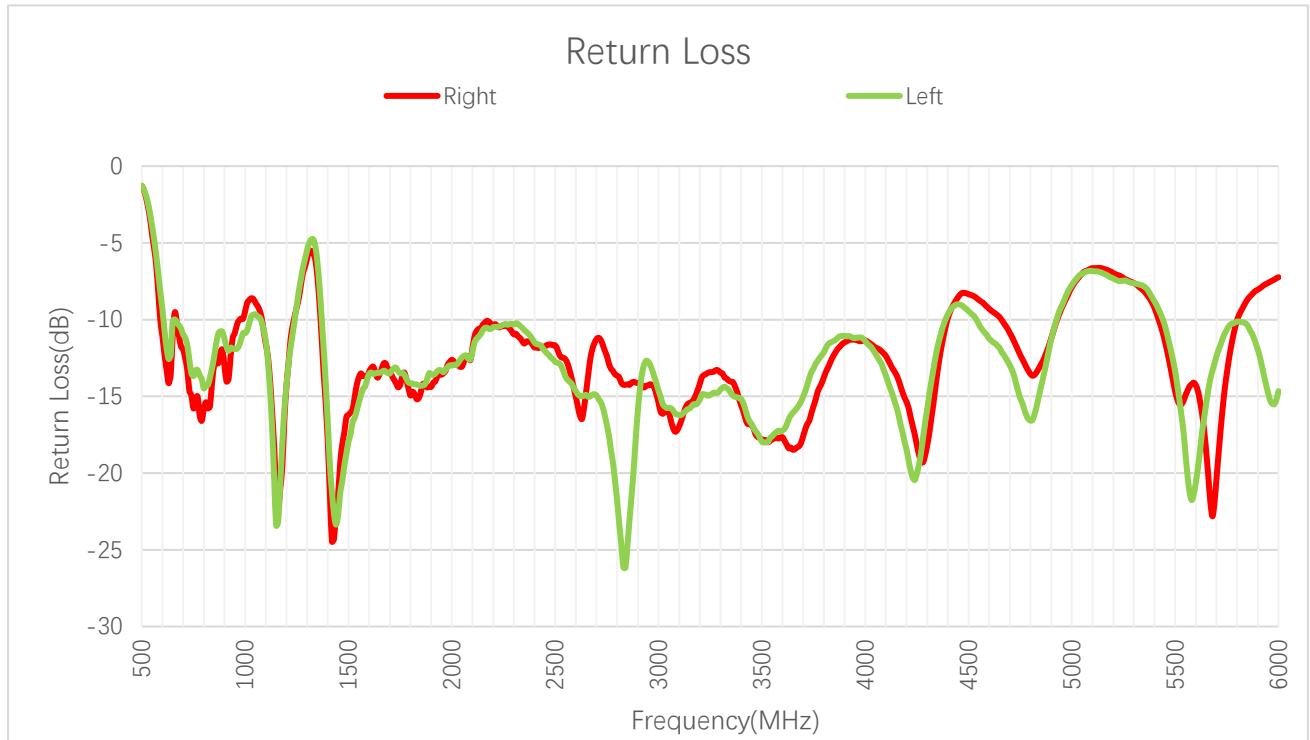

**Return Loss (dB)**

Frequency (MHz)	600	630	710	830	900	960	1440	1710	1740	1880
<b>Right</b>	-11.1	-14.2	-12.5	-15.6	-13.0	-10.3	-22.5	-13.7	-14.4	-14.4
<b>Left</b>	-9.4	-12.6	-11.2	-13.8	-11.3	-11.9	-23.4	-13.3	-13.4	-13.9
Frequency (MHz)	1950	2140	2350	2450	2600	2690	4700	5000	5500	6000
<b>Right</b>	-13.6	-10.6	-11.6	-11.8	-15.0	-11.5	-10.9	-7.9	-14.7	-7.2
<b>Left</b>	-13.3	-10.9	-10.7	-12.0	-14.7	-14.9	-13.0	-7.7	-13.4	-14.7

**3.1.3. Isolation**

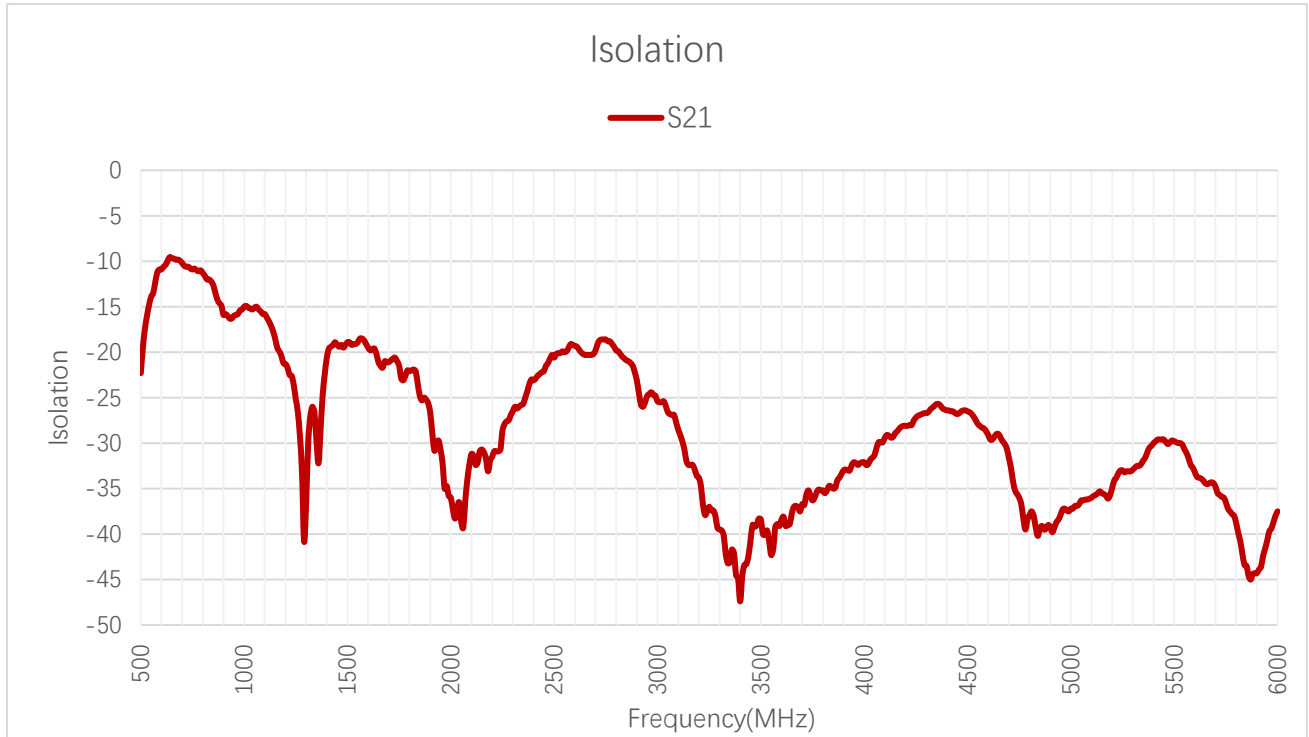

**Isolation**

<b>Frequency (MHz)</b>	<b>600</b>	<b>630</b>	<b>710</b>	<b>830</b>	<b>900</b>	<b>960</b>	<b>1440</b>	<b>1710</b>	<b>1740</b>	<b>1880</b>
<b>Isolation (dB)</b>	-10.5	-9.9	-10.5	-12.0	-15.9	-15.9	-18.9	-20.9	-21.0	-25.2
<b>Frequency (MHz)</b>	<b>1950</b>	<b>2140</b>	<b>2350</b>	<b>2450</b>	<b>2600</b>	<b>2690</b>	<b>4700</b>	<b>5000</b>	<b>5500</b>	<b>6000</b>
<b>Isolation (dB)</b>	-30.7	-30.9	-25.7	-22.1	-19.3	-20.2	-31.6	-37.2	-29.8	-37.5

### 3.2. Radiation Performance Test

#### 3.2.1. Efficiency

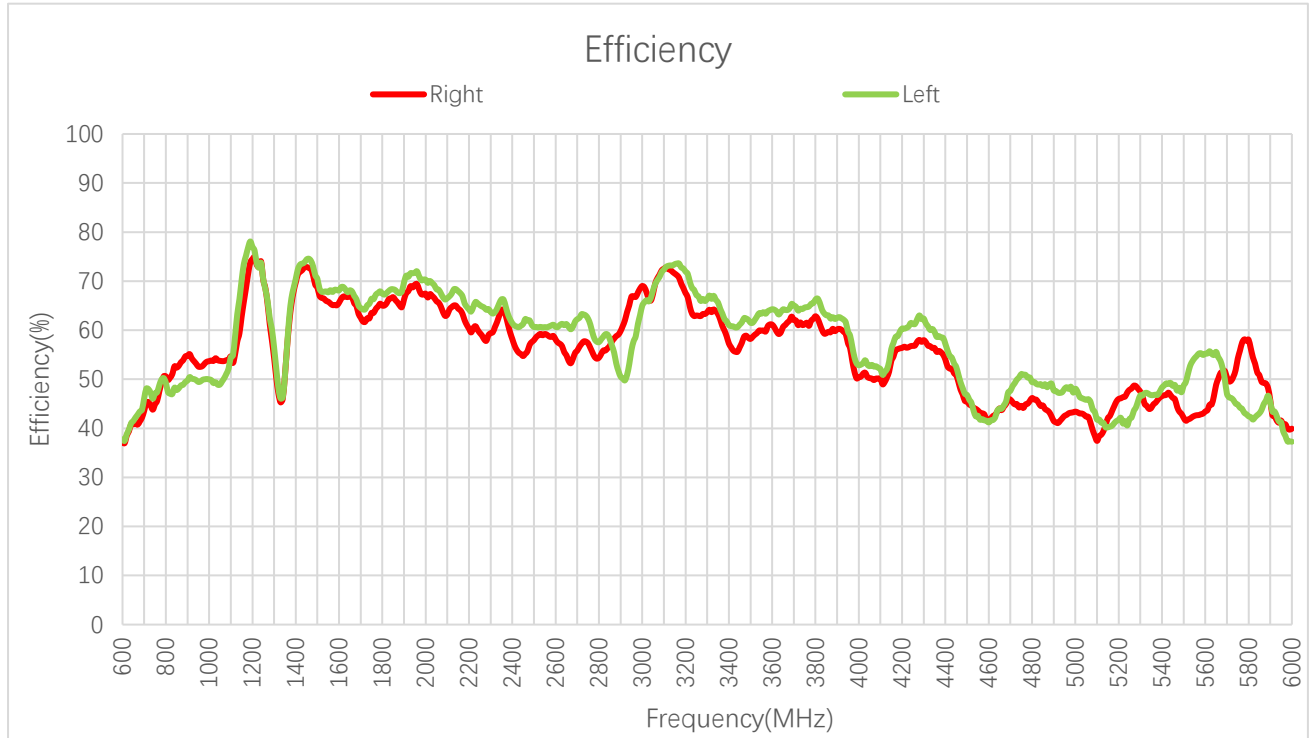

**Efficiency (%)**

Frequency (MHz)	600	630	710	830	900	960	1440	1710	1740	1880
Right	37.1	39.4	45.2	51.1	54.8	52.5	72.8	61.8	62.4	65.0
Left	37.8	39.8	48.1	47.0	49.7	49.6	73.8	64.3	65.4	67.6
Frequency (MHz)	1950	2140	2350	2450	2600	2690	4700	5000	5500	6000
Right	69.3	65.0	64.1	54.7	58.1	55.4	45.9	43.4	42.2	39.9
Left	71.7	68.4	66.3	61.3	60.7	61.8	47.6	48.1	48.7	37.3

**3.2.2. Average Gain**

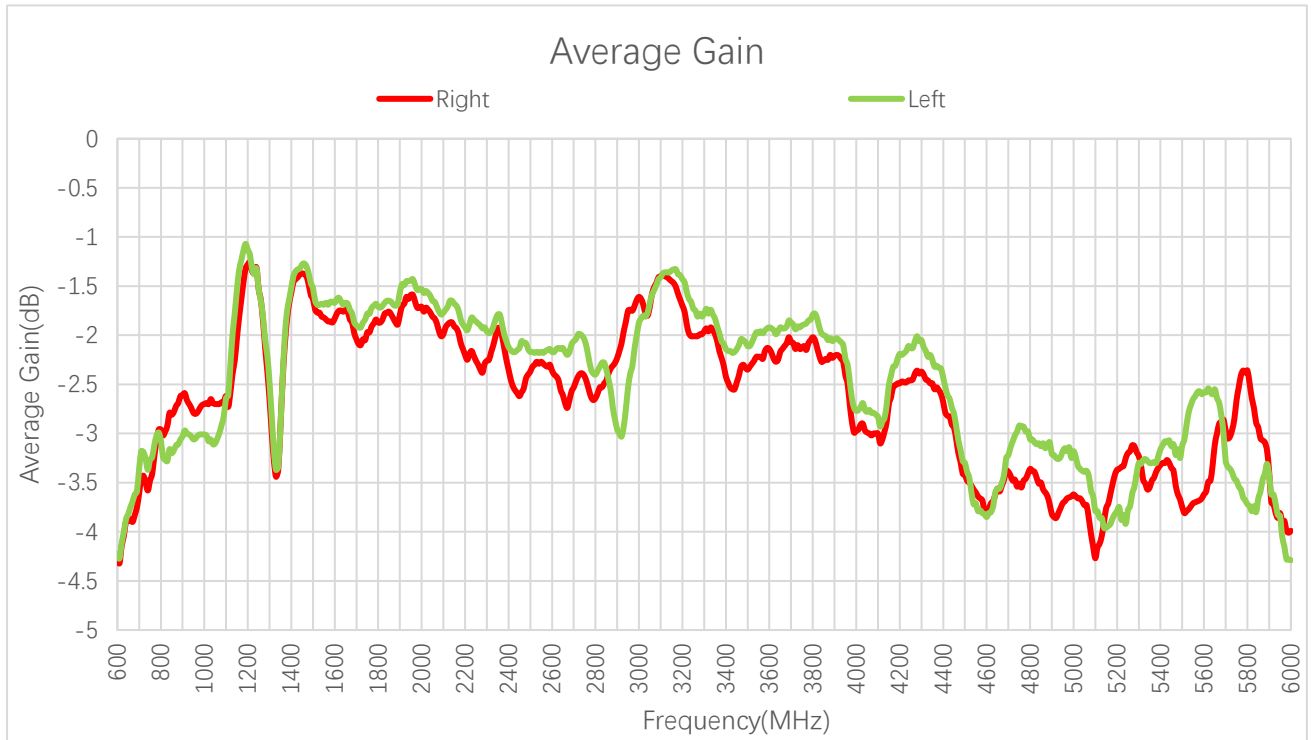

**Average Gain (dB)**

<b>Frequency (MHz)</b>	<b>600</b>	<b>630</b>	<b>710</b>	<b>830</b>	<b>900</b>	<b>960</b>	<b>1440</b>	<b>1710</b>	<b>1740</b>	<b>1880</b>
<b>Right</b>	-4.3	-4.0	-3.5	-2.9	-2.6	-2.8	-1.4	-2.1	-2.1	-1.9
<b>Left</b>	-4.2	-4.0	-3.2	-3.3	-3.0	-3.1	-1.3	-1.9	-1.8	-1.7
<b>Frequency (MHz)</b>	<b>1950</b>	<b>2140</b>	<b>2350</b>	<b>2450</b>	<b>2600</b>	<b>2690</b>	<b>4700</b>	<b>5000</b>	<b>5500</b>	<b>6000</b>
<b>Right</b>	-1.6	-1.9	-1.9	-2.6	-2.4	-2.6	-3.4	-3.6	-3.8	-4.0
<b>Left</b>	-1.4	-1.7	-1.8	-2.1	-2.2	-2.1	-3.2	-3.2	-3.1	-4.3

**3.2.3. Peak Gain**

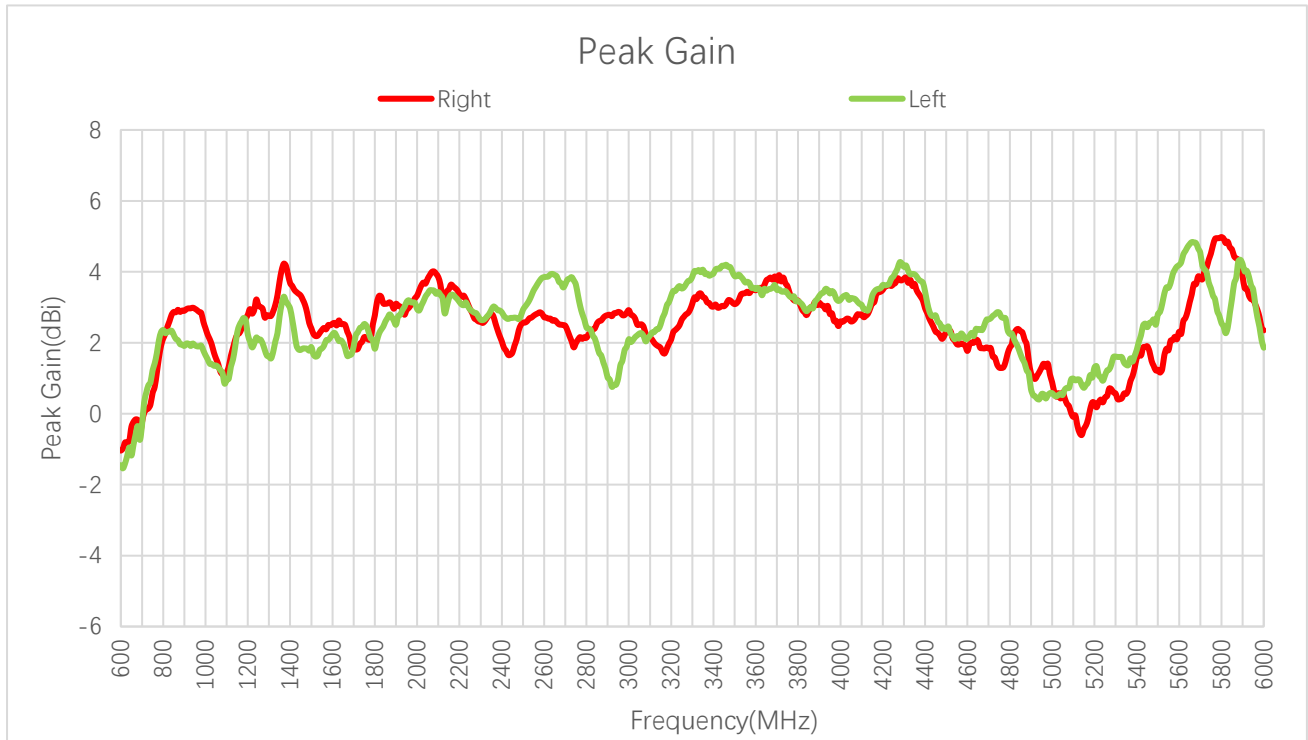

**Peak Gain (dBi)**

<b>Frequency (MHz)</b>	<b>600</b>	<b>630</b>	<b>710</b>	<b>830</b>	<b>900</b>	<b>960</b>	<b>1440</b>	<b>1710</b>	<b>1740</b>	<b>1880</b>
<b>Right</b>	-1.0	-0.8	0.0	2.6	2.9	2.9	3.4	1.8	2.0	3.1
<b>Left</b>	-1.5	-1.2	0.3	2.3	1.9	1.9	1.8	2.2	2.4	2.7
<b>Frequency (MHz)</b>	<b>1950</b>	<b>2140</b>	<b>2350</b>	<b>2450</b>	<b>2600</b>	<b>2690</b>	<b>4700</b>	<b>5000</b>	<b>5500</b>	<b>6000</b>
<b>Right</b>	2.9	3.4	2.8	1.7	2.7	2.5	1.8	0.9	1.2	2.4
<b>Left</b>	3.2	3.0	2.9	2.7	3.9	3.6	2.7	0.6	2.8	1.9

### 3.2.4. 3D & 2D Radiation Pattern

- Test Condition: Stick on the 3 mm ABS
- Test Chamber: GL-S-1

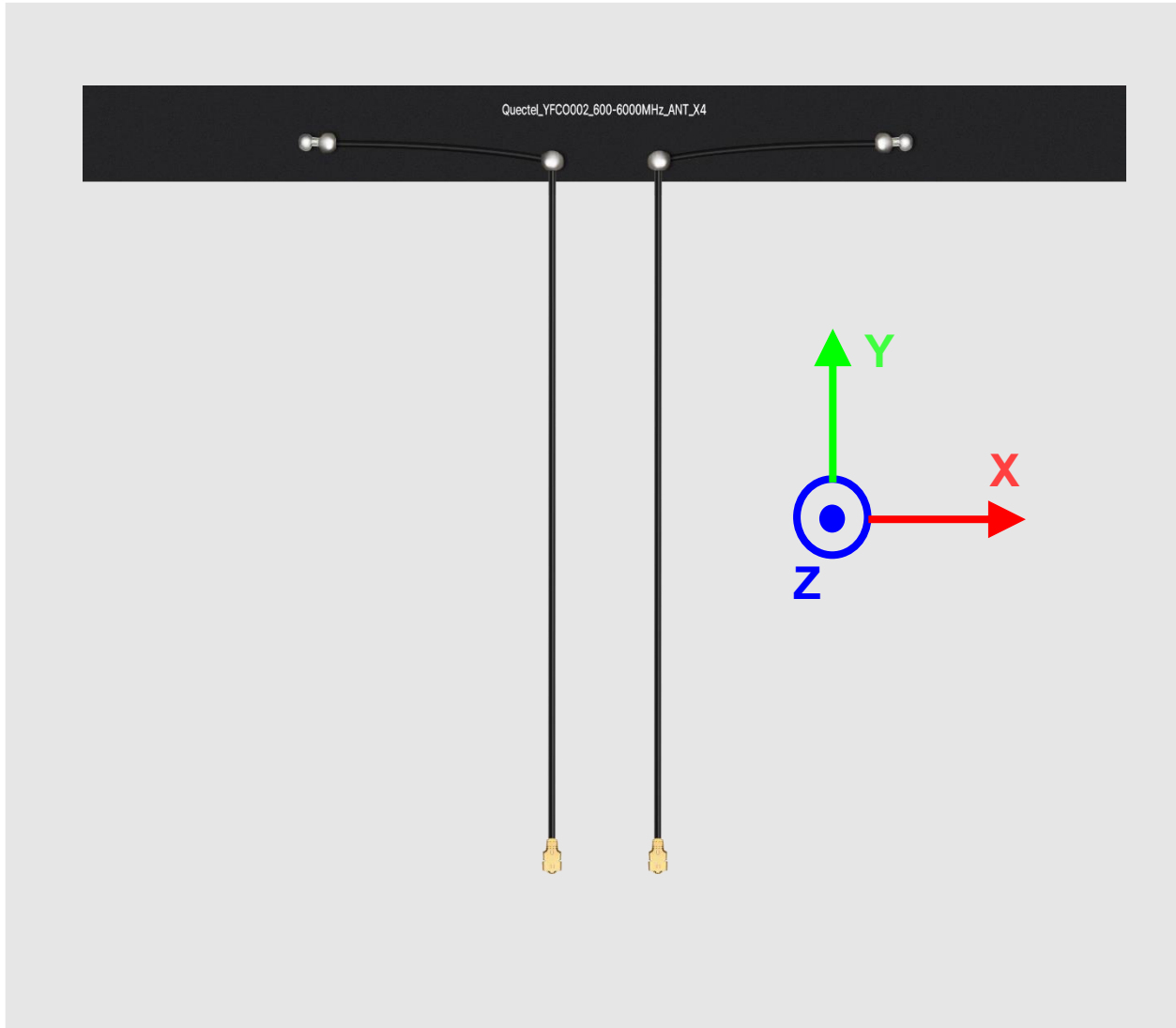

● **Right**

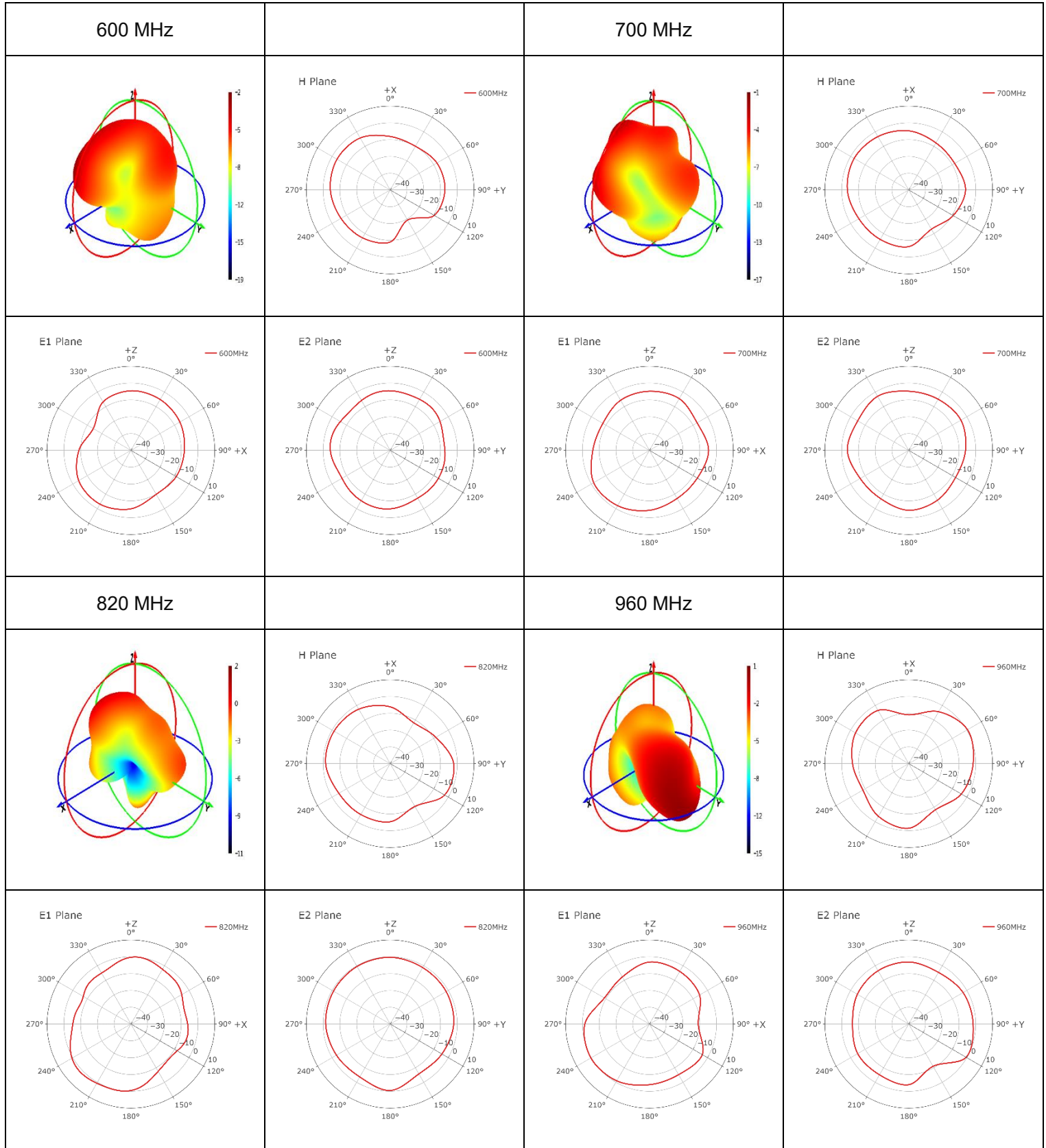

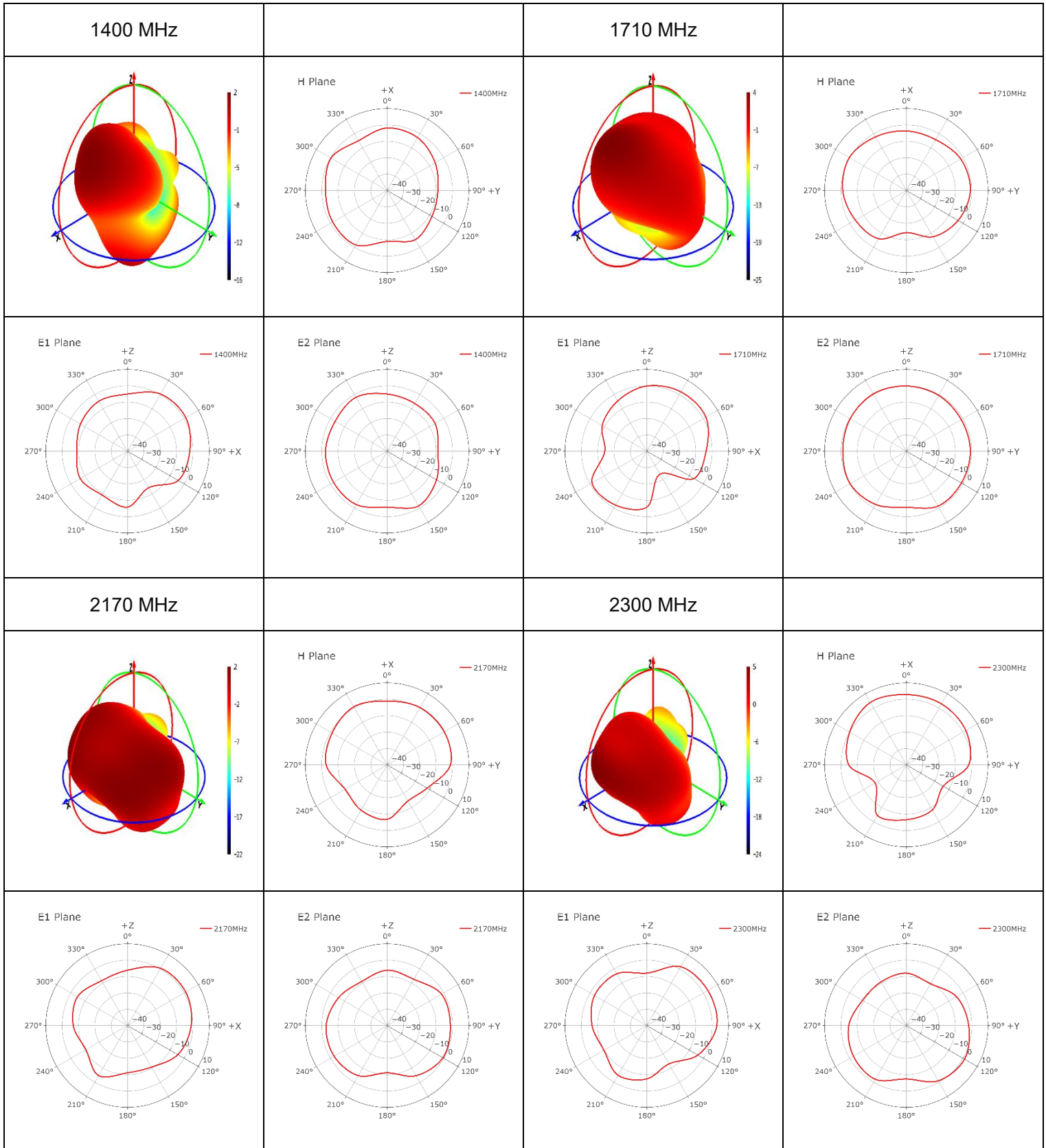

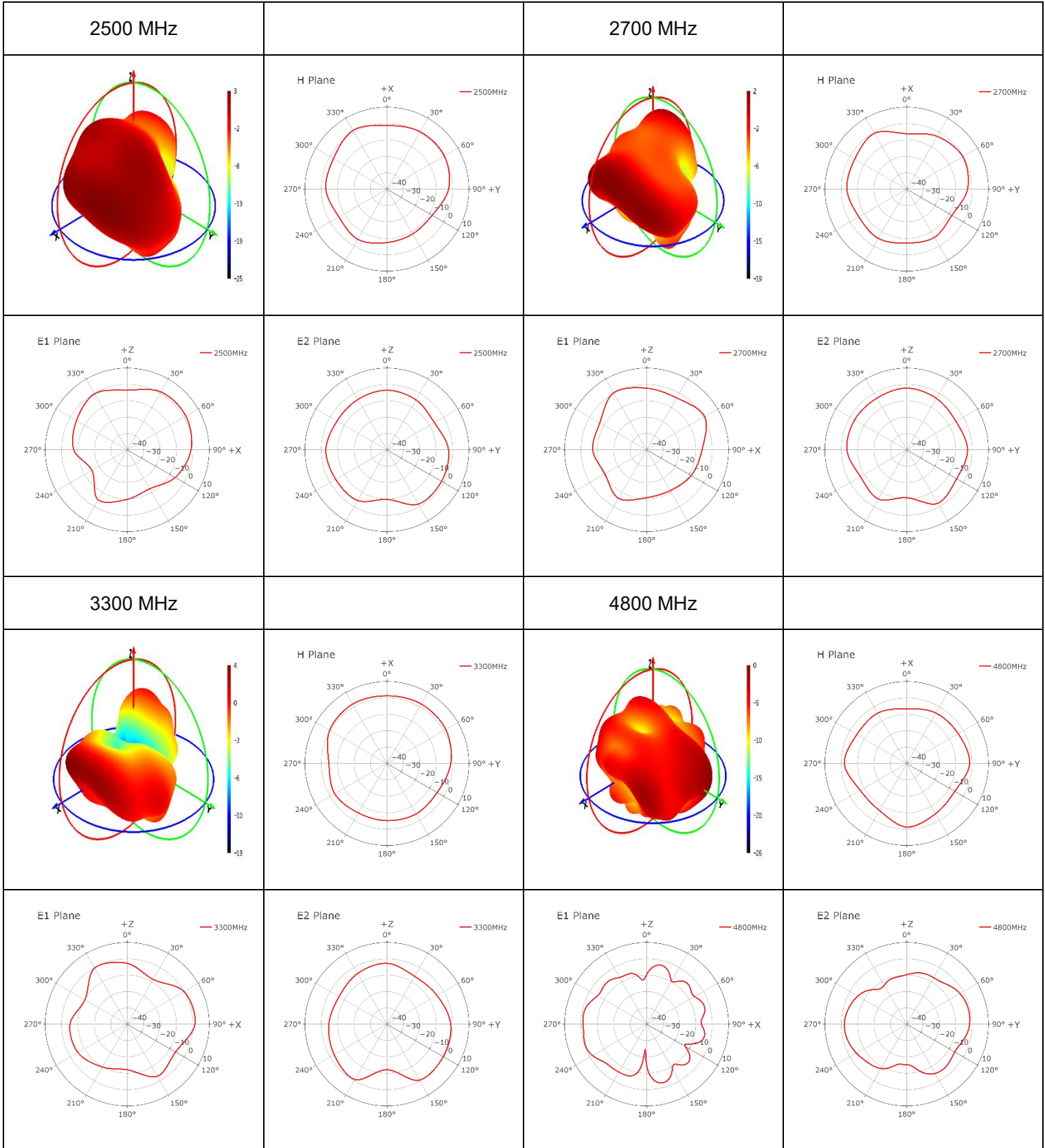

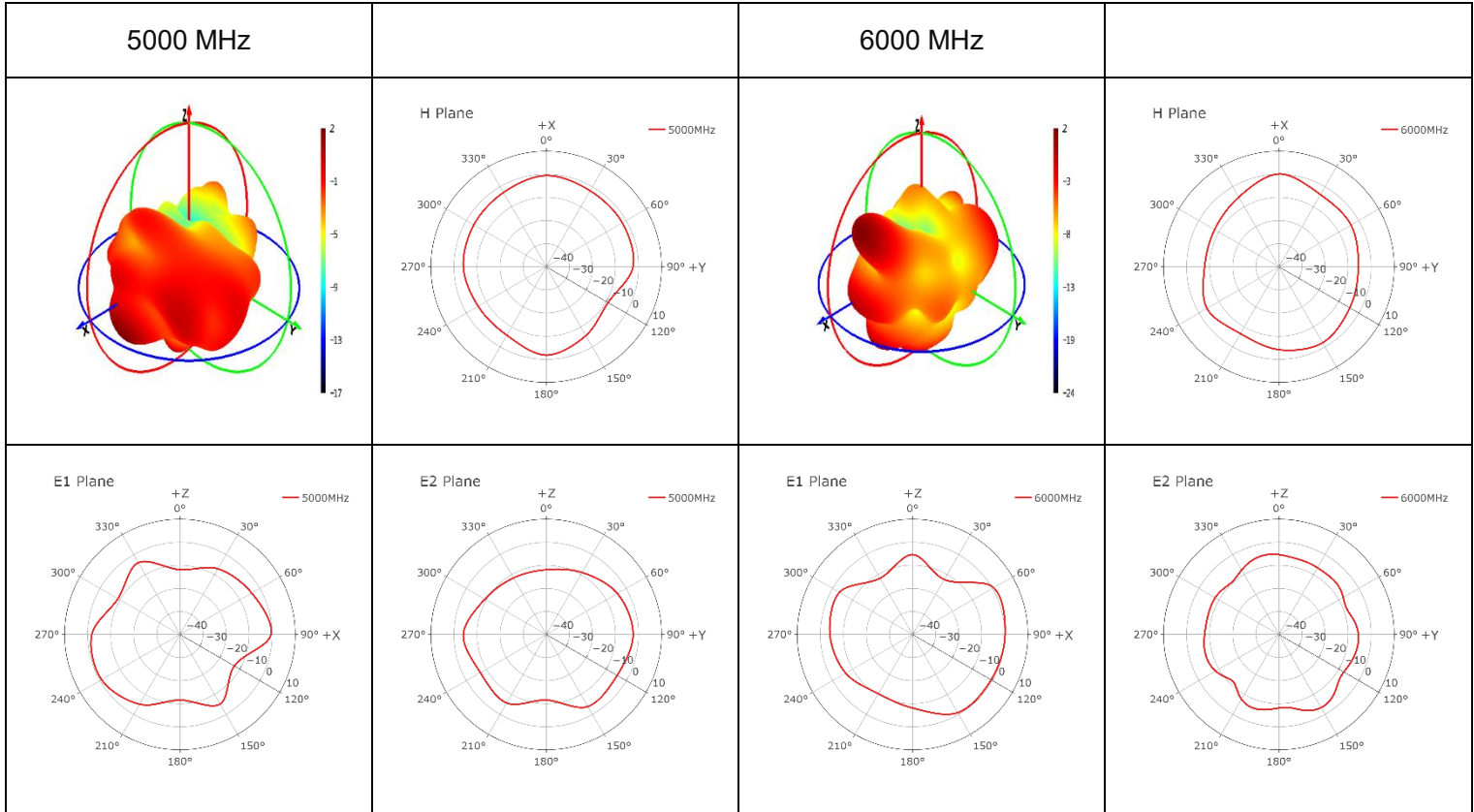

● **Left**

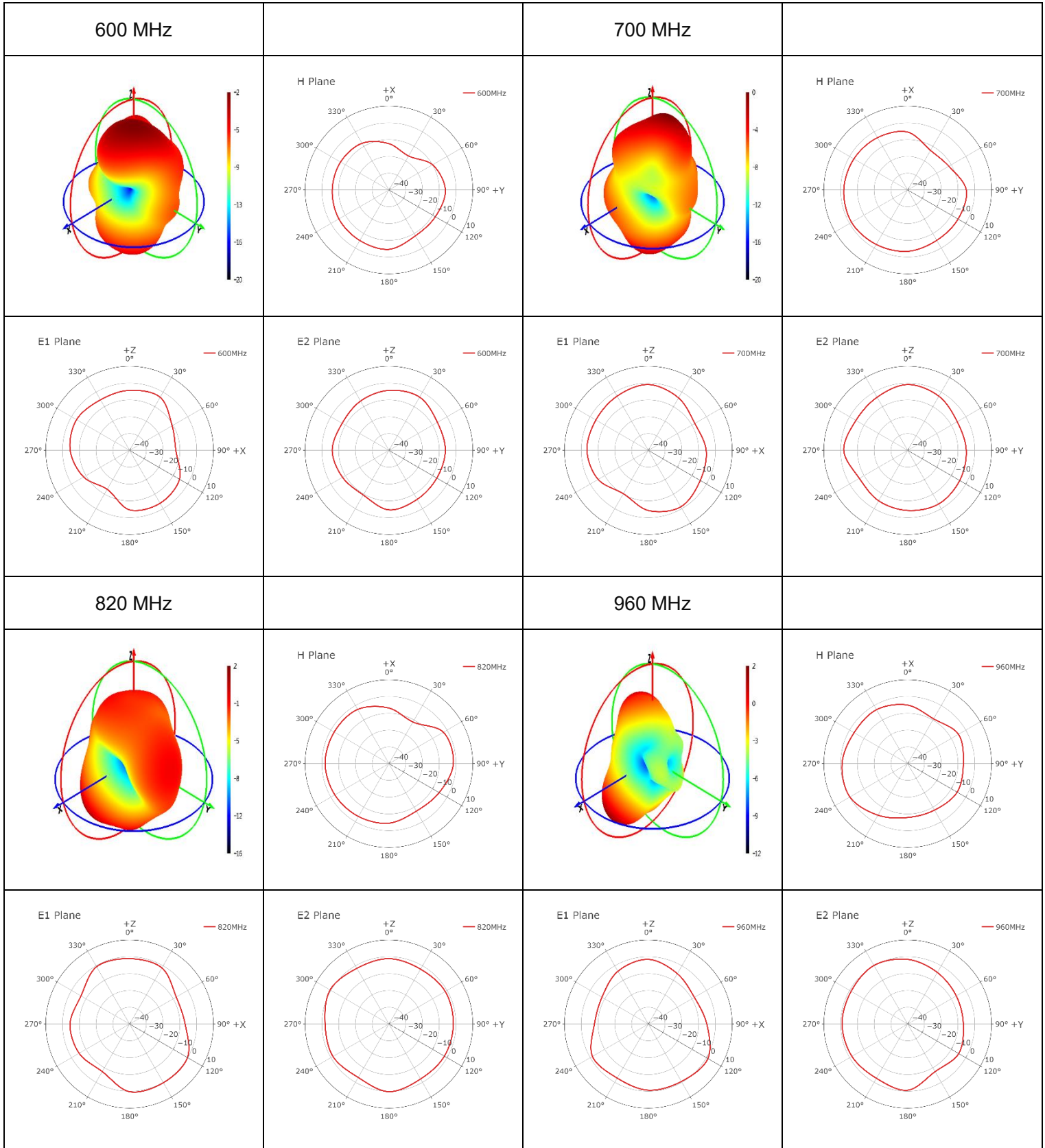

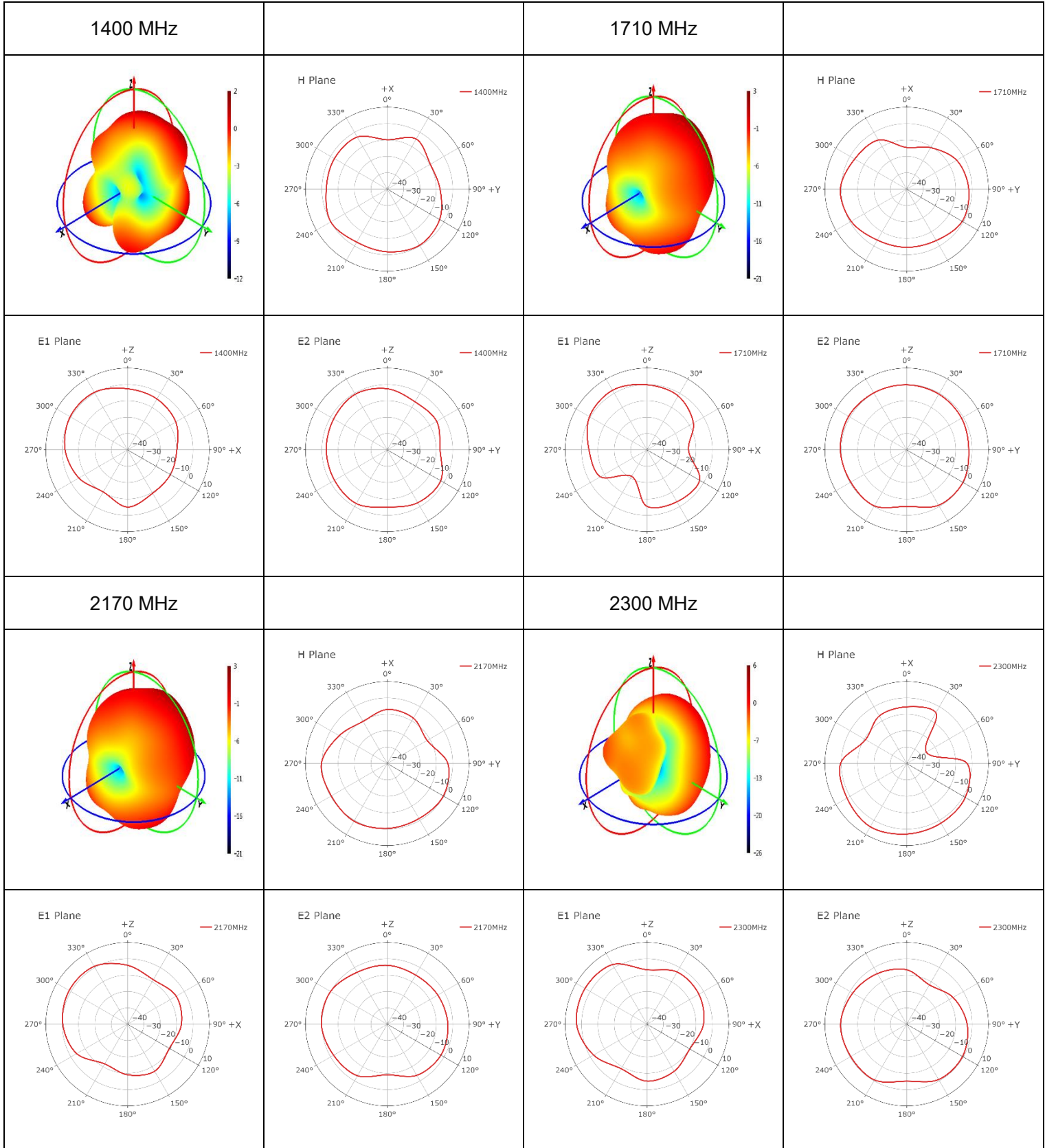

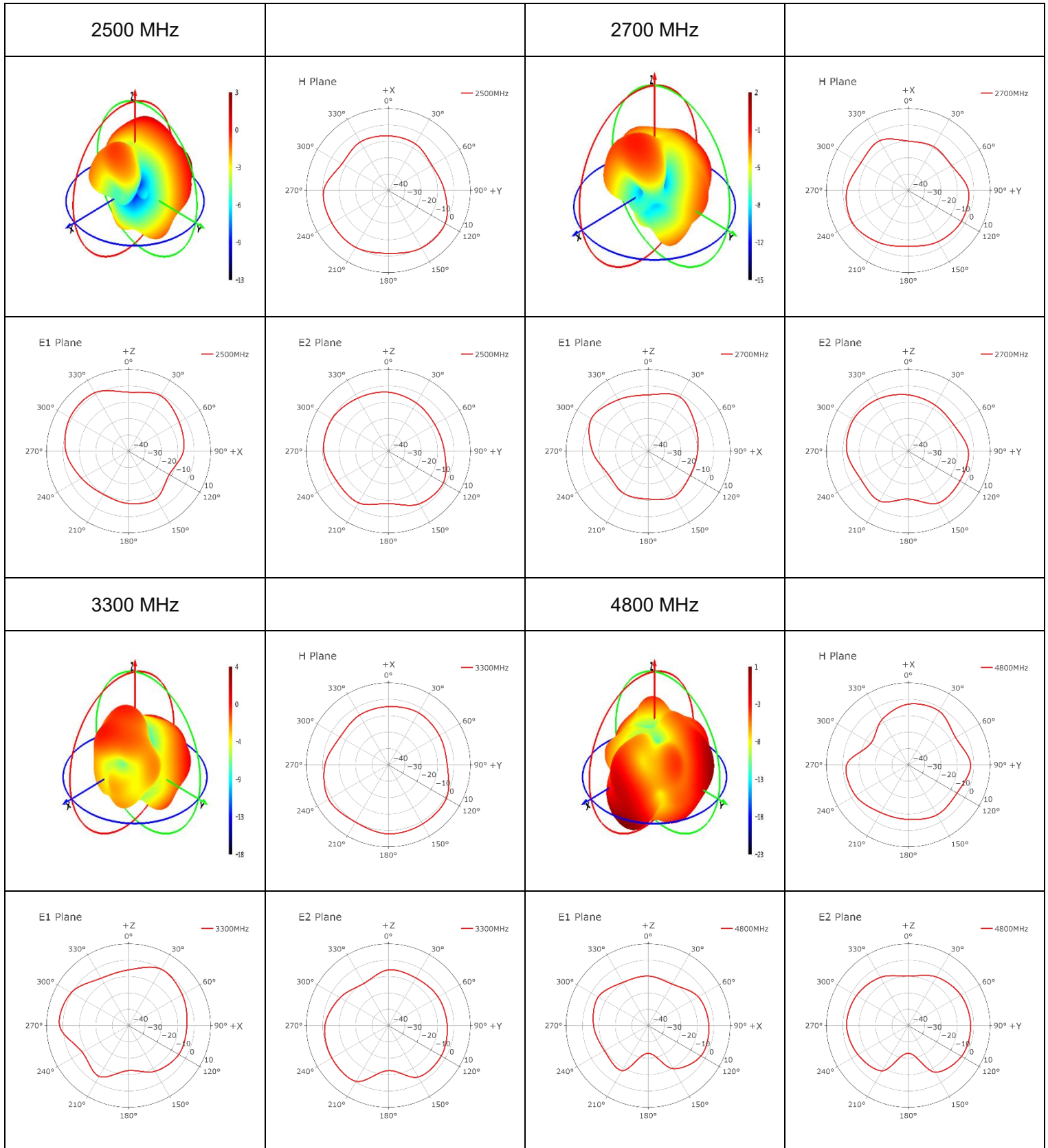

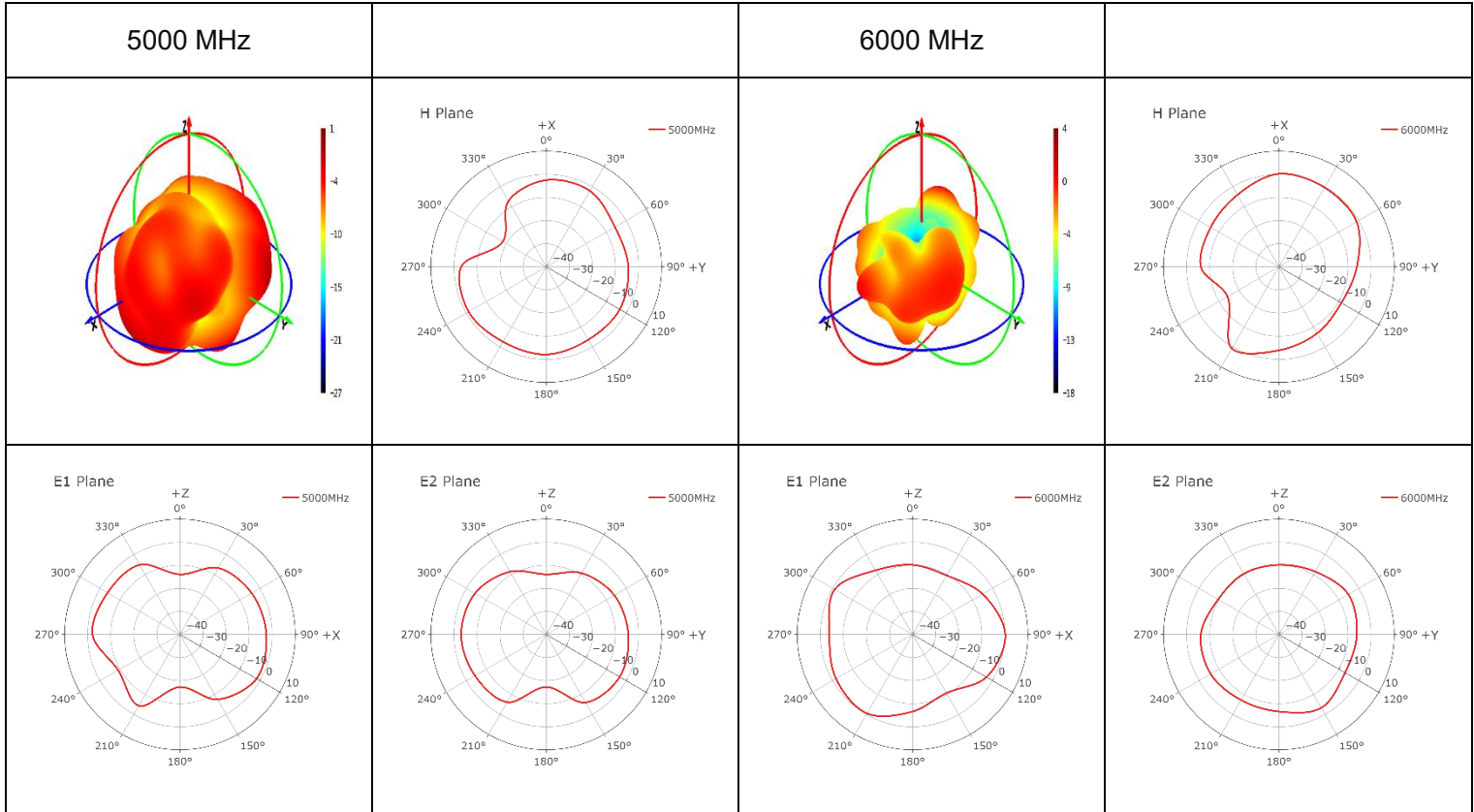

# 4 Packaging

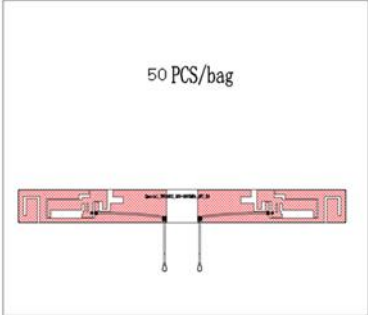
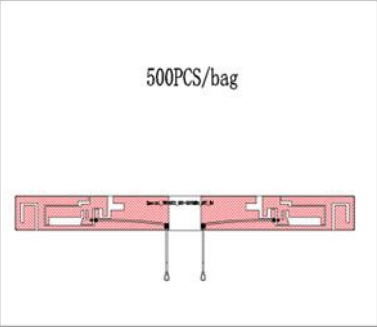
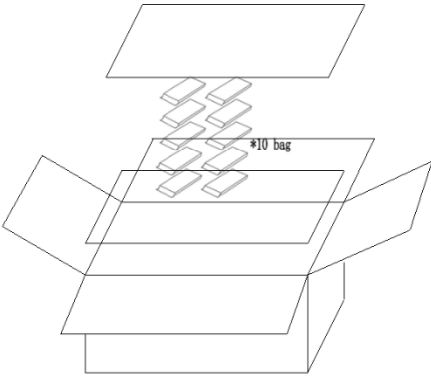
Step	Packaging Picture / 2D Picture	Description
1		<p>50 antenna products in a small PE bag. (50 PCS / Small PE Bag)</p>
2		<p>500 antenna products in a big PE bag. (500 PCS / Big PE Bag)</p>
3		<p>(10 PE Bags / Carton Box) (5000 PCS / Carton Box) Estimated quantity</p> <p>Products that cannot fill the entire carton box are packed in a suitable size carton box.</p> <p><u>Carton Size:</u> <u>L × W × H = 300 × 250 × 200 mm</u></p>

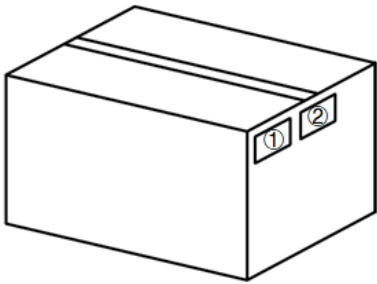
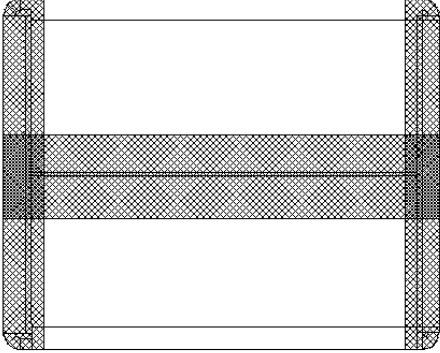
<p>4</p>		<p><b>Position for Attaching Labels</b></p> <ul style="list-style-type: none"> <li>① Carton Label</li> <li>② Quality Label</li> </ul>
<p>5</p>		<p><b>Sealing Cartons</b> H-shaped sealing cartons</p>
<p>Note</p>	<p>The initial packaging method described above is for reference only, and the final actual packaging method shall be subject to the actual shipping packaging.</p>	

# Contact Us

**At Quectel, our aim is to provide timely and comprehensive services to our customers. If you require any assistance, please contact our headquarters:**

**Quectel Wireless Solutions Co., Ltd.**

Building 5, Shanghai Business Park Phase III (Area B), No.1016 Tianlin Road, Minhang District, Shanghai 200233, China

Tel: +86 21 5108 6236

Email: [info@quectel.com](mailto:info@quectel.com)

**Or our local offices. For more information, please visit:**

<http://www.quectel.com/support/sales.htm>.

**For technical support, or to report documentation errors, please visit:**

<http://www.quectel.com/support/technical.htm>.

Or email us at: [support@quectel.com](mailto:support@quectel.com).

# Legal Notices

We offer information as a service to you. The provided information is based on your requirements and we make every effort to ensure its quality. You agree that you are responsible for using independent analysis and evaluation in designing intended products, and we provide reference designs for illustrative purposes only. Before using any hardware, software or service guided by this document, please read this notice carefully. Even though we employ commercially reasonable efforts to provide the best possible experience, you hereby acknowledge and agree that this document and related services hereunder are provided to you on an “as available” basis. We may revise or restate this document from time to time at our sole discretion without any prior notice to you.

## Use and Disclosure Restrictions

### License Agreements

Documents and information provided by us shall be kept confidential, unless specific permission is granted. They shall not be accessed or used for any purpose except as expressly provided herein.

### Copyright

Our and third-party products hereunder may contain copyrighted material. Such copyrighted material shall not be copied, reproduced, distributed, merged, published, translated, or modified without prior written consent. We and the third party have exclusive rights over copyrighted material. No license shall be granted or conveyed under any patents, copyrights, trademarks, or service mark rights. To avoid ambiguities, purchasing in any form cannot be deemed as granting a license other than the normal non-exclusive, royalty-free license to use the material. We reserve the right to take legal action for noncompliance with abovementioned requirements, unauthorized use, or other illegal or malicious use of the material.

### Trademarks

Except as otherwise set forth herein, nothing in this document shall be construed as conferring any rights to use any trademark, trade name or name, abbreviation, or counterfeit product thereof owned by Quectel or any third party in advertising, publicity, or other aspects.

### Third-Party Rights

This document may refer to hardware, software and/or documentation owned by one or more third parties (“third-party materials”). Use of such third-party materials shall be governed by all restrictions and obligations applicable thereto.

We make no warranty or representation, either express or implied, regarding the third-party materials, including but not limited to any implied or statutory, warranties of merchantability or fitness for a particular purpose, quiet enjoyment, system integration, information accuracy, and non-infringement of any third-party intellectual property rights with regard to the licensed technology or use thereof. Nothing herein constitutes a representation or warranty by us to either develop, enhance, modify, distribute, market, sell, offer for sale, or otherwise maintain production of any our products or any other hardware, software, device, tool, information, or product. We moreover disclaim any and all warranties arising from the course of dealing or usage of trade.

## Privacy Policy

To implement module functionality, certain device data are uploaded to Quectel's or third-party's servers, including carriers, chipset suppliers or customer-designated servers. Quectel, strictly abiding by the relevant laws and regulations, shall retain, use, disclose or otherwise process relevant data for the purpose of performing the service only or as permitted by applicable laws. Before data interaction with third parties, please be informed of their privacy and data security policy.

## Disclaimer

- a) We acknowledge no liability for any injury or damage arising from the reliance upon the information.
- b) We shall bear no liability resulting from any inaccuracies or omissions, or from the use of the information contained herein.
- c) While we have made every effort to ensure that the functions and features under development are free from errors, it is possible that they could contain errors, inaccuracies, and omissions. Unless otherwise provided by valid agreement, we make no warranties of any kind, either implied or express, and exclude all liability for any loss or damage suffered in connection with the use of features and functions under development, to the maximum extent permitted by law, regardless of whether such loss or damage may have been foreseeable.
- d) We are not responsible for the accessibility, safety, accuracy, availability, legality, or completeness of information, advertising, commercial offers, products, services, and materials on third-party websites and third-party resources.

**Copyright © Quectel Wireless Solutions Co., Ltd. 2025. All rights reserved.**

# Revision History

Version	Date	Author	Note
	2021-12-17	Eleven Long Jason Long	Creation of the document
1.0	2021-12-17	Eleven Long Jason Long	First official release
1.1	2022-01-12	Eleven Long Jason Long	Updated to IPEX MHF original terminal and added the antenna weight parameter (Chapter 3).
2.0	2024-06-27	Jaden Feng/ Hart HU/ David LIU/ Aria CHU	<ol style="list-style-type: none"><li>1. Updated test data in this datasheet.</li><li>2. Updated the drawing (Chapter 2).</li></ol>
2.1	2024-10-31	Jason LONG	Updated the cable length (Chapter 1.2).
2.2	2025-04-16	Aria CHU	Updated the antenna image (Cover page).

**QUECTEL**

[www.quectel.com](http://www.quectel.com)