

Antenna Datasheet

Product OC: YF0017FA

Version: 2.2

Date: 2025-04-16

Status: Released

Product Name: 5G Adhesive Mount FPC + Cable Dipole Embedded
Antenna

Key Features:

Frequency Band: 1500–6000 MHz

Dimensions: 49 mm × 13 mm

Efficiency: Up to 77.8 % (EVB)

RoHS and REACH Compliant

Overview

This Quectel embedded 5G FPC antenna covers 5G NR Sub-6 GHz frequency bands and is compatible with 4G/3G/2G/LPWA bands. Ground plane independent, it's designed to be mounted directly to the underside of either a plastic or non-metallic enclosure. Ease of integration with a cable and connector which can be customized to meet your product design and RF module. Used with other 5G antennas, it can achieve MIMO (multiple input, multiple output) antenna technology for wireless communications in which multiple antennas are used at both the source (transmitter) and the destination (receiver).

Contents

Overview.....	1
Contents.....	2
1 Specification.....	3
1.1. Electrical.....	3
1.2. Mechanical & Environmental	4
2 Drawing	5
3 Detailed Performance.....	6
3.1. S-Parameter Test	6
3.1.1. VSWR.....	6
3.1.2. Return Loss	7
3.2. Radiation Performance Test.....	8
3.2.1. Efficiency	8
3.2.2. Average Gain	9
3.2.3. Peak Gain.....	10
3.2.4. 3D & 2D Radiation Pattern.....	11
3.2.4.1. Test Condition: Stick to ABS Board on 130 mm × 130 mm EVB Board	11
3.2.4.2. Test Condition: Free Space	15
4 Packaging	19
Contact Us.....	21
Legal Notices	22
Revision History	24

1 Specification

Test Condition: Stick to ABS board on 130 mm × 130 mm EVB board & Free space

1.1. Electrical

Electrical	
Frequency Range	1500–6000 MHz
Impedance	50 Ω
Polarization	Linear
Radiation Pattern	Omni-directional

Electrical – Detail												
Band	Band	B71	B12 /B13 /B28	B5 /B8 /B26	B1 /B2 /B3	B40	Wi-Fi 2G	B38 /B41	B48	B42 /n77	n79	Wi-Fi 5G
	SPEC	Freq. (MHz)	600– 700	700– 810	820– 960	1700– 2170	2300– 2400	2400– 2500	2500– 2690	3550– 3700	3300– 4200	4400– 5000
Max. VSWR	EVB	-	-	-	1.8	2.0	2.1	1.8	1.9	2.5	2.2	1.7
	FS	-	-	-	2.5	1.3	2.0	2.0	1.9	1.9	2.5	2.1
Max. Return Loss (dB)	EVB	-	-	-	-10.9	-9.8	-9.1	-11.1	-10.0	-7.2	-8.6	-12.1
	FS	-	-	-	-7.5	-16.6	-9.8	-9.8	-10.2	-10.0	-7.4	-9.3
AVG Eff. (%)	EVB	-	-	-	62.2	62.9	45.8	63.2	74.8	61.1	45.8	52.3
	FS	-	-	-	56.7	71.3	69.0	67.1	56.7	60.1	63.9	64.2
AVG AVG Gain (dB)	EVB	-	-	-	-2.1	-2.1	-3.4	-2.0	-1.3	-2.2	-3.4	-2.8
	FS	-	-	-	-2.5	-1.5	-1.6	-1.7	-2.5	-2.2	-1.9	-1.9
Max. Peak	EVB	-	-	-	4.4	4.1	3.7	3.3	5.5	5.5	3.9	2.8

Gain (dBi)	FS	-	-	-	2.3	3.0	2.9	3.5	3.4	4.0	4.4	3.9
VSWR	EVB		≤ 2.5									
	FS		≤ 2.5									
Return Loss	EVB		≤ -7.2 dB									
	FS		≤ -7.4 dB									
Peak Gain	EVB		≤ 5.5 dBi									
	FS		≤ 4.4 dBi									

- FS: Free Space
- EVB: Stick to ABS board on 130 mm × 130 mm EVB board

1.2. Mechanical & Environmental

Mechanical	
Antenna Dimensions	49 mm × 13 mm
Material & Color	FPC & Black
Cable Type & Color & Length	Φ 1.13 & Black & 201 mm
Connector Type	IPEX MHF 4L
Mounting Type	Adhesive
Weight	Typ. 0.9 g
Environmental	
Operation Temperature	-40 °C to +85 °C
Storage Temperature	-40 °C to +85 °C
RoHS and REACH Compliant	Yes

2 Drawing

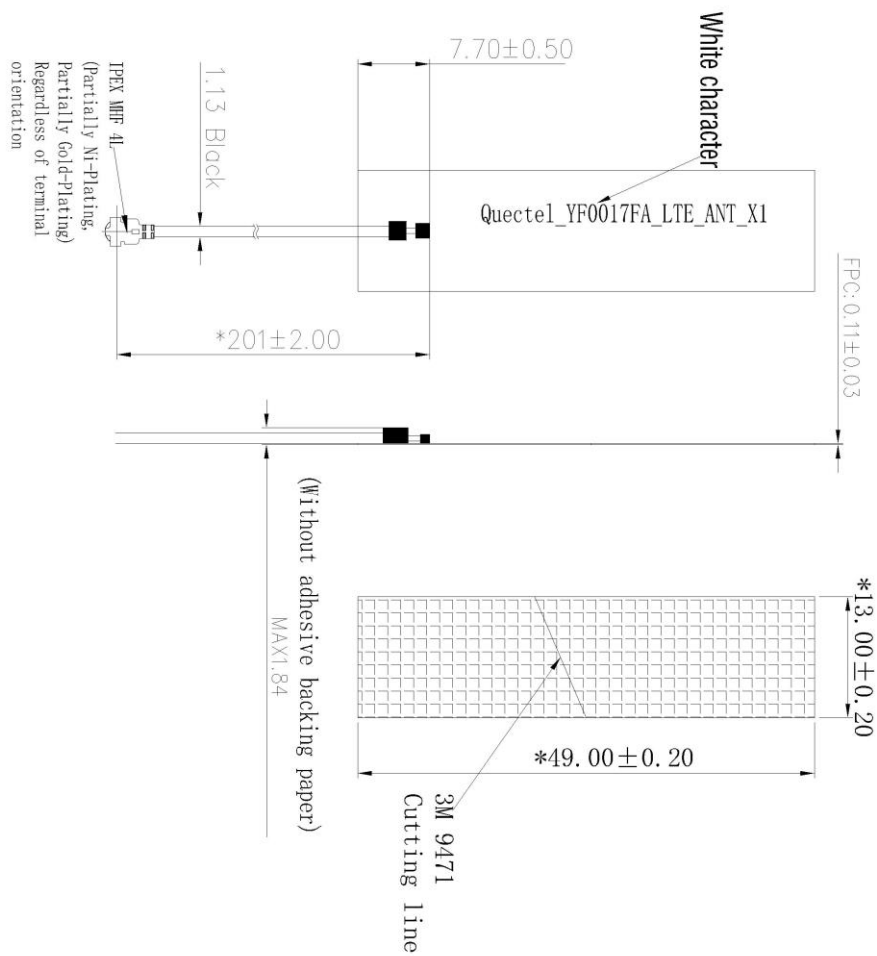

3 Detailed Performance

3.1. S-Parameter Test

3.1.1. VSWR

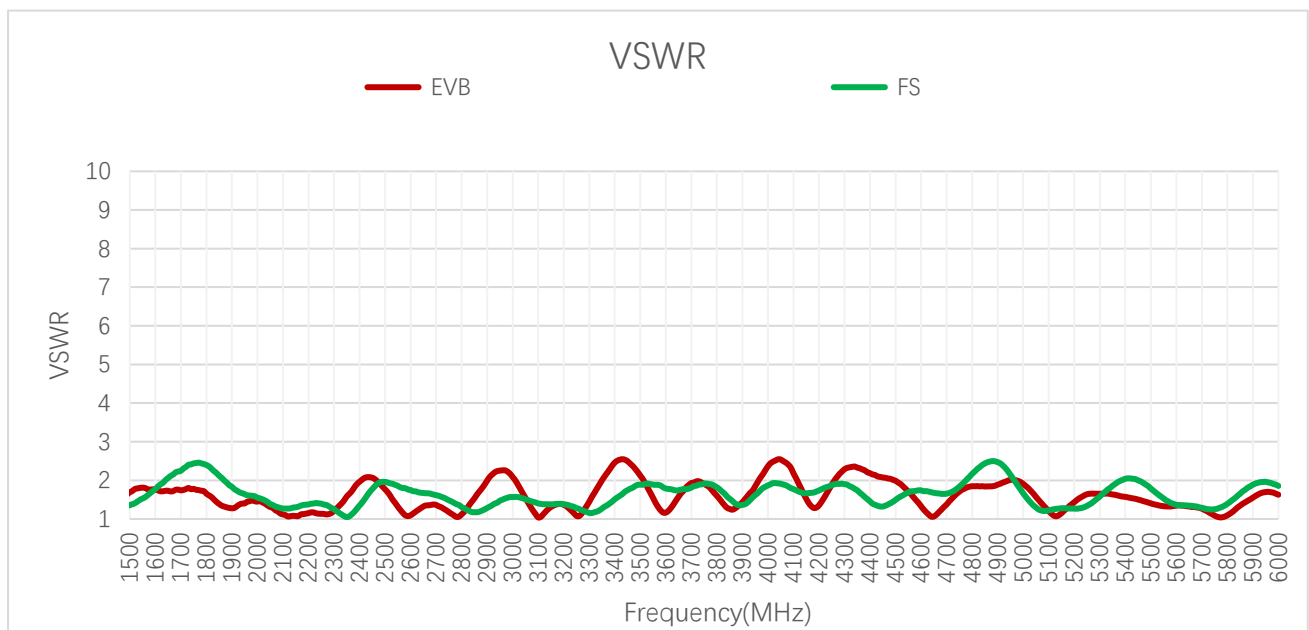

VSWR

Frequency (MHz)		600	630	710	830	900	960	1440	1710	1740	1880
VSWR	EVB	-	-	-	-	-	-	-	1.8	1.8	1.3
	FS	-	-	-	-	-	-	-	2.3	2.4	1.9
Frequency (MHz)		1950	2140	2350	2450	2600	3600	4700	5000	5500	6000
VSWR	EVB	1.4	1.1	1.6	2.1	1.1	1.2	1.4	1.9	1.4	1.6
	FS	1.6	1.3	1.0	1.8	1.7	1.8	1.7	1.7	1.8	1.9

3.1.2. Return Loss

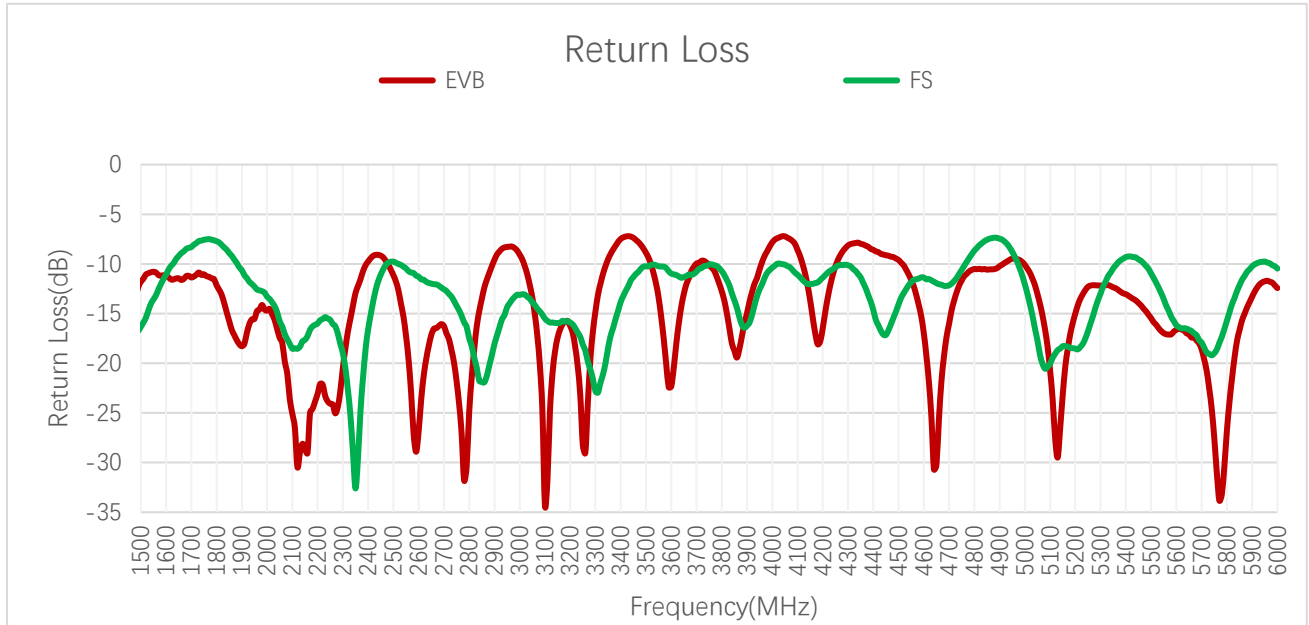

Return Loss (dB)

Frequency (MHz)		600	630	710	830	900	960	1440	1710	1740	1880
Return Loss (dB)	EVB	-	-	-	-	-	-	-	-11.3	-11.1	-17.7
	FS	-	-	-	-	-	-	-	-8.1	-7.7	-9.9
Frequency (MHz)		1950	2140	2350	2450	2600	3600	4700	5000	5500	6000
Return Loss (dB)	EVB	-15.5	-28.1	-12.9	-9.2	-26.8	-22.3	-16.0	-10.1	-15.5	-12.4
	FS	-12.3	-17.8	-32.6	-11.1	-11.3	-11.0	-12.2	-12.1	-11.0	-10.5

3.2. Radiation Performance Test

3.2.1. Efficiency

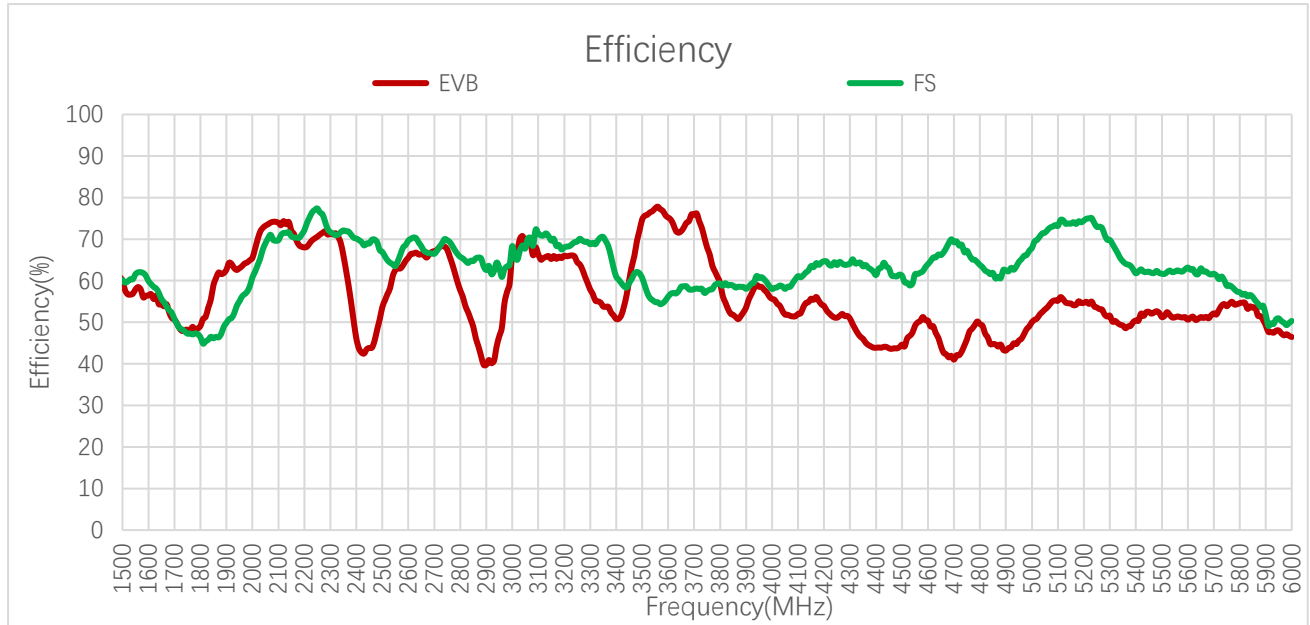

Efficiency (%)

Frequency (MHz)		600	630	710	830	900	960	1440	1710	1740	1880
Efficiency (%)	EVB	-	-	-	-	-	-	-	49.7	48.2	61.6
	FS	-	-	-	-	-	-	-	49.6	47.8	47.2
Frequency (MHz)		1950	2140	2350	2450	2600	3600	4700	5000	5500	6000
Efficiency (%)	EVB	63.0	74.1	66.1	43.8	65.5	75.2	41.0	50.1	51.3	46.4
	FS	55.0	71.6	72.1	68.9	69.7	56.2	69.2	67.9	61.7	50.3

3.2.2. Average Gain

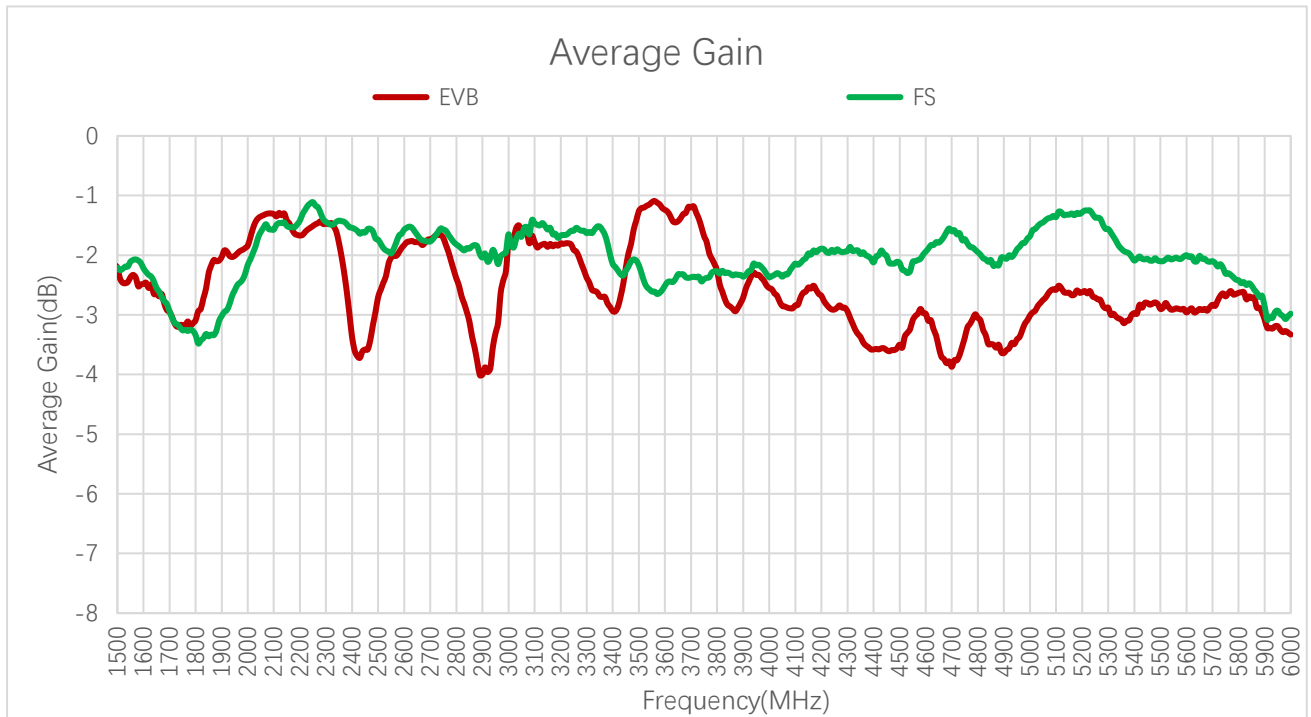

Average Gain (dB)

Frequency (MHz)	600	630	710	830	900	960	1440	1710	1740	1880	
Average Gain (dB)	EVB	-	-	-	-	-	-	-3.0	-3.2	-2.1	
	FS	-	-	-	-	-	-	-3.1	-3.2	-3.3	
Frequency (MHz)	1950	2140	2350	2450	2600	3600	4700	5000	5500	6000	
Average Gain (dB)	EVB	-2.0	-1.3	-1.8	-3.6	-1.8	-1.2	-3.9	-3.0	-2.9	-3.3
	FS	-2.6	-1.5	-1.4	-1.6	-1.6	-2.5	-1.6	-1.7	-2.1	-3.0

3.2.3. Peak Gain

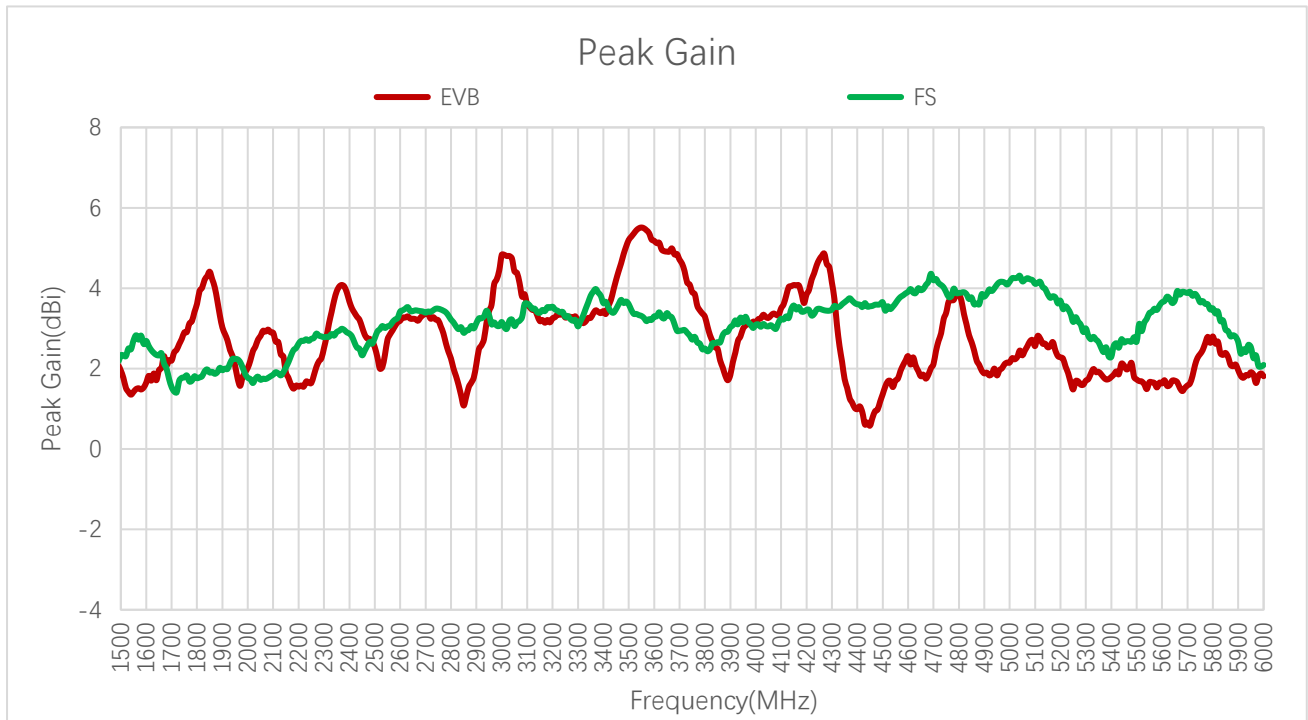

Peak Gain (dBi)

Frequency (MHz)	600	630	710	830	900	960	1440	1710	1740	1880	
Peak Gain (dBi)	EVB	-	-	-	-	-	-	2.4	2.7	3.7	
	FS	-	-	-	-	-	-	1.4	1.8	1.9	
Frequency (MHz)	1950	2140	2350	2450	2600	3600	4700	5000	5500	6000	
Peak Gain (dBi)	EVB	2.1	2.3	3.9	3.0	3.2	5.2	2.1	2.2	1.7	1.8
	FS	2.2	1.9	2.9	2.3	3.4	3.3	4.2	4.2	2.7	2.1

3.2.4. 3D & 2D Radiation Pattern

3.2.4.1. Test Condition: Stick to ABS Board on 130 mm × 130 mm EVB Board

- Test Chamber: HF-G-1

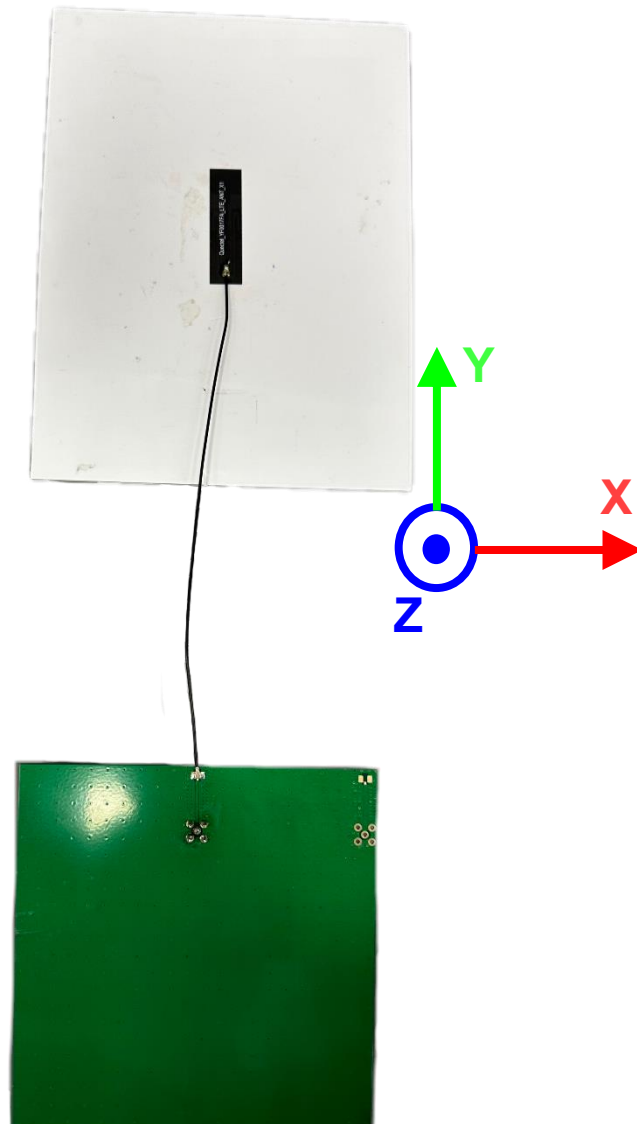

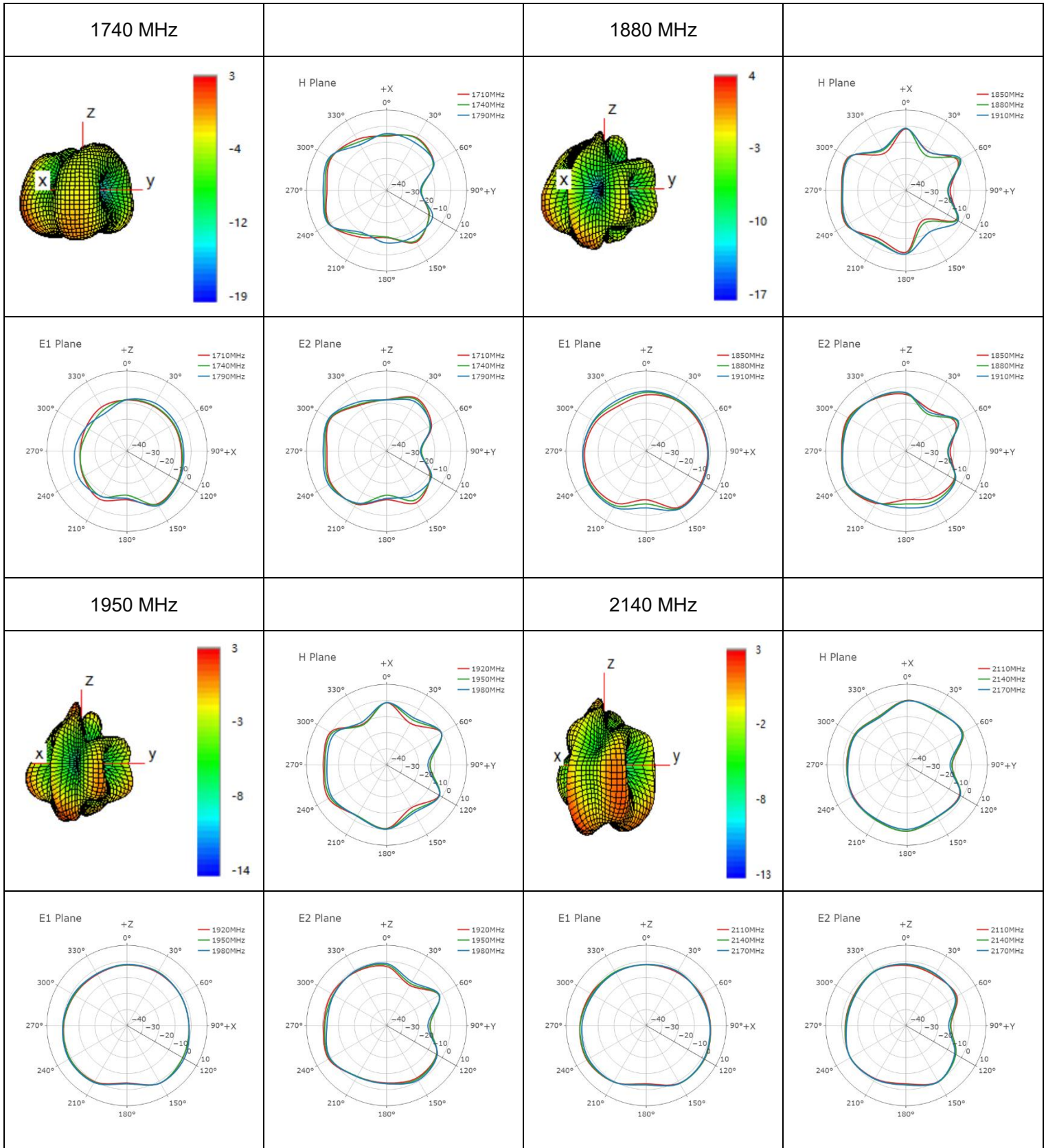

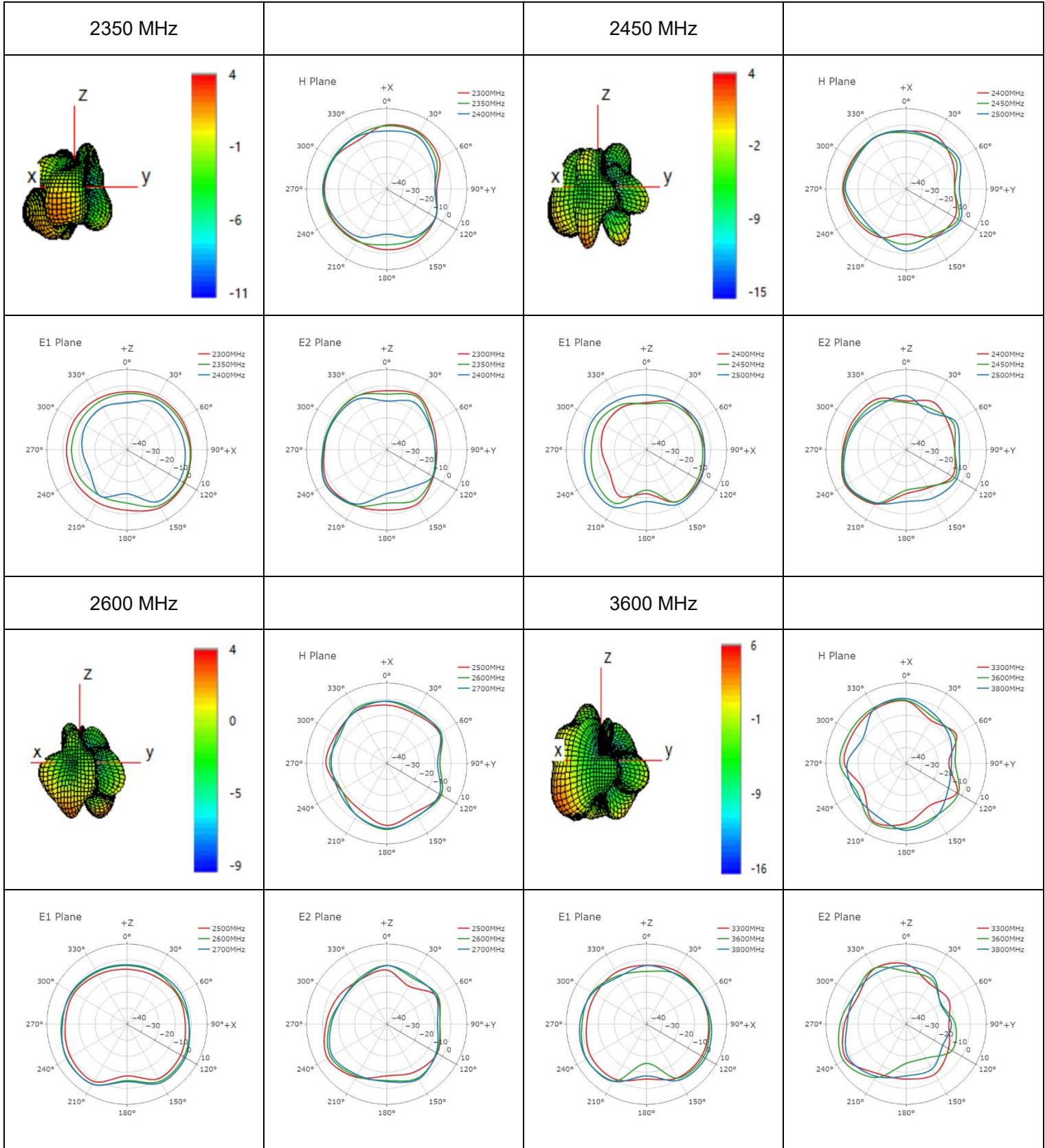

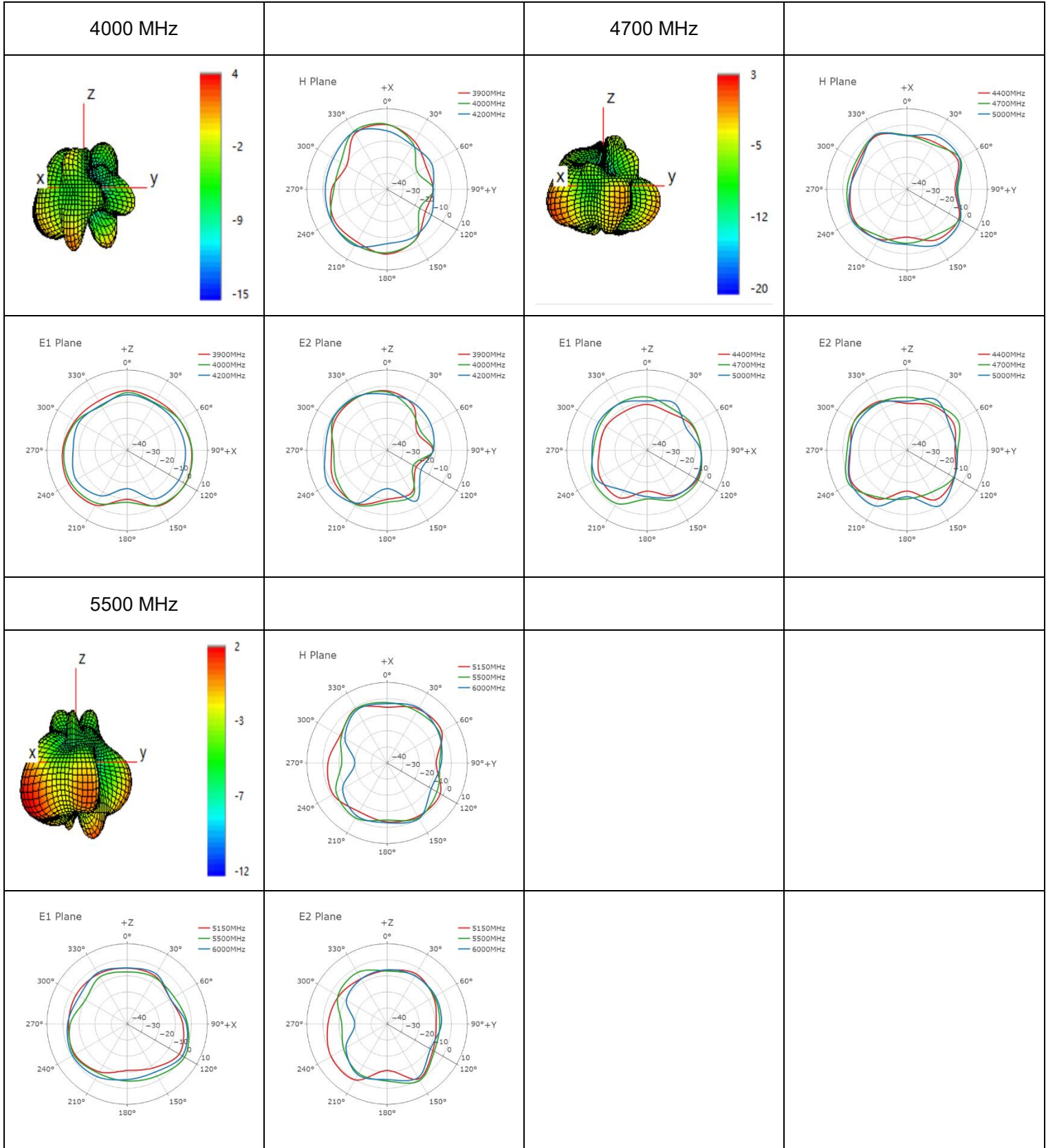

3.2.4.2. Test Condition: Free Space

- Test Chamber: HF-G-1

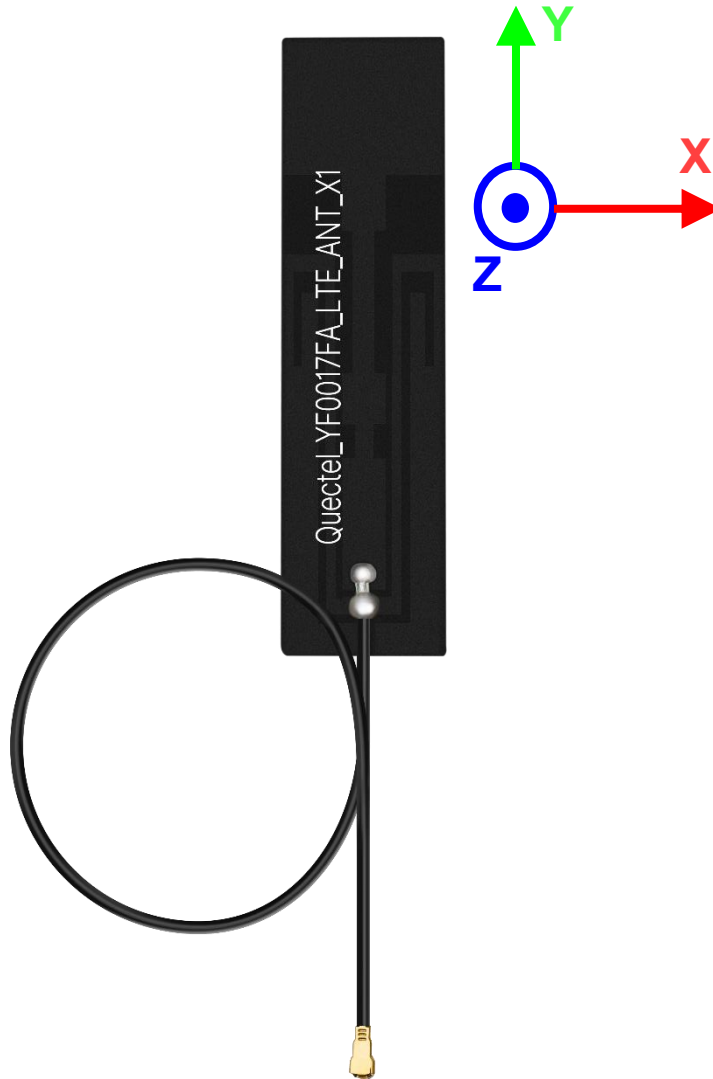

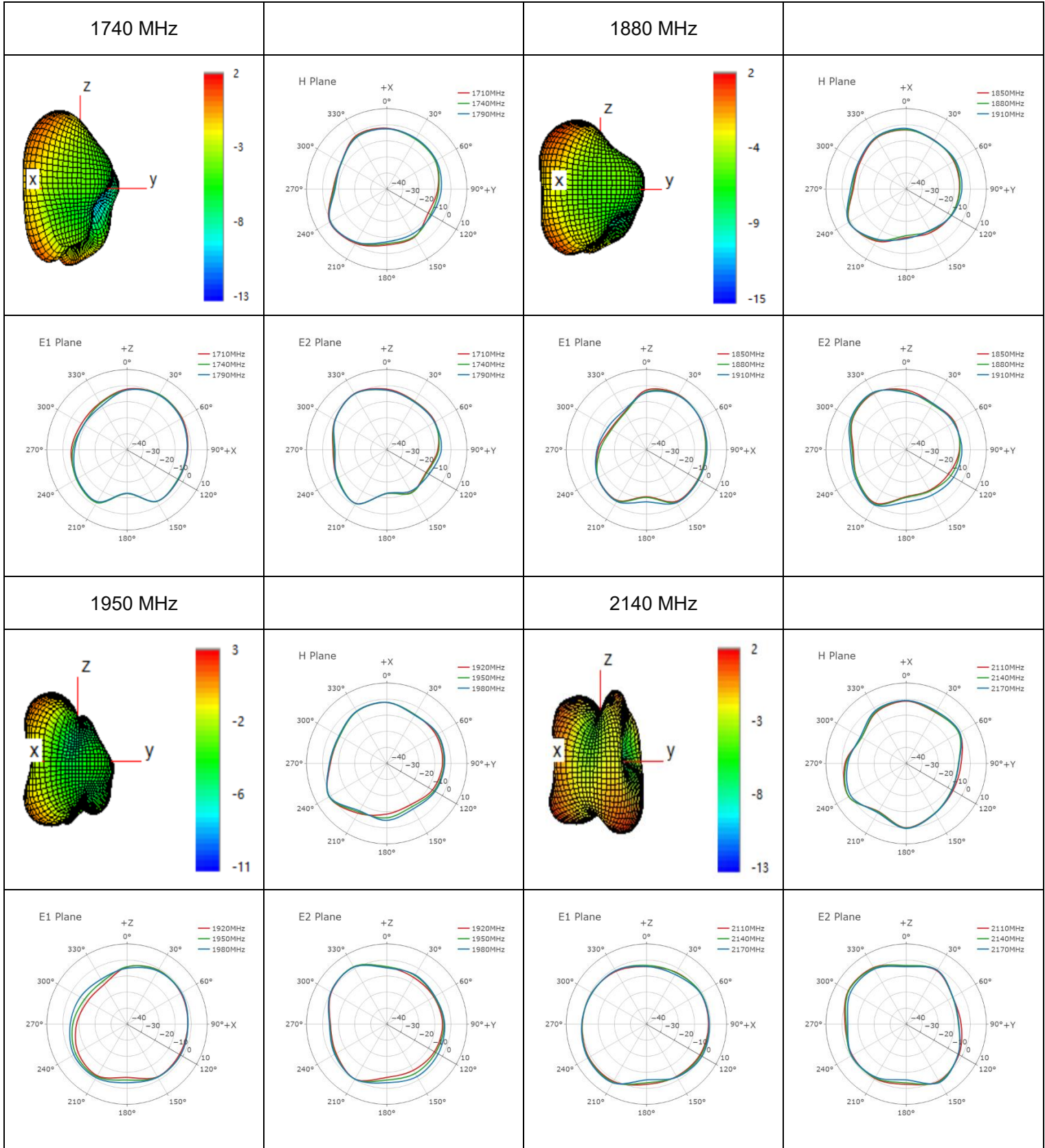

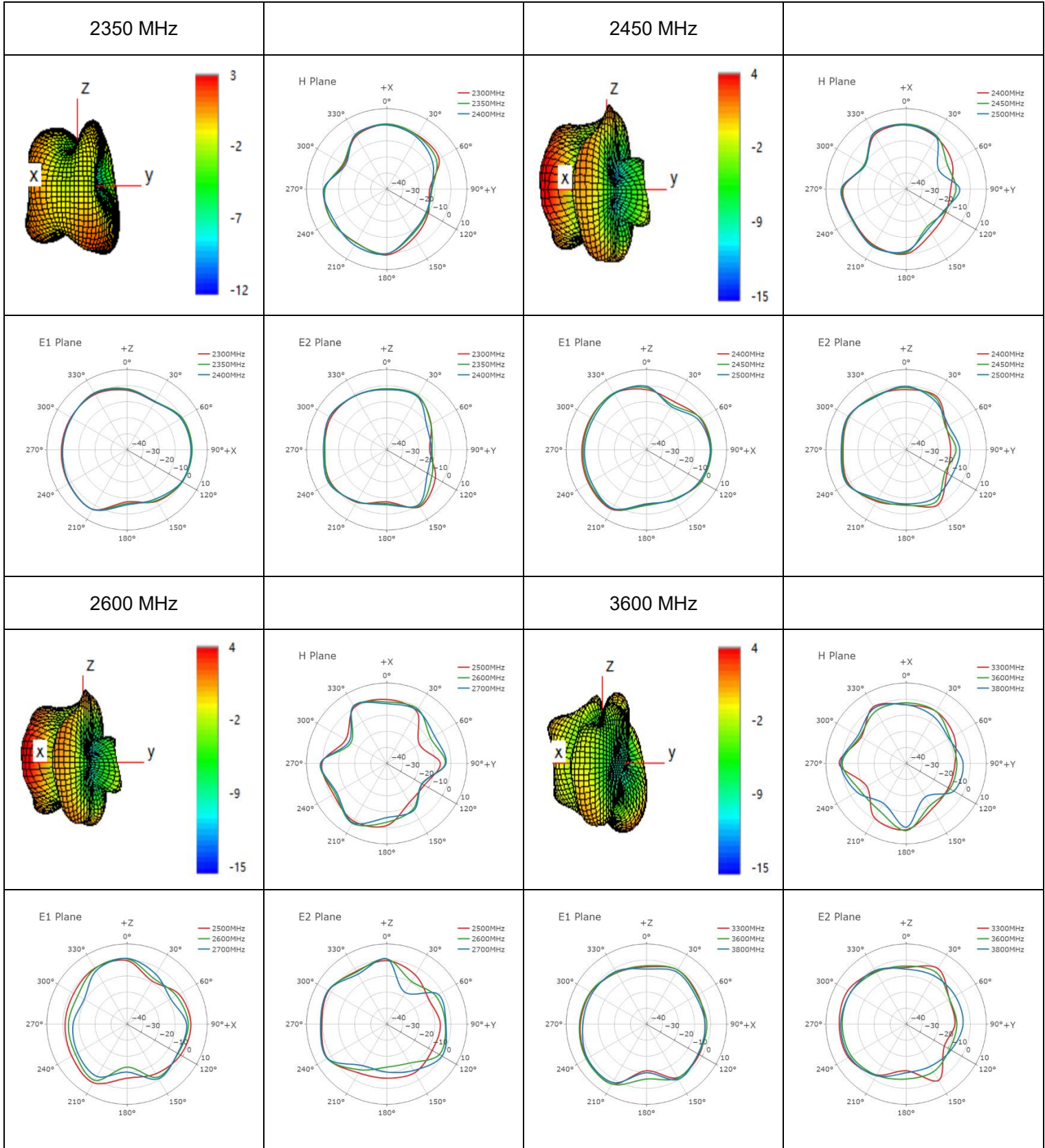

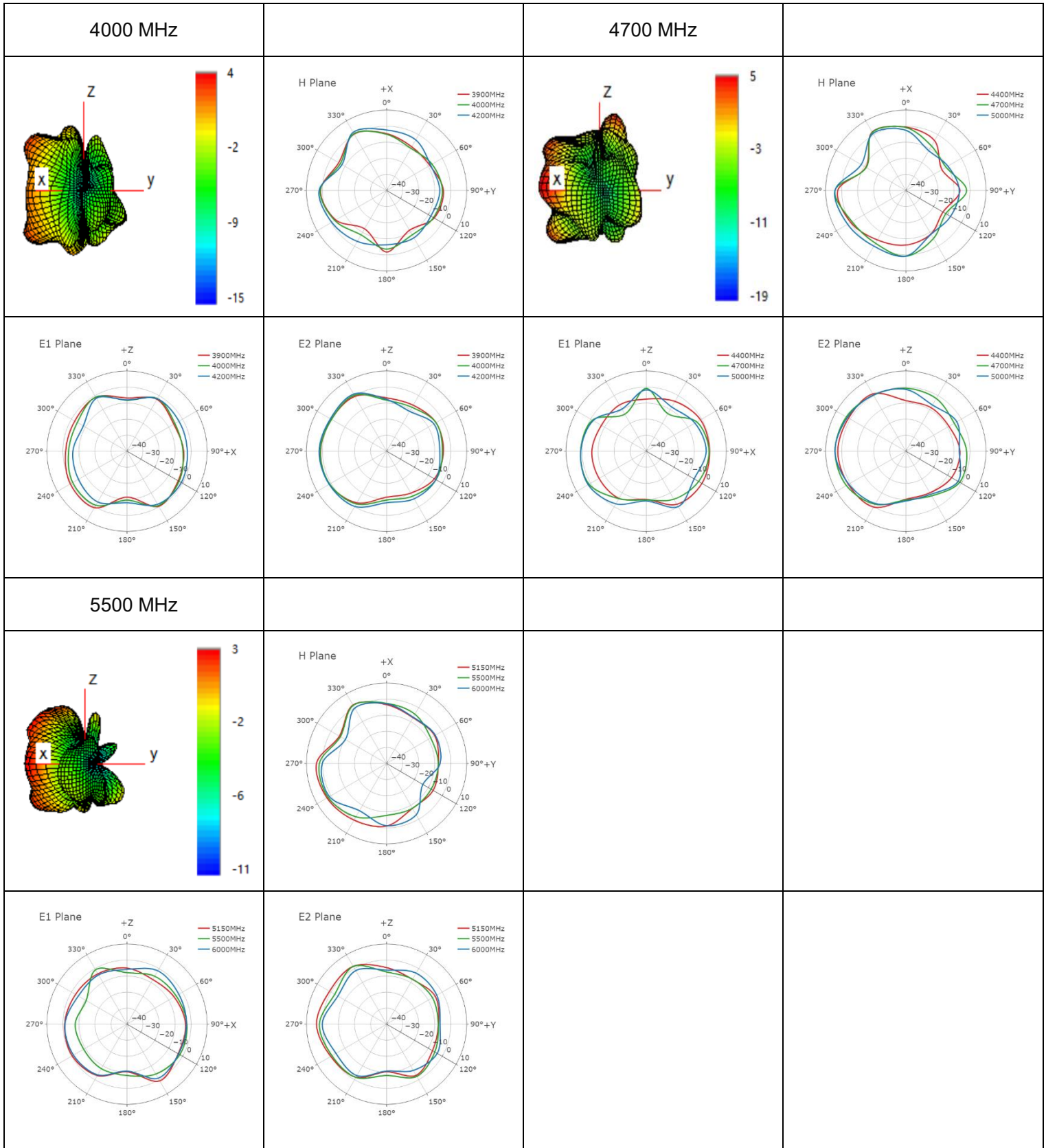

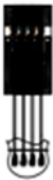

4 Packaging

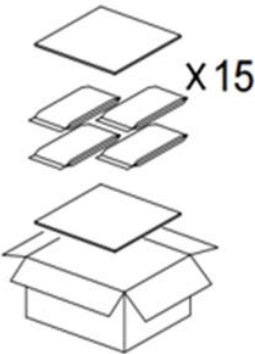
Step	Packaging Picture / 2D Picture	Description
1	 <p>20pcs/tie</p>	<p>The product terminal is wrapped with EPE foam. (20 PCS / Tie)</p>
2	 <p>x10 小袋 200pcs/bag</p>	<p>200 antenna products in a PE bag. (200 Antennas / PE Bag)</p>
3	 <p>x15</p>	<p>(15 PE Bags / Carton Box) (3000 Antennas / Carton Box)</p> <p><u>Carton Size:</u> <u>L × W × H = 340 × 260 × 140 mm</u></p>

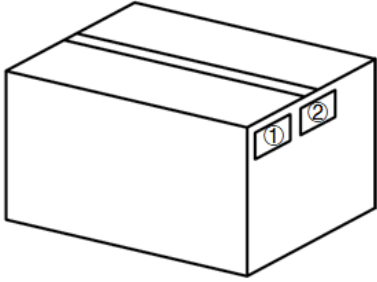
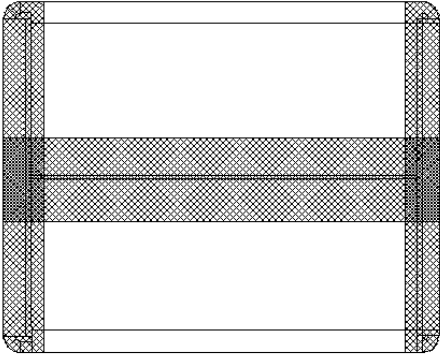
4	 A 3D perspective drawing of a rectangular cardboard box. On the front face, there are two small rectangular labels. The left label is marked with a circled '1' and the right label is marked with a circled '2'.	<p>Position for Attaching Labels</p> <ul style="list-style-type: none">① Carton Label② Quality Label
5	 A 3D perspective drawing of a rectangular cardboard box. The box is shown with a cross-hatched texture, indicating it is sealed. The sealing is applied in an H-shape, covering the top, bottom, and side edges of the box.	<p>Sealing Cartons H-shaped sealing cartons</p>

Contact Us

At Quectel, our aim is to provide timely and comprehensive services to our customers. If you require any assistance, please contact our headquarters:

Quectel Wireless Solutions Co., Ltd.

Building 5, Shanghai Business Park Phase III (Area B), No.1016 Tianlin Road, Minhang District, Shanghai 200233, China

Tel: +86 21 5108 6236

Email: info@quectel.com

Or our local offices. For more information, please visit:

<http://www.quectel.com/support/sales.htm>.

For technical support, or to report documentation errors, please visit:

<http://www.quectel.com/support/technical.htm>.

Or email us at: support@quectel.com.

Legal Notices

We offer information as a service to you. The provided information is based on your requirements and we make every effort to ensure its quality. You agree that you are responsible for using independent analysis and evaluation in designing intended products, and we provide reference designs for illustrative purposes only. Before using any hardware, software or service guided by this document, please read this notice carefully. Even though we employ commercially reasonable efforts to provide the best possible experience, you hereby acknowledge and agree that this document and related services hereunder are provided to you on an “as available” basis. We may revise or restate this document from time to time at our sole discretion without any prior notice to you.

Use and Disclosure Restrictions

License Agreements

Documents and information provided by us shall be kept confidential, unless specific permission is granted. They shall not be accessed or used for any purpose except as expressly provided herein.

Copyright

Our and third-party products hereunder may contain copyrighted material. Such copyrighted material shall not be copied, reproduced, distributed, merged, published, translated, or modified without prior written consent. We and the third party have exclusive rights over copyrighted material. No license shall be granted or conveyed under any patents, copyrights, trademarks, or service mark rights. To avoid ambiguities, purchasing in any form cannot be deemed as granting a license other than the normal non-exclusive, royalty-free license to use the material. We reserve the right to take legal action for noncompliance with abovementioned requirements, unauthorized use, or other illegal or malicious use of the material.

Trademarks

Except as otherwise set forth herein, nothing in this document shall be construed as conferring any rights to use any trademark, trade name or name, abbreviation, or counterfeit product thereof owned by Quectel or any third party in advertising, publicity, or other aspects.

Third-Party Rights

This document may refer to hardware, software and/or documentation owned by one or more third parties (“third-party materials”). Use of such third-party materials shall be governed by all restrictions and obligations applicable thereto.

We make no warranty or representation, either express or implied, regarding the third-party materials, including but not limited to any implied or statutory, warranties of merchantability or fitness for a particular purpose, quiet enjoyment, system integration, information accuracy, and non-infringement of any third-party intellectual property rights with regard to the licensed technology or use thereof. Nothing herein constitutes a representation or warranty by us to either develop, enhance, modify, distribute, market, sell, offer for sale, or otherwise maintain production of any our products or any other hardware, software, device, tool, information, or product. We moreover disclaim any and all warranties arising from the course of dealing or usage of trade.

Privacy Policy

To implement module functionality, certain device data are uploaded to Quectel's or third-party's servers, including carriers, chipset suppliers or customer-designated servers. Quectel, strictly abiding by the relevant laws and regulations, shall retain, use, disclose or otherwise process relevant data for the purpose of performing the service only or as permitted by applicable laws. Before data interaction with third parties, please be informed of their privacy and data security policy.

Disclaimer

- a) We acknowledge no liability for any injury or damage arising from the reliance upon the information.
- b) We shall bear no liability resulting from any inaccuracies or omissions, or from the use of the information contained herein.
- c) While we have made every effort to ensure that the functions and features under development are free from errors, it is possible that they could contain errors, inaccuracies, and omissions. Unless otherwise provided by valid agreement, we make no warranties of any kind, either implied or express, and exclude all liability for any loss or damage suffered in connection with the use of features and functions under development, to the maximum extent permitted by law, regardless of whether such loss or damage may have been foreseeable.
- d) We are not responsible for the accessibility, safety, accuracy, availability, legality, or completeness of information, advertising, commercial offers, products, services, and materials on third-party websites and third-party resources.

Copyright © Quectel Wireless Solutions Co., Ltd. 2025. All rights reserved.

Revision History

Version	Date	Author	Note
-	2022-07-25	Simon SHENG/ Joye WANG	Creation of the document
1.0	2022-07-25	Simon SHENG/ Joye WANG	First official release
1.1	2023-06-12	David LIU/ Vinnie LIU	Added the packaging information (Chapter 6)
2.0	2023-10-24	Nico PAN/ Lucky FENG/ David LIU/ Aria CHU	Updated all test data in this datasheet.
2.1	2024-06-07	Joye WANG	Updated the drawing (Chapter 2).
2.2	2025-04-16	Aria CHU	Updated the antenna image (Cover page).

QUECTEL

www.quectel.com