



Antenna Datasheet

Product OC: YEMX223J1A

Version: 2.1

Date: 2025-09-19

Status: Released

Product Name: 5G 2in1 Multiple Mount Combo External Antenna

Key Features:

Frequency Band: 410–470 MHz, 617–960 MHz, 1420–1520 MHz,
1710–2690 MHz, 3300–3800 MHz, 4000–6000 MHz

Dimensions: 186 mm × 176 mm × 100.5 mm

Efficiency: Up to 83.4 % (4G/5G-1)

RoHS and REACH Compliant

IP67

Overview

This ultra-wide-band 5G/4G antenna box provides broad coverage from 410–6000 MHz whilst backward-compatible to support 3G/2G networks as well as Cat-M and NB-IoT. The antenna is designed for ease of integration with connection via 2 various cable lengths from 500–5000 mm, terminated with SMA connectors. This pole/wall/suction mount omni-directional antenna is easy to install with maximum durability with its IP67 ASA enclosure. It is compatible with Quectel's RM520x Series modules. Quectel provides comprehensive antenna design support such as simulation, testing and manufacturing for custom antenna solutions to meet your specific application needs.

Contents

Overview	1
Contents	2
1 Specification	3
1.1. Electrical.....	3
1.1.1. 4G/5G-1	4
1.1.2. 4G/5G-2	5
1.2. Mechanical & Environmental	6
2 Drawing	7
3 Detailed Performance	8
3.1 S-Parameter Test	8
3.1.1 VSWR	8
3.1.2 Return Loss.....	10
3.1.3 Isolation.....	12
3.2 Radiation Performance Test.....	13
3.2.1 Efficiency.....	13
3.2.2 Average Gain	15
3.2.3 Peak Gain	17
3.2.4 3D & 2D Radiation Pattern	19
4 Packaging	30
5 Installation	32
Contact Us	36
Legal Notices	37
Revision History	39

1 Specification

Test Condition: Free Space

1.1. Electrical

Electrical	
Frequency Range	410–470 MHz, 617–960 MHz, 1420–1520 MHz, 1710–2690 MHz, 3300–3800 MHz, 4000–6000 MHz
Radiation Pattern	Omni-directional
Polarization	Linear
Impedance	50 Ω
Isolation	≤ -8.5 dB

1.1.1. 4G/5G-1

Electrical – Detail												
	Band	B71	B12 /B13 /B28	B5 /B8 /B26	n74 /n75 /n76	B1 /B2 /B3	B40	Wi-Fi 2G	B38 /B41	B42 /B48 /n77	n79	Wi-Fi 5G
	Freq. (MHz)	610– 700	700– 810	820– 960	1420– 1520	1700– 2170	2300– 2400	2400– 2500	2500– 2690	3300– 4200	4400– 5000	5150– 5850
Max. VSWR		4.7	2.7	2.0	2.2	1.9	1.5	1.7	2.2	2.0	1.7	2.1
Max. Return Loss (dB)		-3.7	-6.7	-9.8	-8.7	-10.0	-14.6	-11.4	-8.6	-9.7	-11.8	-9.2
AVG Eff. (%)		40.2	66.9	76.3	55.6	60.0	70.2	58.1	57.3	60.1	63.5	58.1
AVG AVG Gain (dB)		-4.0	-1.7	-1.2	-2.6	-2.2	-1.5	-2.4	-2.4	-2.2	-2.0	-2.4
Max. Peak Gain (dBi)		2.4	5.0	4.9	3.3	4.3	3.0	4.7	5.1	4.2	3.2	2.9
VSWR												≤ 4.7
Return Loss												≤ -3.7 dB
Peak Gain												≤ 5.1 dBi

Electrical – Detail				
SPEC	Band	B87/B88	B31/B72/B73	
	Freq. (MHz)	410–430 MHz	450–470 MHz	
Max. VSWR		3.7	2.9	
Max. Return Loss (dB)		-4.8	-6.2	
AVG Eff. (%)		40.1	34.6	
AVG AVG Gain (dB)		-4.0	-4.7	
Max. Peak Gain (dBi)		-0.3	0.5	
VSWR				≤ 3.7
Return Loss				≤ -4.8 dB
Peak Gain				≤ 0.5 dBi

1.1.2. 4G/5G-2

Electrical – Detail												
	Band	B71	B12 /B13 /B28	B5 /B8 /B26	n74 /n75 /n76	B1 /B2 /B3	B40	Wi-Fi 2G	B38 /B41	B42 /B48 /n77	n79	Wi-Fi 5G
	Freq. (MHz)	610– 700	700– 810	820– 960	1420– 1520	1700– 2170	2300– 2400	2400– 2500	2500– 2690	3300– 4200	4400– 5000	5150– 5850
Max. VSWR		4.5	2.8	2.0	2.3	2.2	1.3	1.5	2.1	2.2	1.6	2.1
Max. Return Loss (dB)		-3.9	-6.6	-9.7	-8.0	-8.6	-17.0	-14.0	-8.9	-8.7	-12.3	-9.1
AVG Eff. (%)		37.6	63.6	70.4	46.6	59.1	69.7	60.1	54.3	61.6	67.9	60.2
AVG AVG Gain (dB)		-4.3	-2.0	-1.5	-3.3	-2.3	-1.6	-2.2	-2.7	-2.1	-1.7	-2.2
Max. Peak Gain (dBi)		2.2	3.2	3.9	3.3	4.6	4.2	5.3	4.8	4.2	3.4	3.1
VSWR		≤ 4.5										
Return Loss		≤ -3.9 dB										
Peak Gain		≤ 5.3 dBi										

Electrical – Detail					
SPEC	Band	B87/B88		B31/B72/B73	
	Freq. (MHz)	410–430 MHz		450–470 MHz	
Max. VSWR		3.9		3.3	
Max. Return Loss (dB)		-4.5		-5.4	
AVG Eff. (%)		37.4		36.1	
AVG AVG Gain (dB)		-4.3		-4.5	
Max. Peak Gain (dBi)		1.0		0.7	
VSWR		≤ 3.9			
Return Loss		≤ -4.5 dB			
Peak Gain		≤ 1.0 dBi			

1.2. Mechanical & Environmental

Mechanical	
Antenna Dimensions	186 mm × 176 mm × 100.5 mm
Antenna Material & Color	ASA
Cable Type & Color & Length	ALSR200 & Black & 450 mm
Connector Type	SMA Male
Weight	Typ. 450 g
Mounting Type	pole / wall / suction cup
Environmental	
Operation Temperature	-40 °C to +85 °C
Storage Temperature	-40 °C to +85 °C
Ingress Protection (IP) Rating	IP67
Impact Protection (IK) Rating	IK09
RoHS & REACH Compliant	Yes
Housing UV Resistant	UL 746c f1

2 Drawing

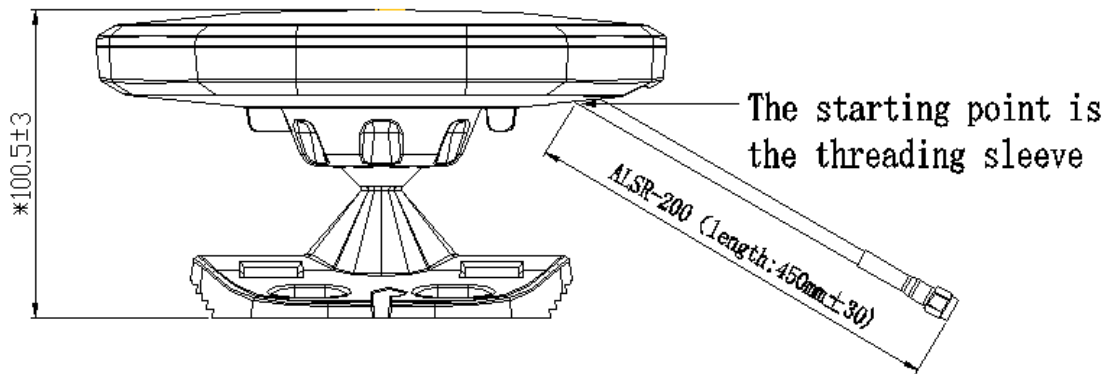
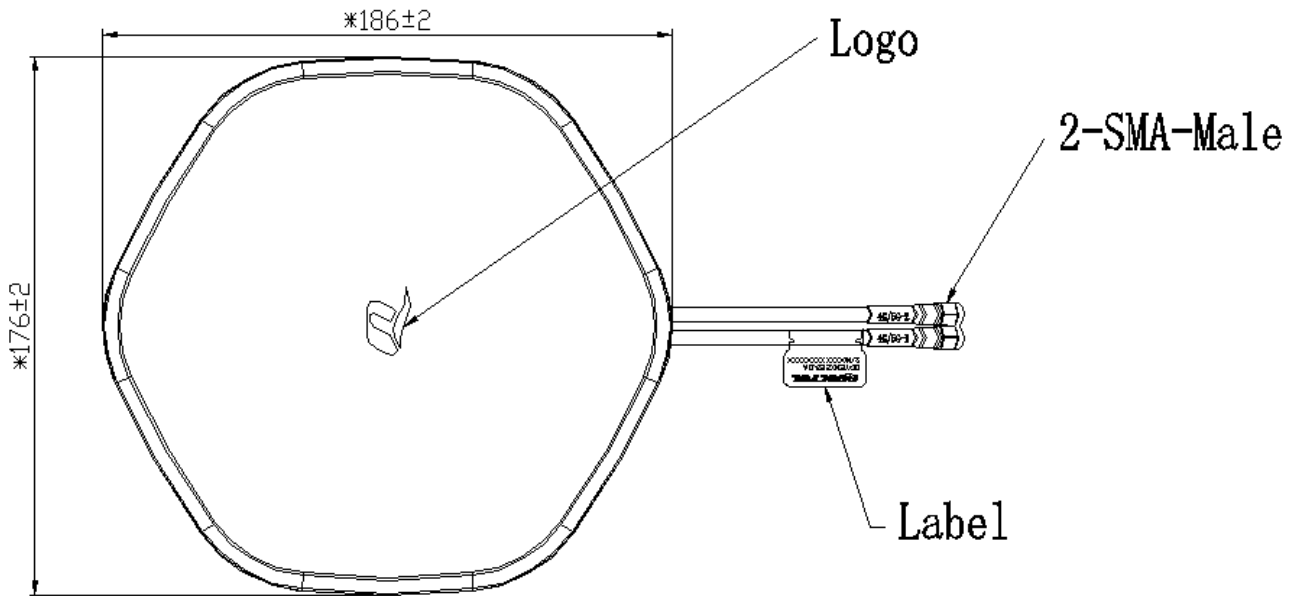

3 Detailed Performance

3.1 S-Parameter Test

3.1.1 VSWR

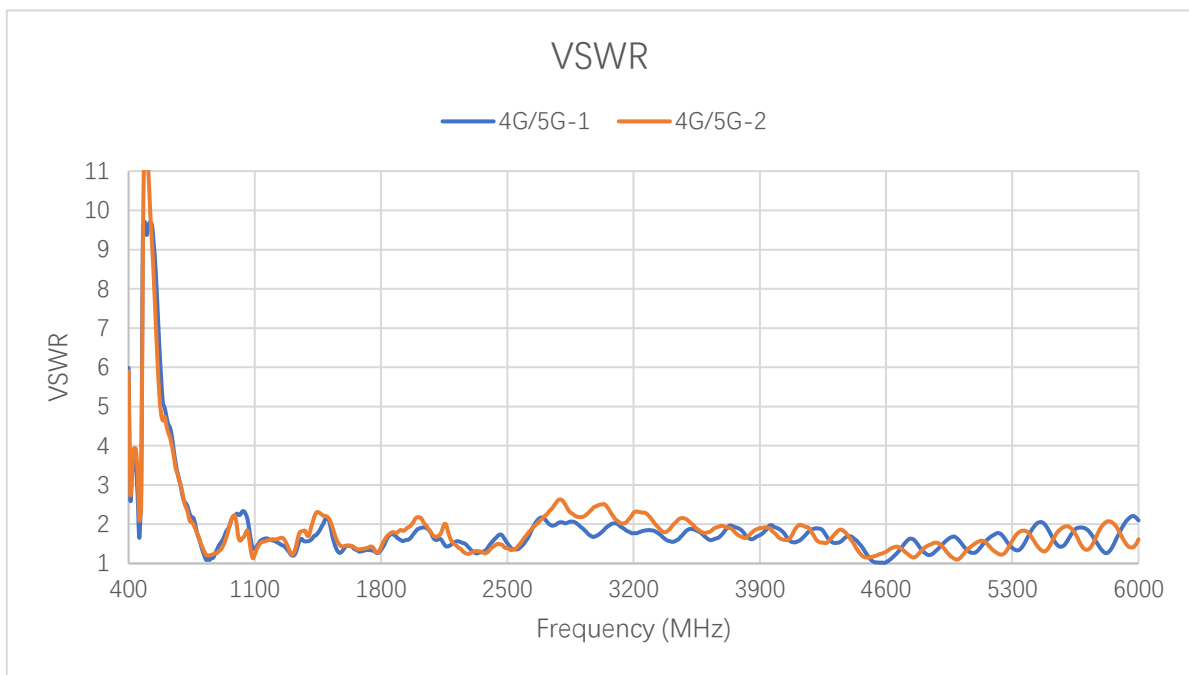

VSWR

Frequency (MHz)	600	630	710	830	900	960	1440	1710	1740	1880
4G/5G-1	5.0	4.5	2.6	1.1	1.5	2.0	1.7	1.3	1.3	1.7
4G/5G-2	4.7	4.2	2.5	1.2	1.3	2.0	2.3	1.4	1.4	1.8
Frequency (MHz)	1950	2140	2350	2450	2600	3600	4700	5000	5500	6000
4G/5G-1	1.6	1.6	1.3	1.7	1.6	1.7	1.5	1.6	1.9	2.1
4G/5G-2	1.9	1.9	1.3	1.5	1.7	1.8	1.3	1.1	1.4	1.6

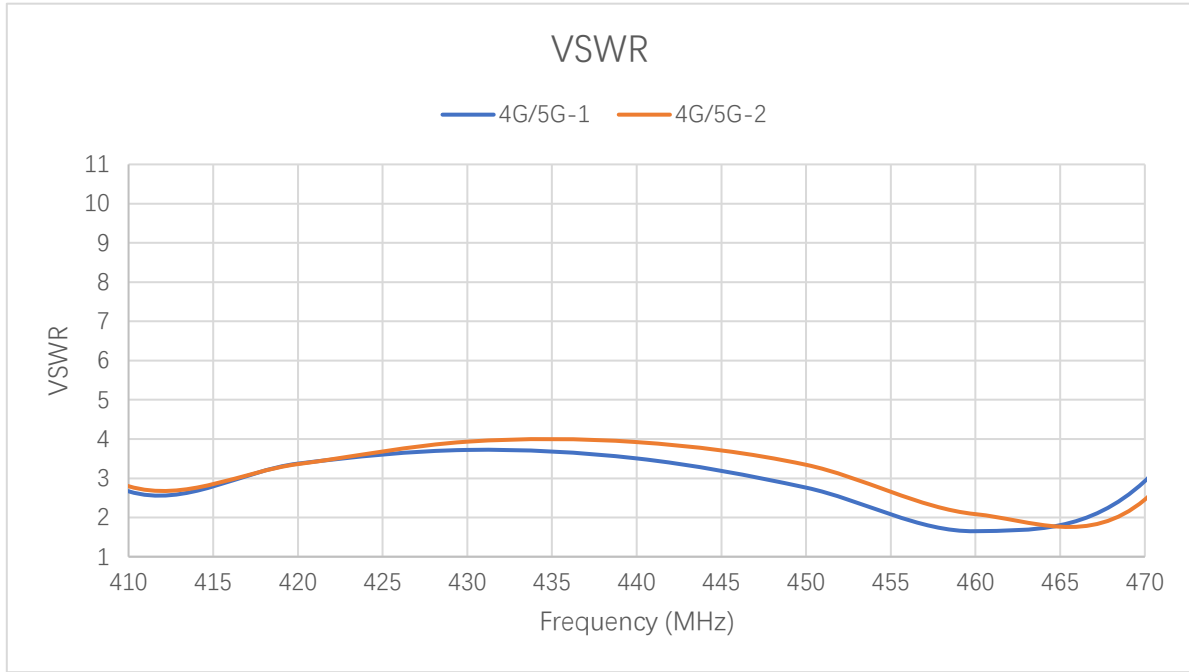

VSWR

Frequency (MHz)	410	420	430	440	450	460	470
4G/5G-1	2.7	3.4	3.7	3.5	2.8	1.7	2.9
4G/5G-2	2.8	3.4	3.9	3.9	3.3	2.1	2.5

3.1.2 Return Loss



Return Loss (dB)

Frequency (MHz)	600	630	710	830	900	960	1440	1710	1740	1880
4G/5G-1	-3.5	-4.0	-7.1	-27.2	-14.7	-9.8	-11.5	-16.9	-16.8	-11.7
4G/5G-2	-3.7	-4.2	-7.3	-20.1	-17.3	-9.7	-8.1	-15.9	-15.0	-11.0
Frequency (MHz)	1950	2140	2350	2450	2600	3600	4700	5000	5500	6000
4G/5G-1	-12.7	-13.1	-18.2	-11.6	-13.2	-12.0	-14.1	-12.6	-10.4	-9.0
4G/5G-2	-10.0	-10.4	-17.5	-14.0	-11.9	-11.1	-17.3	-25.9	-15.7	-12.6

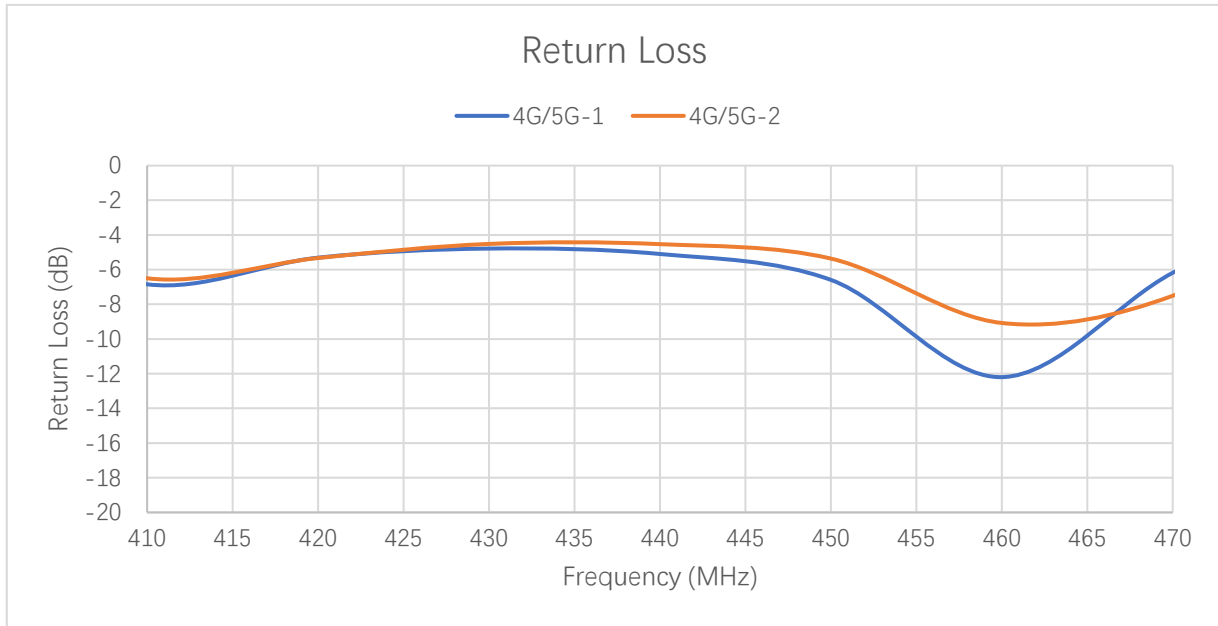

Return Loss (dB)

Frequency (MHz)	410	420	430	440	450	460	470
4G/5G-1	-6.8	-5.3	-4.8	-5.1	-6.6	-12.2	-6.2
4G/5G-2	-6.5	-5.3	-4.5	-4.5	-5.4	-9.1	-7.5

3.1.3 Isolation

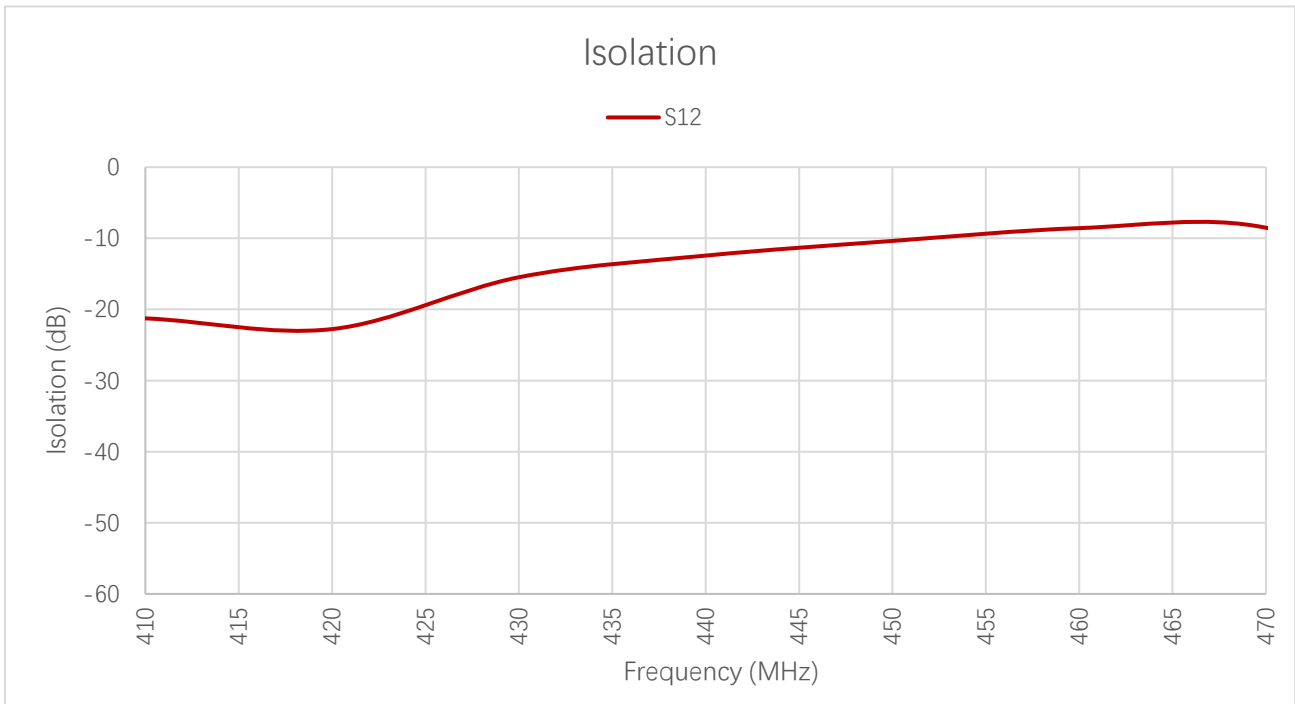
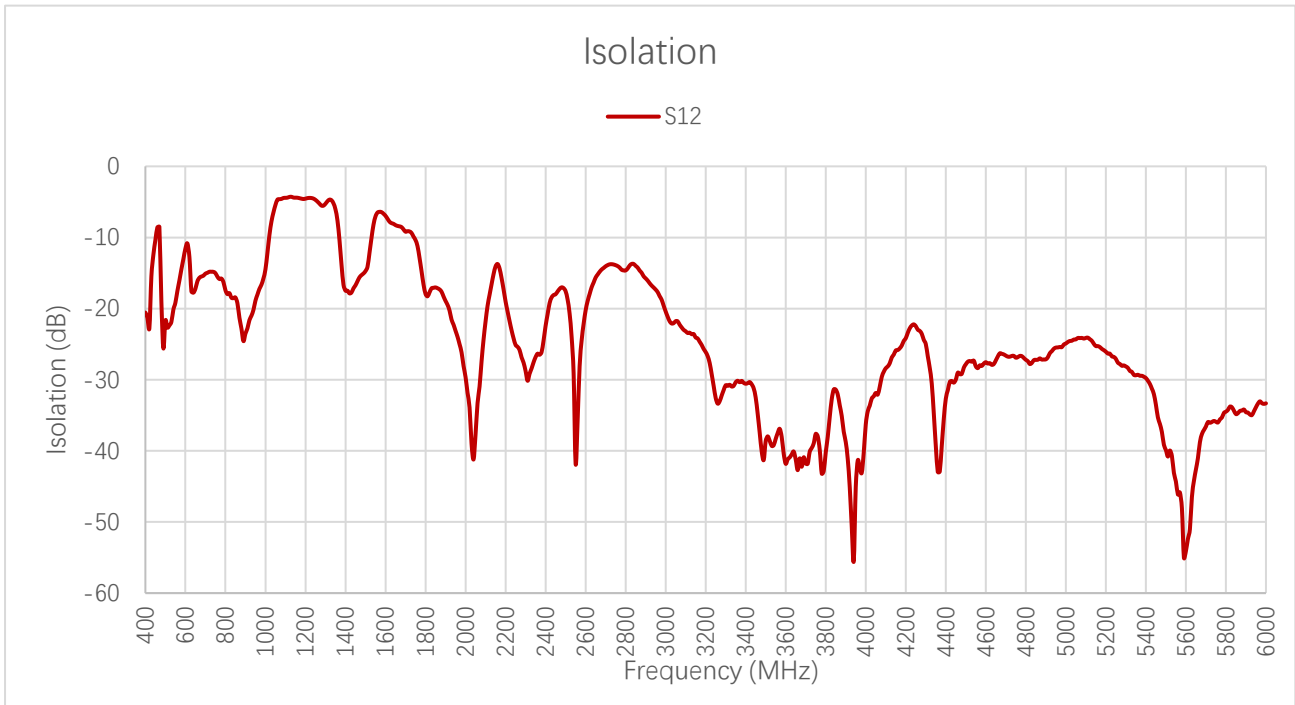

Max Isolation (dB)

Band	B31/B88	B71	B12/B13/B28	B5/B8/B26	n74/n75/n76	B1/B2/B3	B40	Wi-Fi 2G	B38/B41	B42/B48/n77	n79	Wi-Fi 5G
Freq. (MHz)	410–470	600–700	700–810	820–960	1420–1520	1700–2170	2300–2400	2400–2500	2500–2690	3300–4200	4400–5000	5150–5850

Isolation	-8.5	-10.8	-14.8	-17.8	-12.2	-9.1	-22.4	-17.0	-14.3	-24.2	-24.9	-25.3
------------------	------	-------	-------	-------	-------	------	-------	-------	-------	-------	-------	-------

3.2 Radiation Performance Test

3.2.1 Efficiency

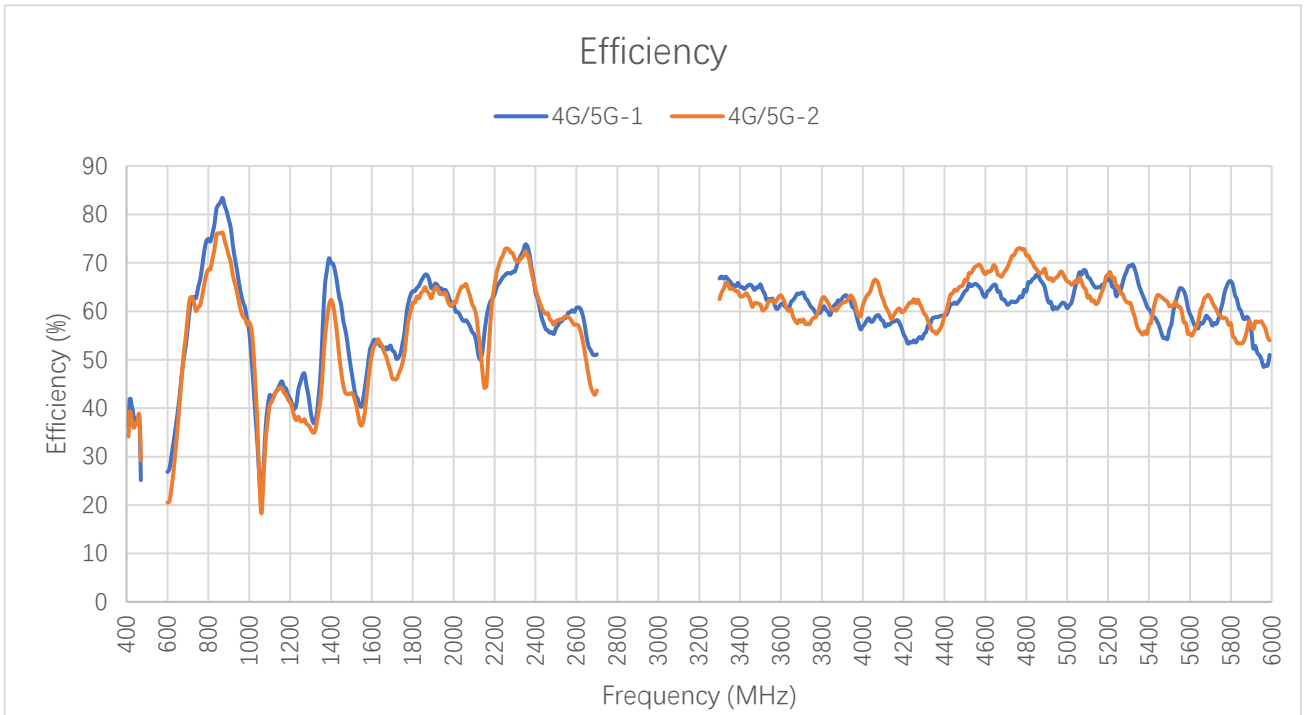

Efficiency (%)

Frequency (MHz)	600	630	710	830	900	960	1440	1710	1740	1880
4G/5G-1	26.8	33.0	60.7	78.0	78.9	63.6	61.2	51.6	51.3	66.5
4G/5G-2	20.5	27.1	62.7	72.8	71.4	60.0	47.4	46.0	48.1	63.6
Frequency (MHz)	1950	2140	2350	2450	2600	3600	4700	5000	5500	6000
4G/5G-1	64.3	51.6	73.8	56.3	60.7	61.5	61.9	60.6	56.3	53.2
4G/5G-2	63.6	47.8	72.3	59.5	57.3	63.3	68.5	66.2	61.0	53.9

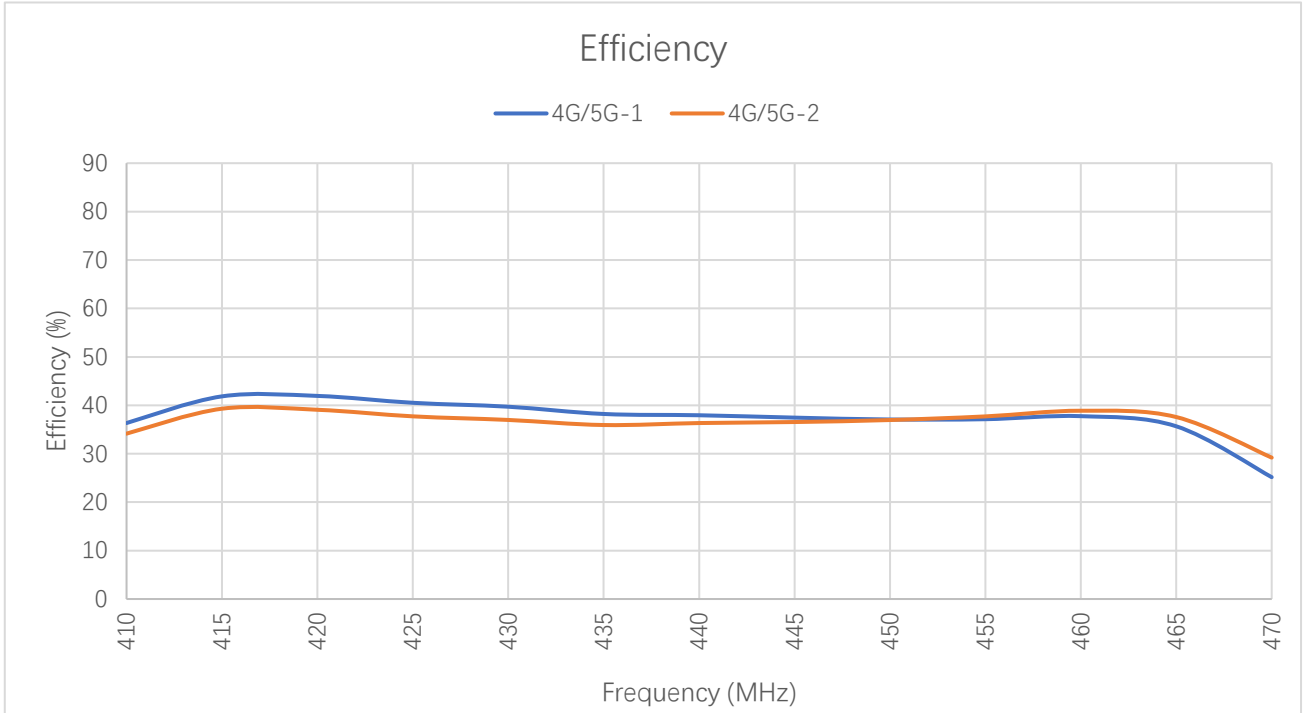

Efficiency (%)

Frequency (MHz)	410	420	430	440	450	460	470
4G/5G-1	36.3	41.9	39.7	38.0	37.1	37.8	25.2
4G/5G-2	34.2	39.1	37.0	36.3	37.0	38.9	29.2

3.2.2 Average Gain

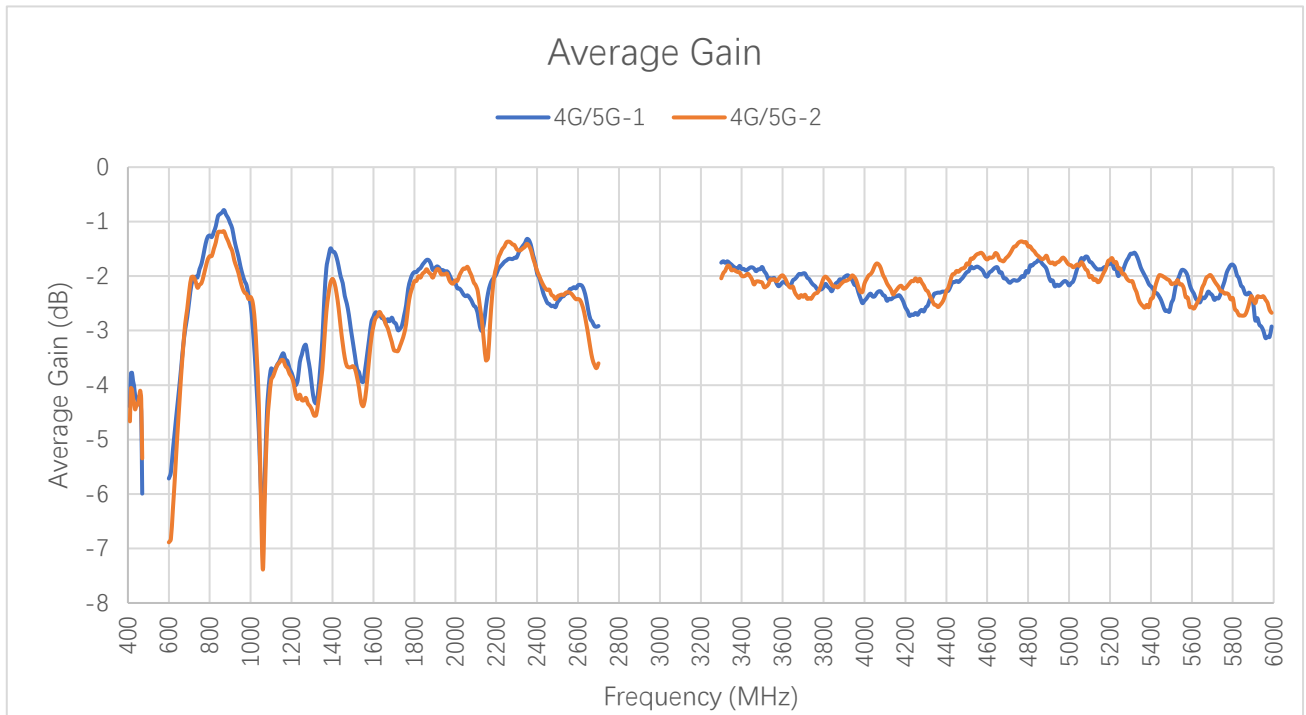

Average Gain (dB)

Frequency (MHz)	600	630	710	830	900	960	1440	1710	1740	1880
4G/5G-1	-5.7	-4.8	-2.2	-1.1	-1.0	-2.0	-2.1	-2.9	-2.9	-1.8
4G/5G-2	-6.9	-5.7	-2.0	-1.4	-1.5	-2.2	-3.2	-3.4	-3.2	-2.0
Frequency (MHz)	1950	2140	2350	2450	2600	3600	4700	5000	5500	6000
4G/5G-1	-1.9	-2.9	-1.3	-2.5	-2.2	-2.1	-2.1	-2.2	-2.5	-2.7
4G/5G-2	-2.0	-3.2	-1.4	-2.3	-2.4	-2.0	-1.6	-1.8	-2.1	-2.7

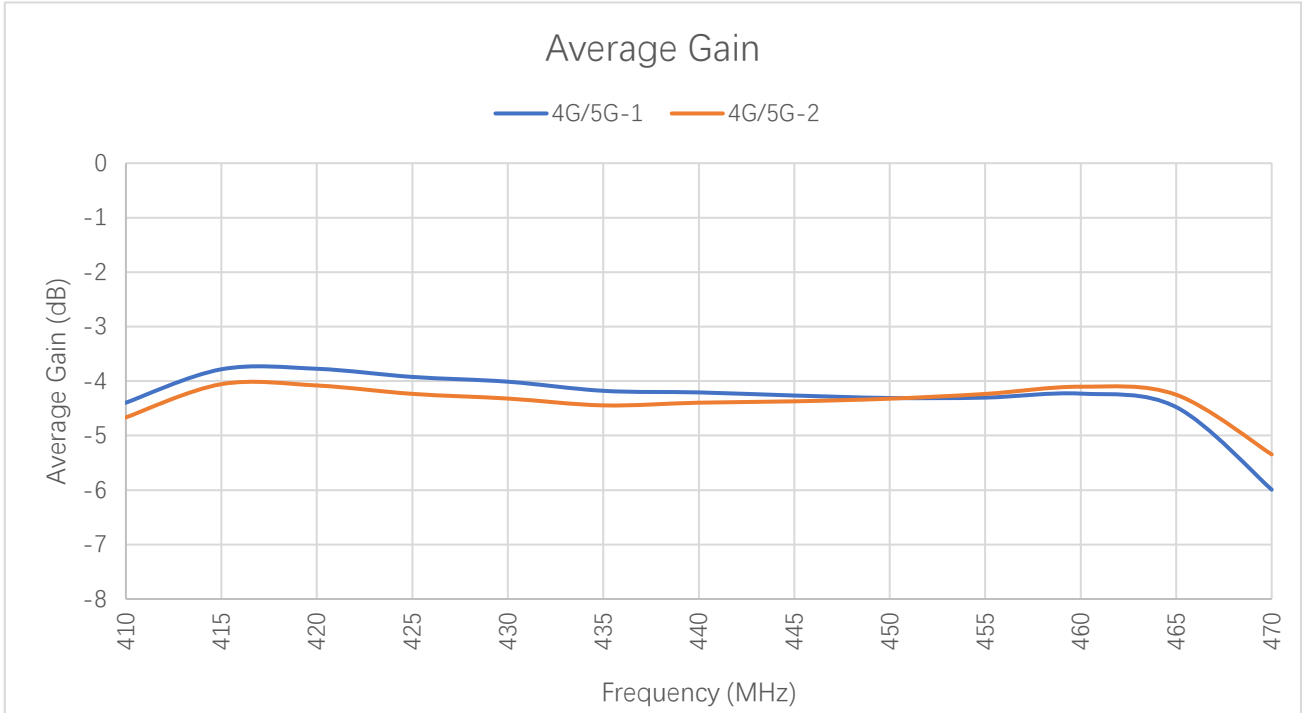

Average Gain (dB)

Frequency (MHz)	410	420	430	440	450	460	470
4G/5G-1	-4.4	-3.8	-4.0	-4.2	-4.3	-4.2	-6.0
4G/5G-2	-4.7	-4.1	-4.3	-4.4	-4.3	-4.1	-5.3

3.2.3 Peak Gain

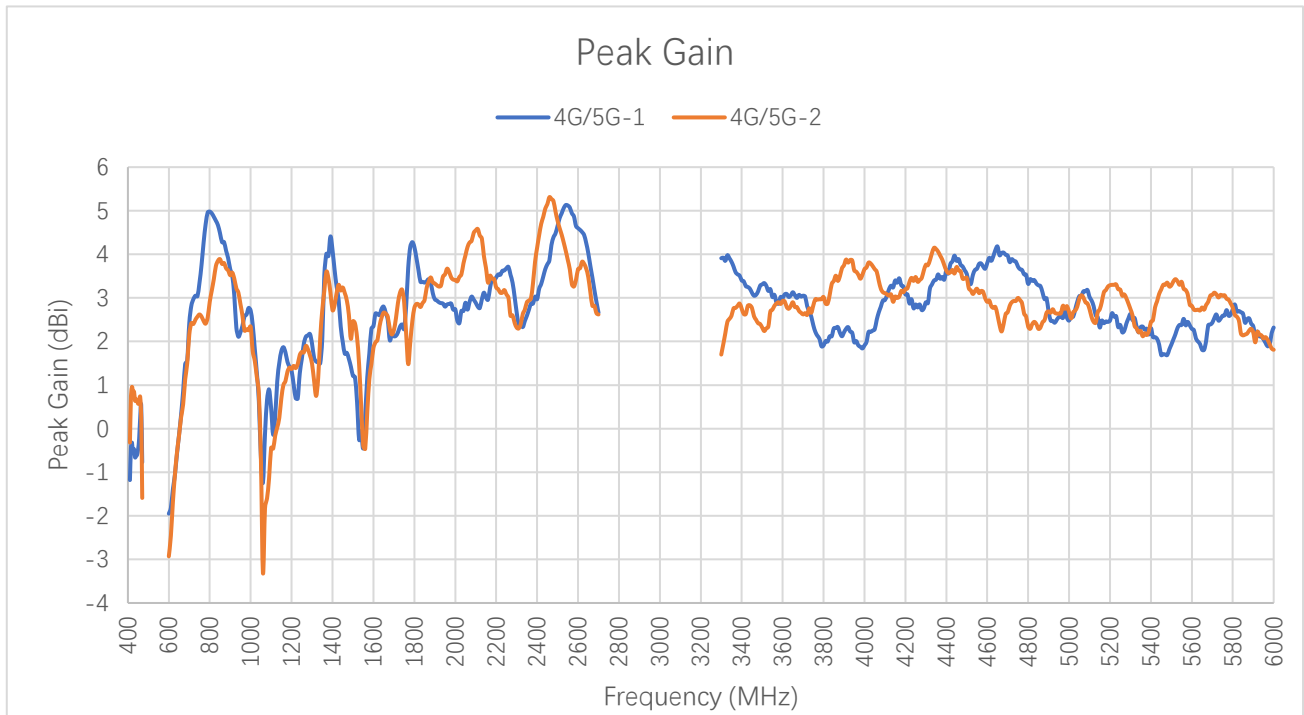

Peak Gain (dBi)

Frequency (MHz)	600	630	710	830	900	960	1440	1710	1740	1880
4G/5G-1	-2.0	-1.1	2.8	4.8	3.7	2.4	2.0	2.1	2.4	3.4
4G/5G-2	-2.9	-1.1	2.4	3.7	3.5	2.6	3.2	2.5	3.2	3.5
Frequency (MHz)	1950	2140	2350	2450	2600	3600	4700	5000	5500	6000
4G/5G-1	2.8	3.1	2.6	3.8	4.6	3.0	4.0	2.5	1.9	2.3
4G/5G-2	-2.9	-1.1	2.4	3.7	3.5	2.6	3.2	2.5	3.2	-2.9

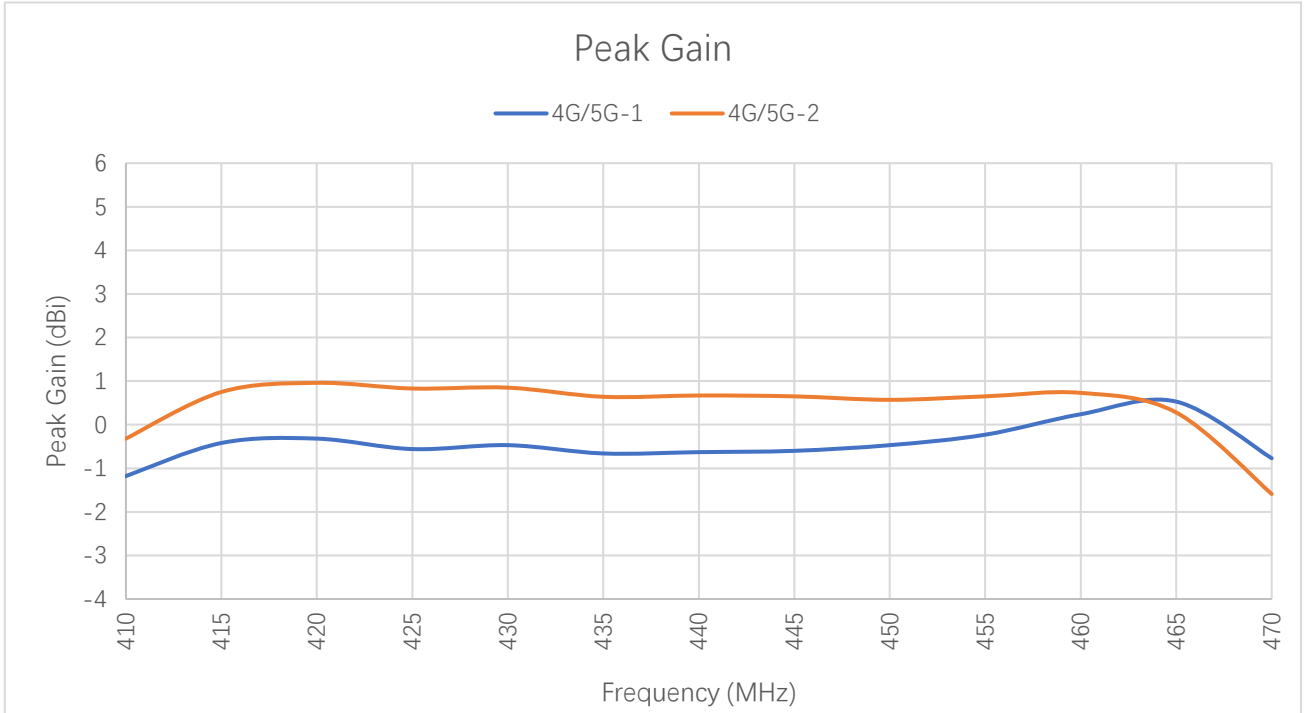

Peak Gain (dBi)

Frequency (MHz)	410	420	430	440	450	460	470
4G/5G-1	-1.2	-0.3	-0.5	-0.6	-0.5	0.2	-0.8
4G/5G-2	-0.3	1.0	0.9	0.7	0.6	0.7	-1.6

3.2.4 3D & 2D Radiation Pattern

- Test Status: Free space
- Test Chamber: FS-S-1

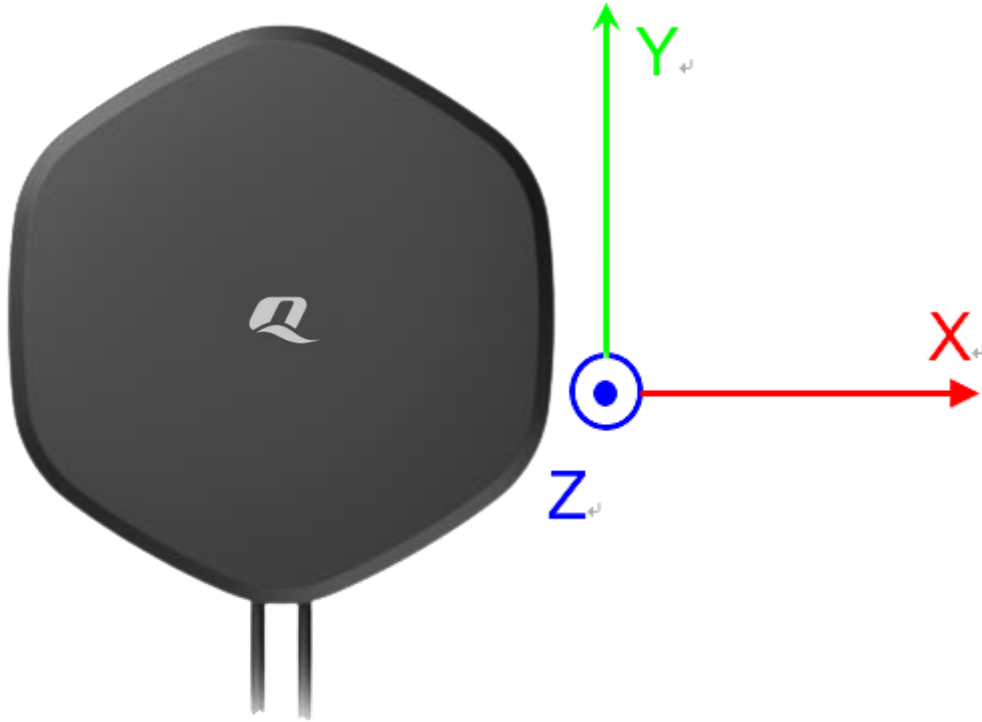

● **4G/5G-1**

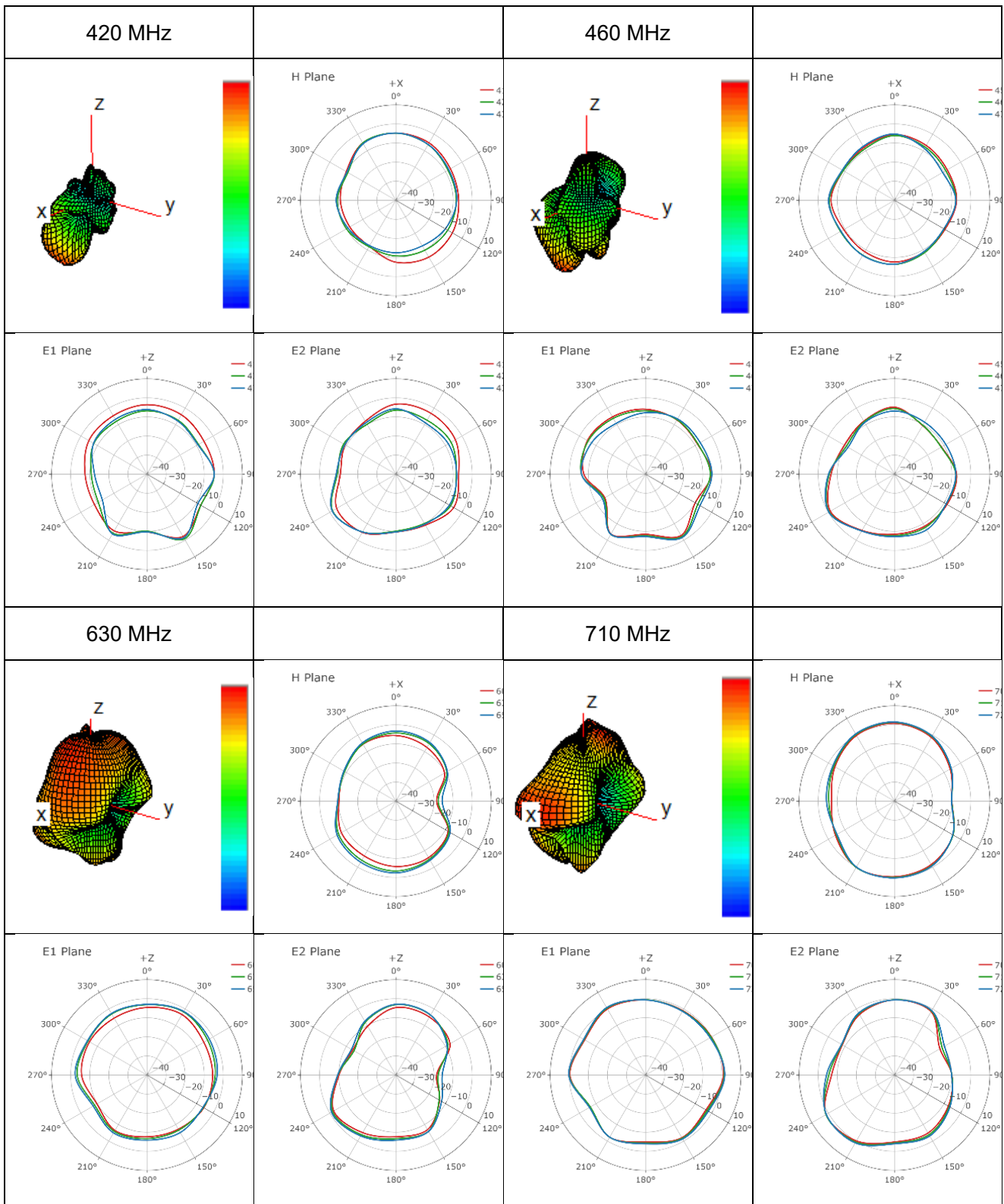

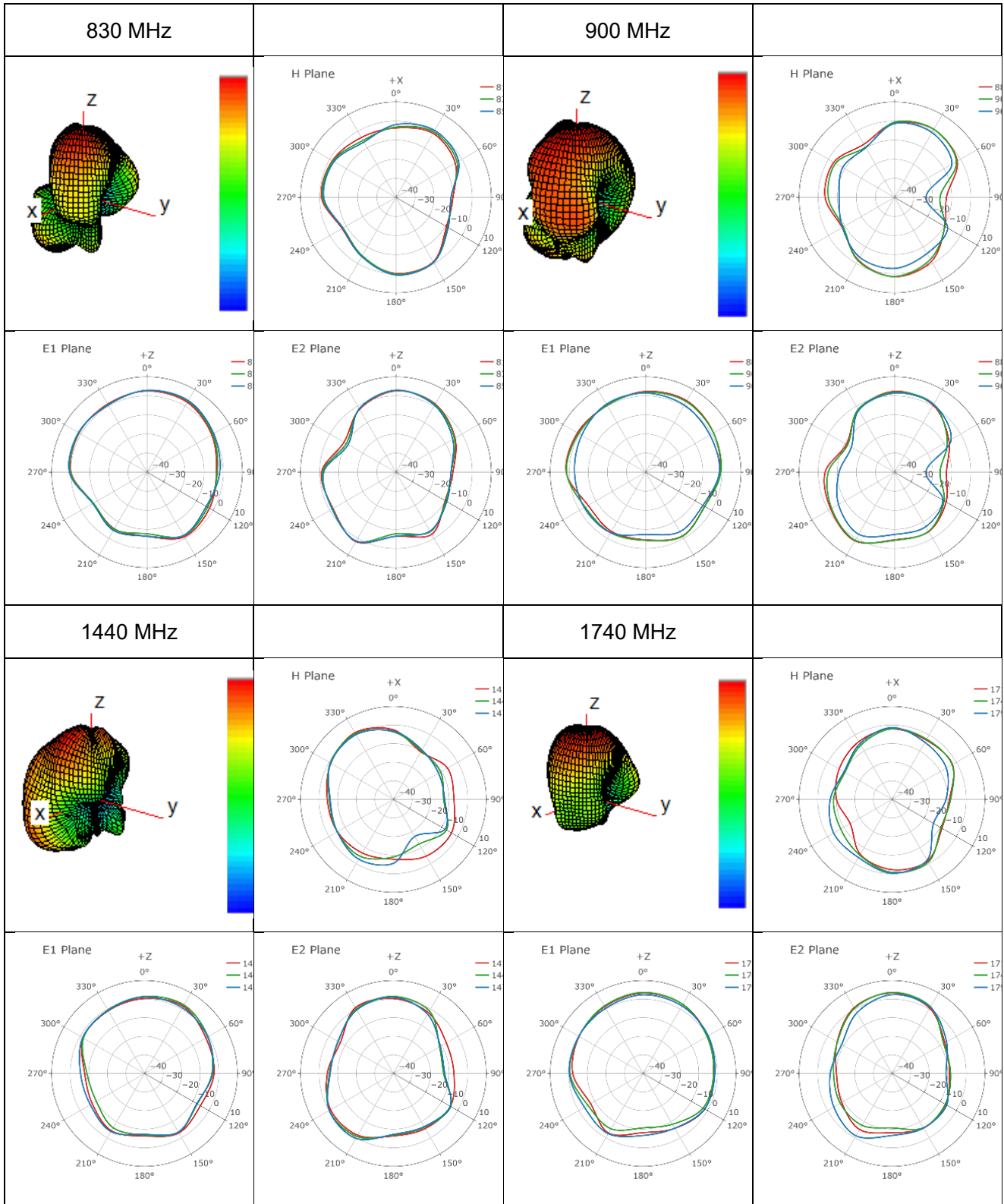

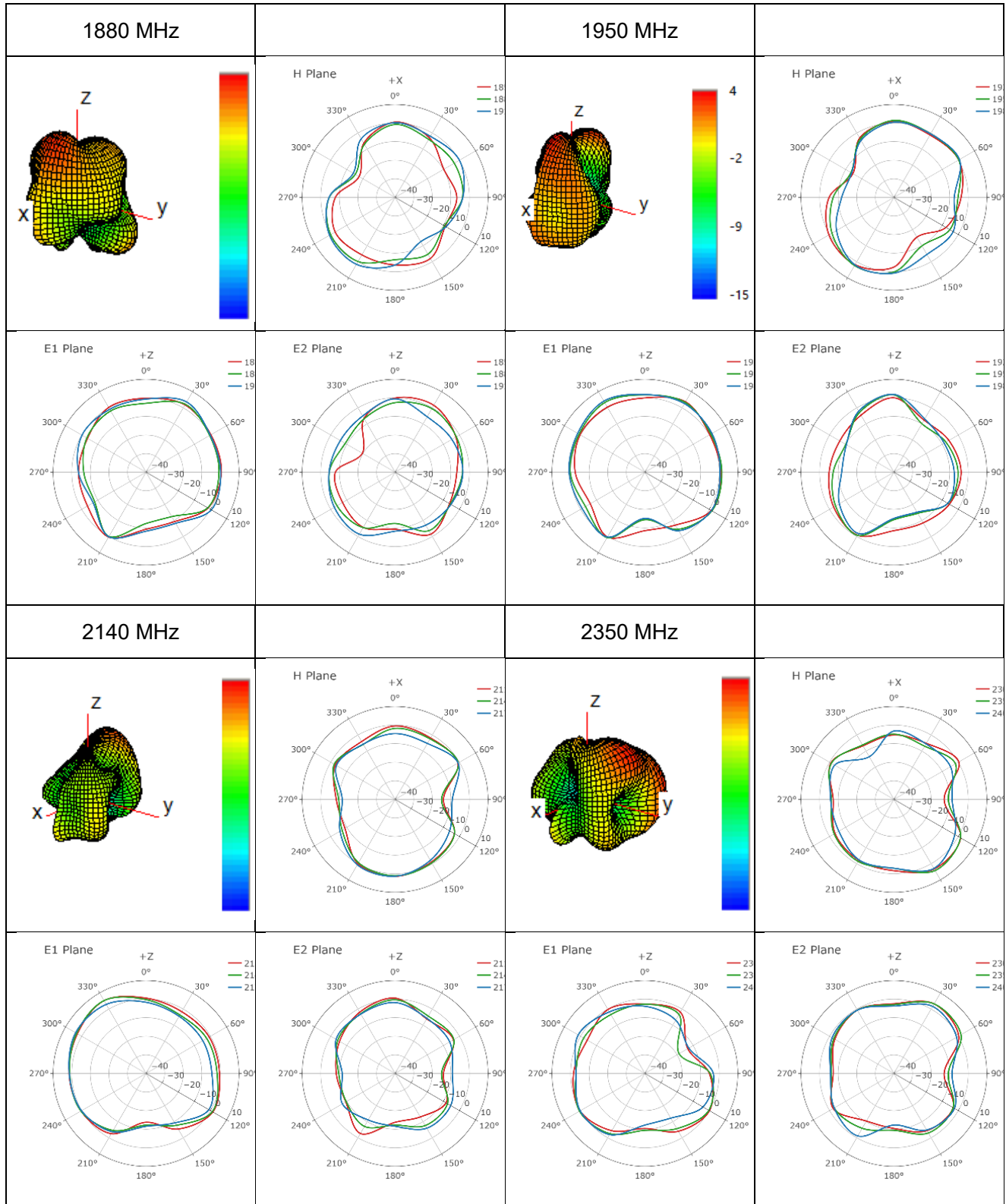

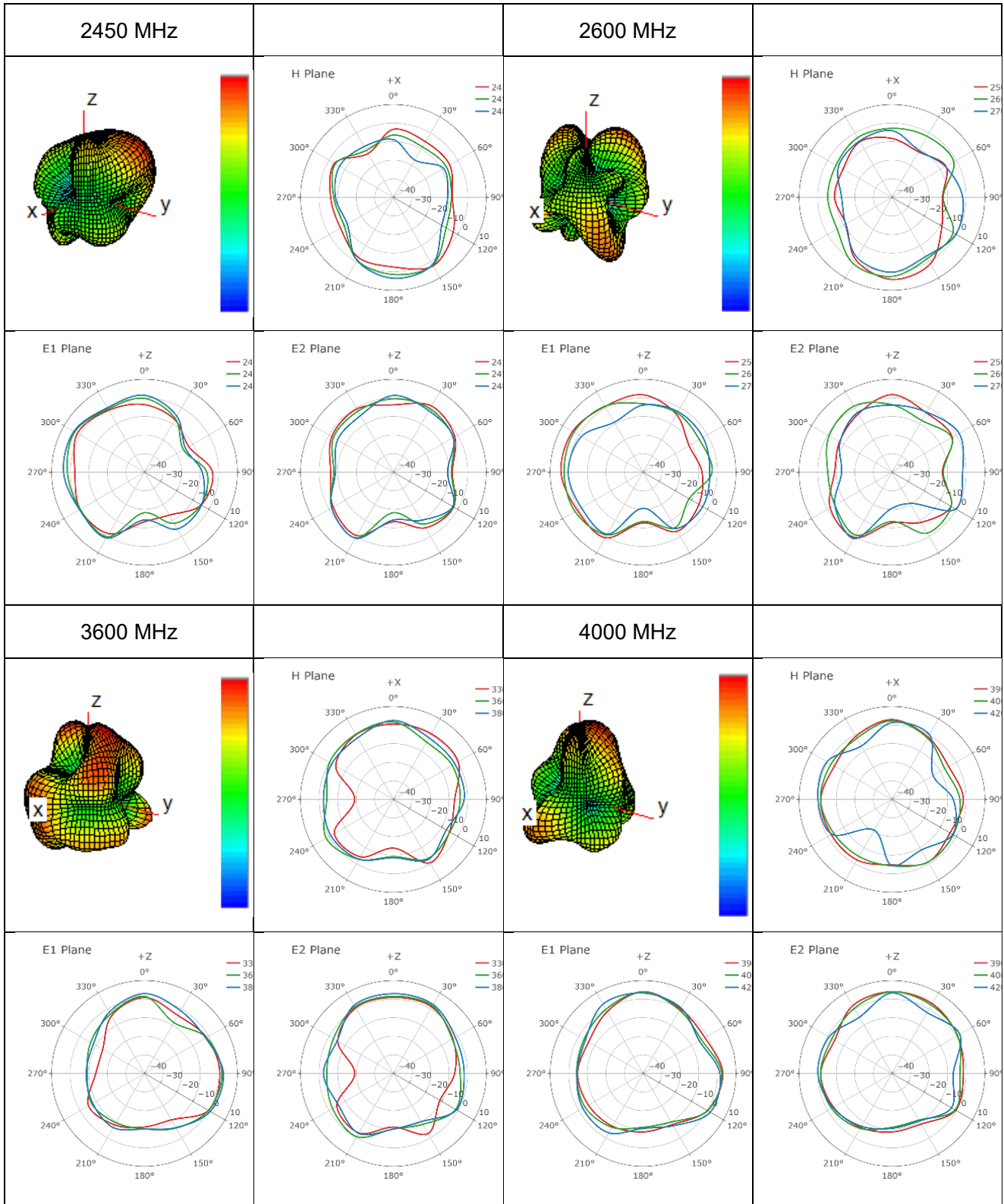

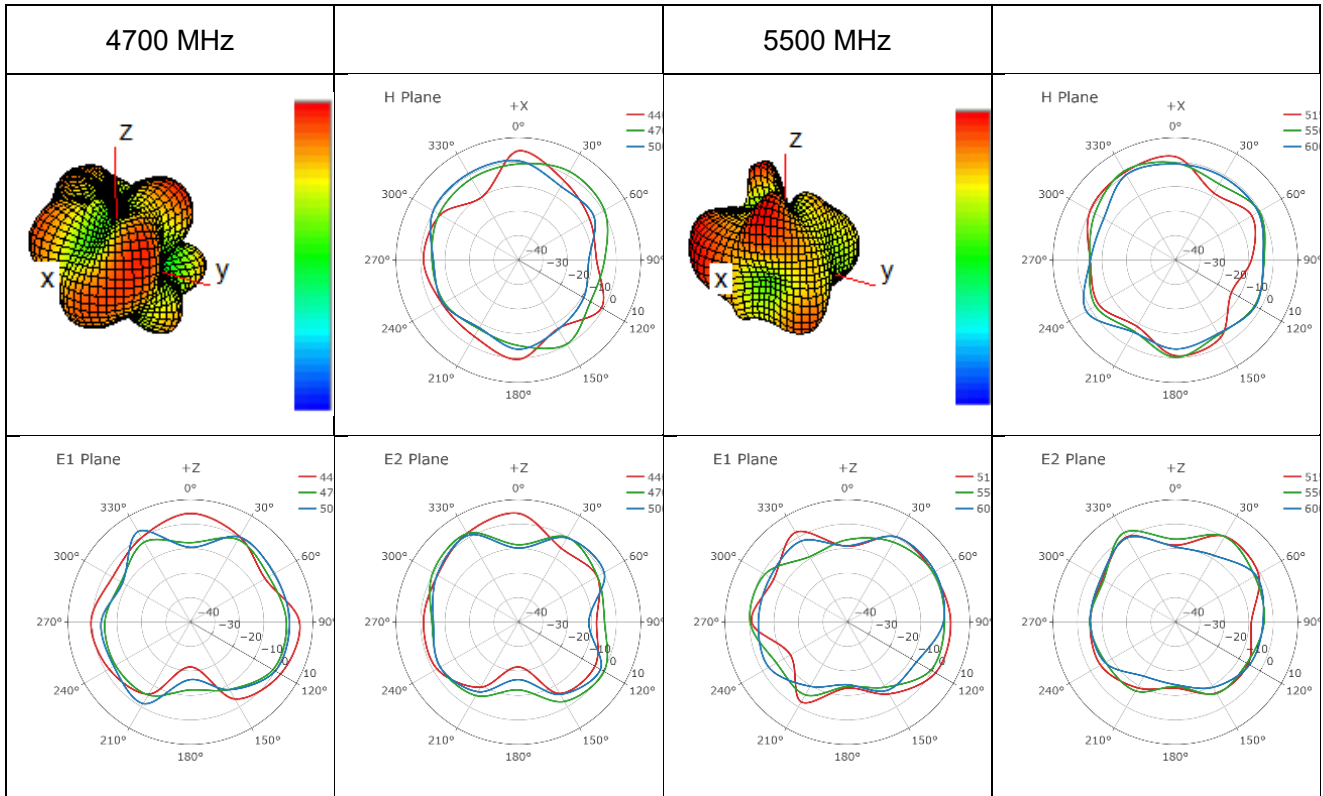

● **4G/5G-2**

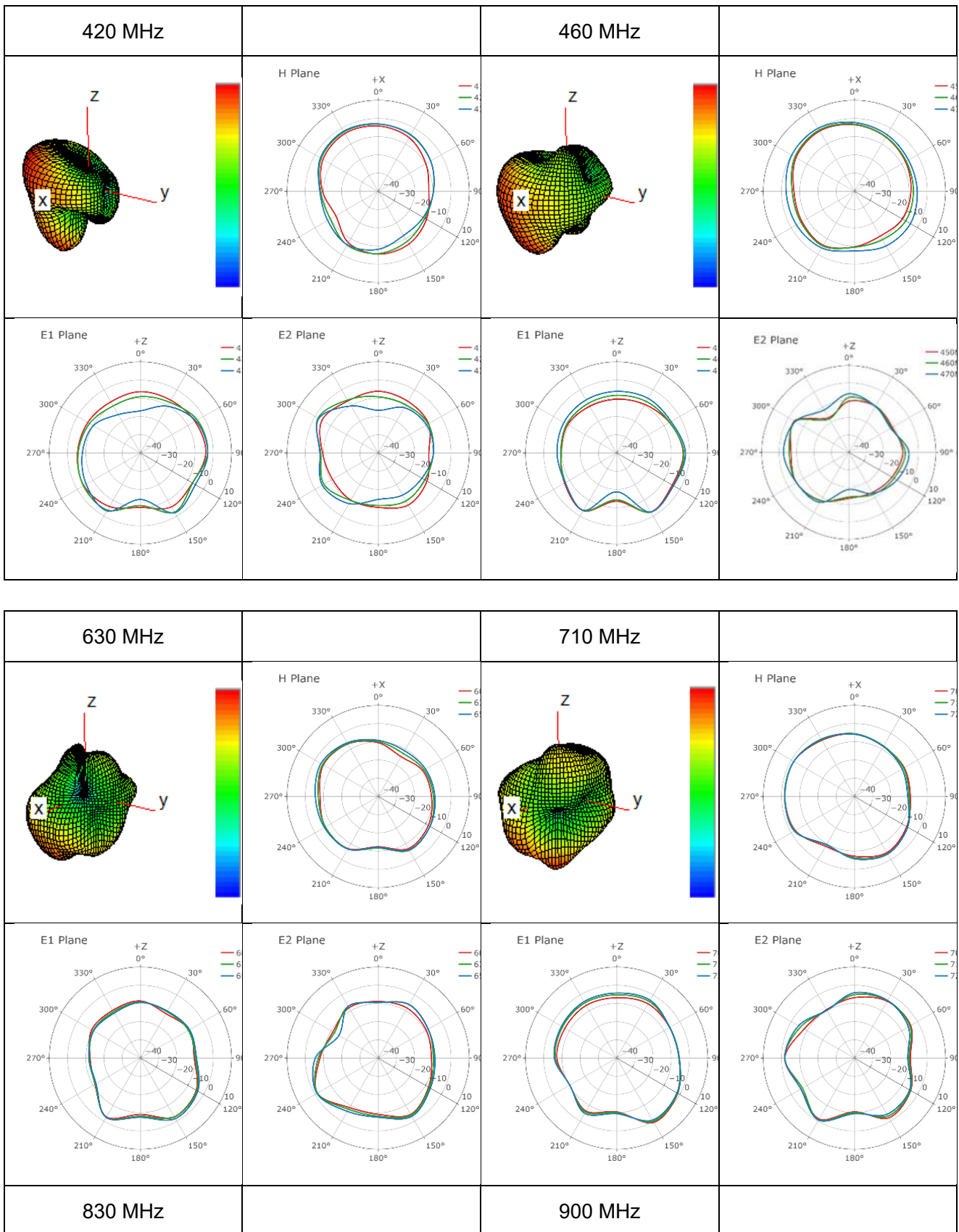

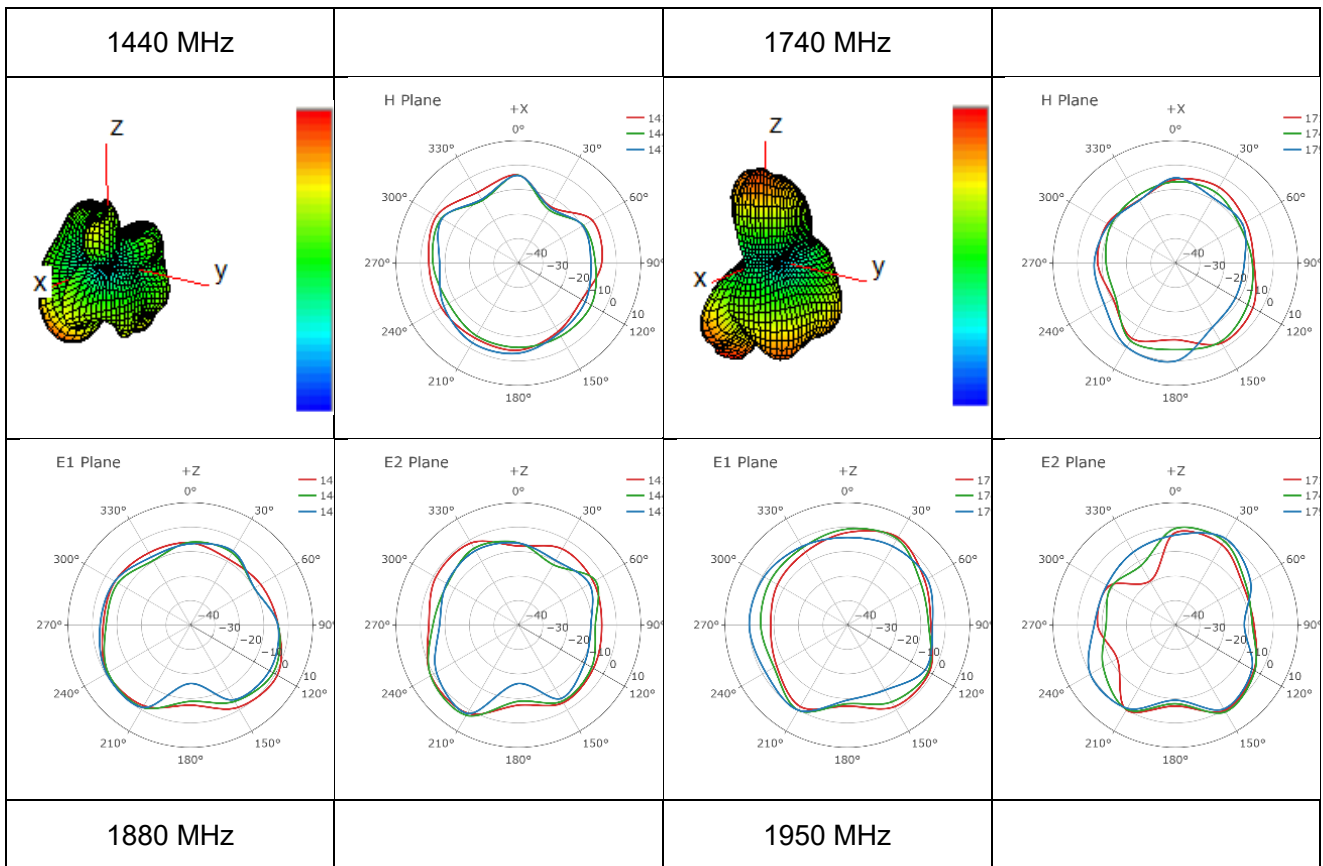
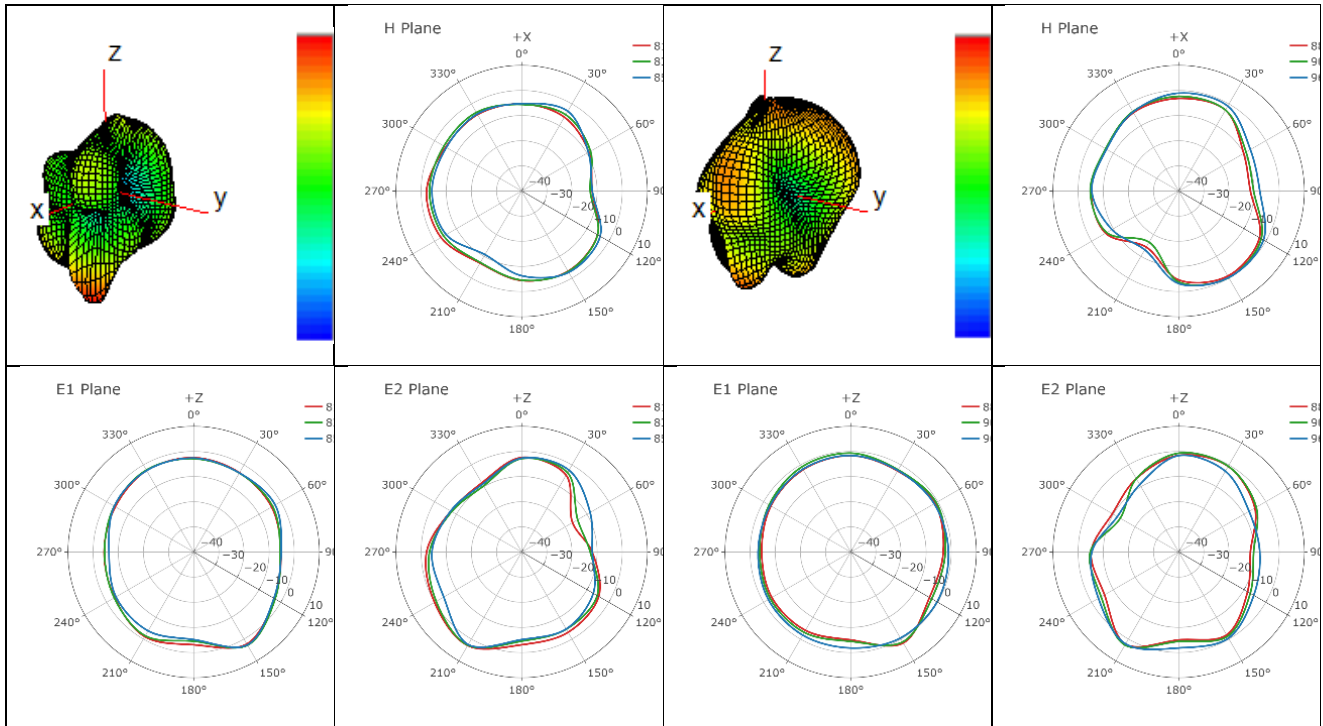

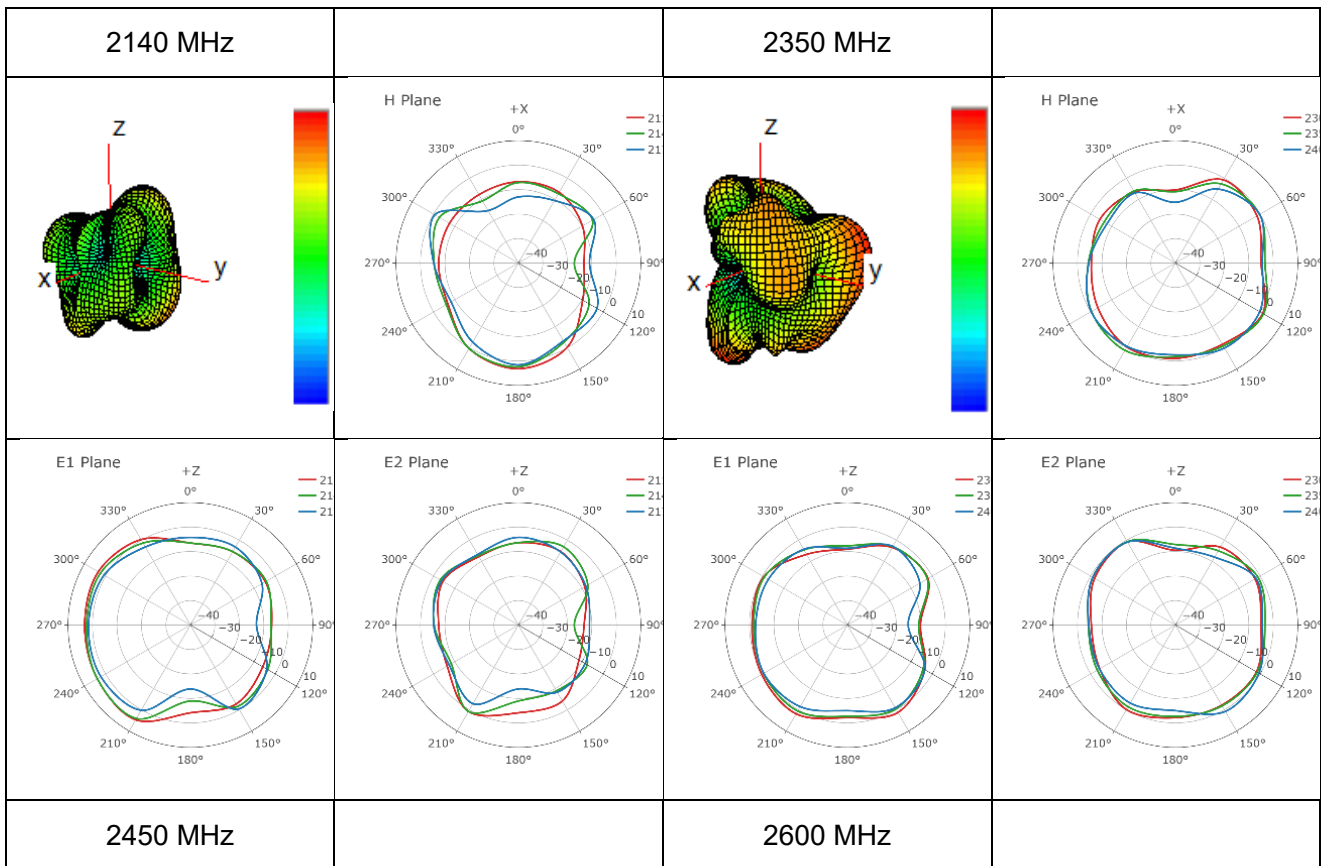
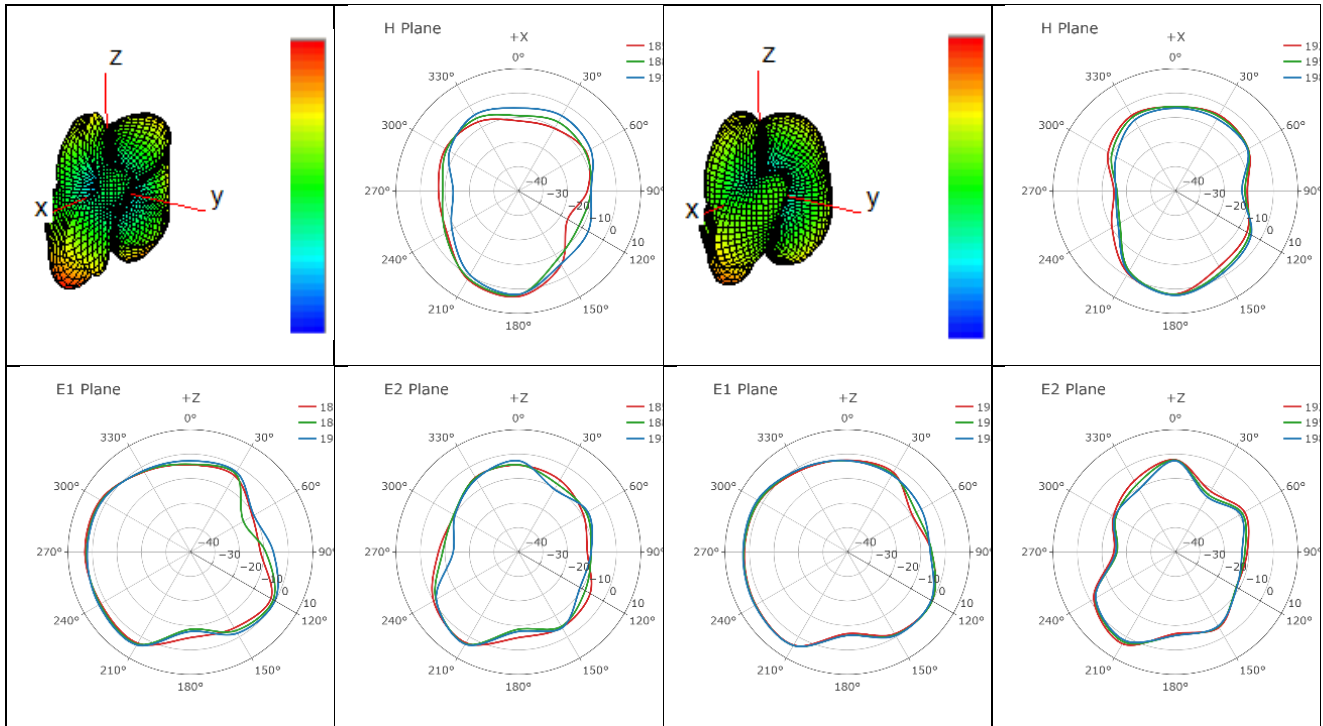

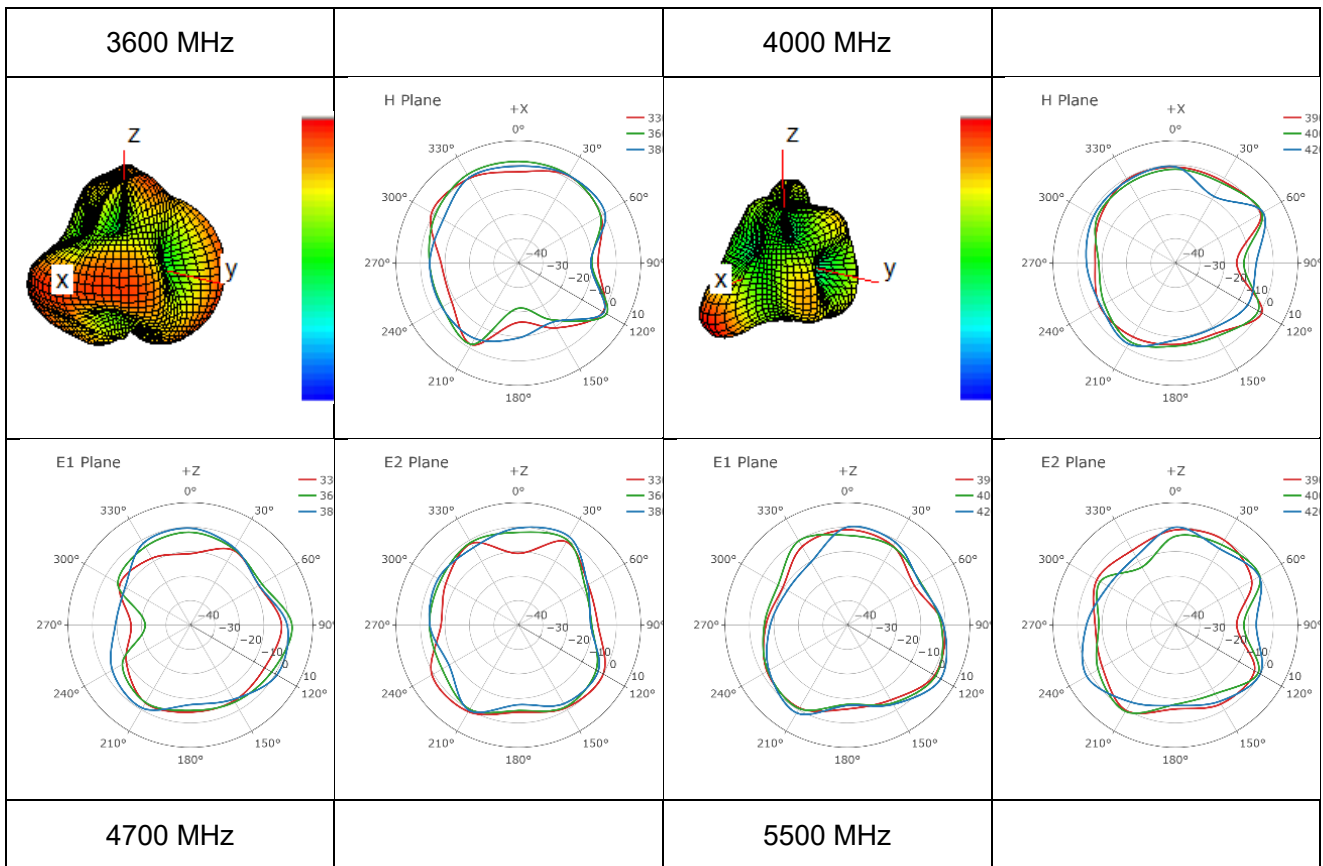
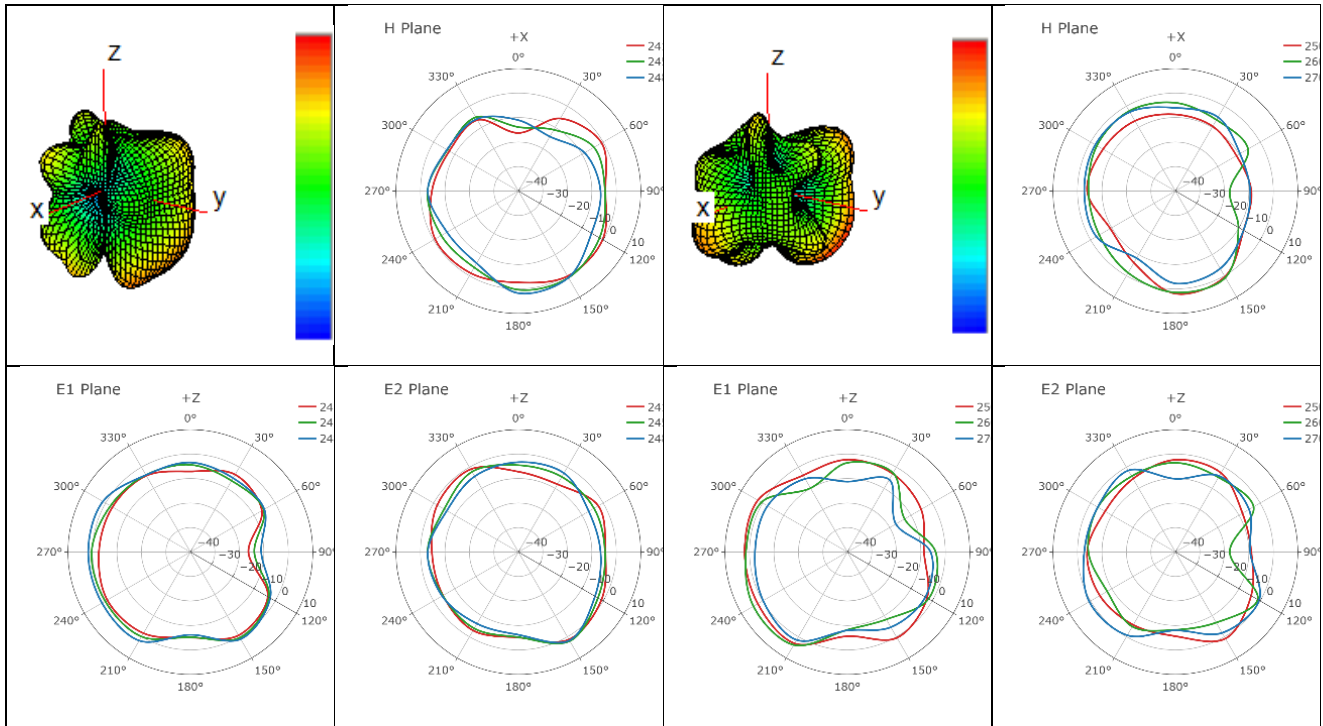

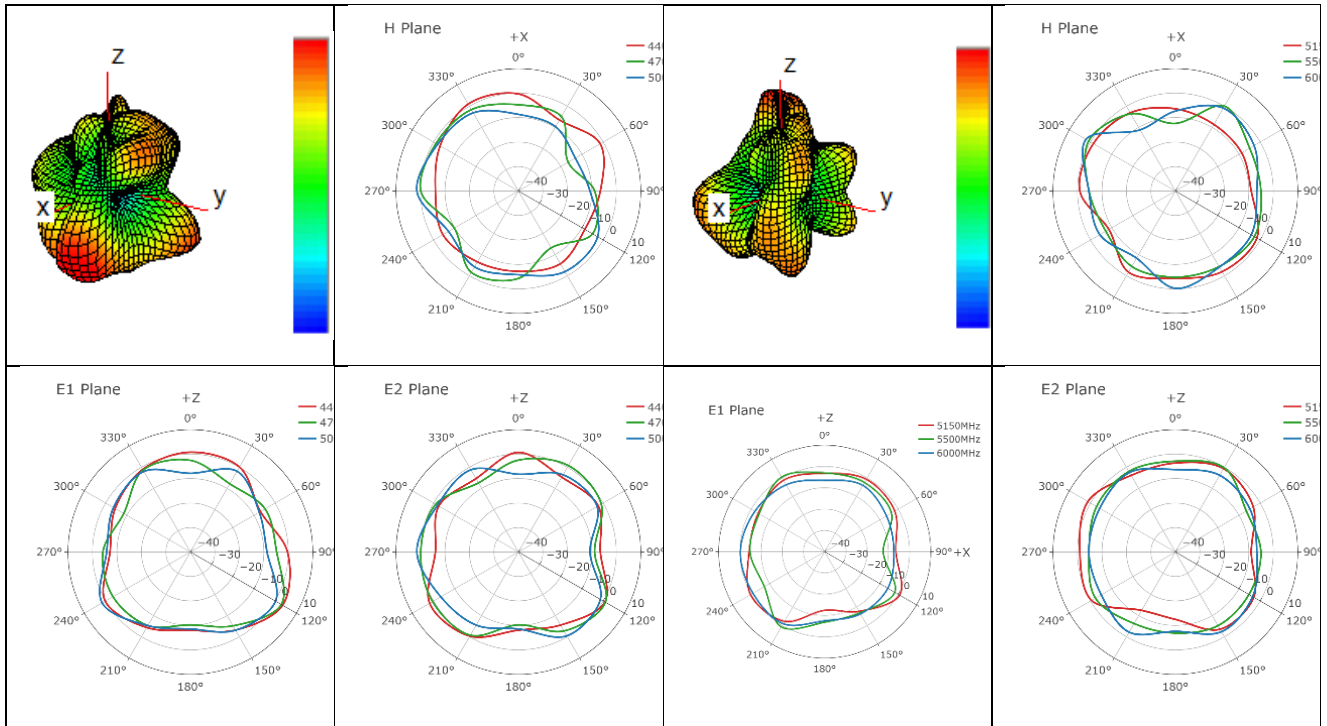

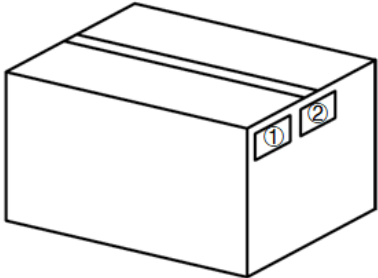

4 Packaging

Step	Packaging Picture / 2D Picture	Description
1		Product drawing
2		1 antenna product in a bubble bag. (1 Antenna / Bubble Bag)
3		<p>Each knife card slot holds 1 product, and one layer of knife cards holds 4 products. One carton box has three layers of knife cards. (4 Antennas / One Layer of Knife Cards) (Three Layers of Knife Cards / Carton Box) (12 Antennas / Carton Box)</p> <p>Estimated quantity Products that cannot fill the entire carton box are packed in a suitable size carton box. Carton Size: L × W × H = 470 × 450 × 385 mm</p>
4		<p>Position for Attaching Labels</p> <ul style="list-style-type: none"> ① Carton Label ② Quality Label

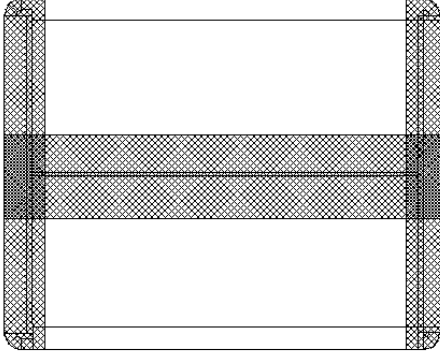
5		Sealing Cartons H-shaped sealing cartons
Note	The initial packaging method described above is for reference only, and the final actual packaging method shall be subject to the actual shipping packaging.	

5 Installation

- The YEMX223J1A has the following three installation methods:

1. Pole mounting installation

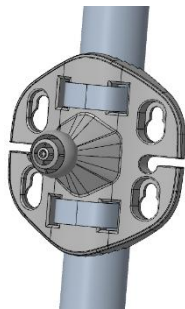

Step 1: Thread the metal clamp through the assembly holes of the pole and base, and pre-tighten the screws.

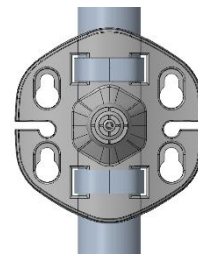

Step 2: Move the base to the desired position on the pole, lock the screws with a screwdriver, and secure the clamp.

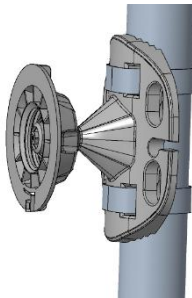

Step 3: Insert the plastic nut into the ball head base.

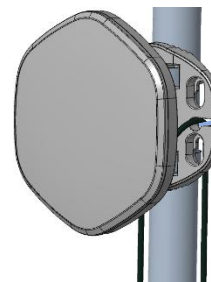

Cable slot

Step 4: Press the antenna body into the ball head base, adjust the antenna to the desired angle, tighten the nut, and place the cable into the corresponding cable slot.

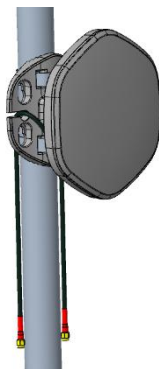

Step 5: Complete the installation.

2. Wall mounting installation

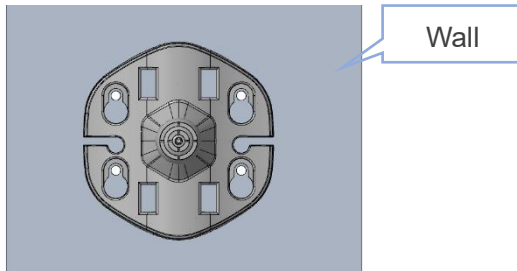

Step 1: Mark the appropriate positions on the wall with the four mounting holes on the base, and drill four holes with a diameter of 6 mm and a depth of 25 mm.

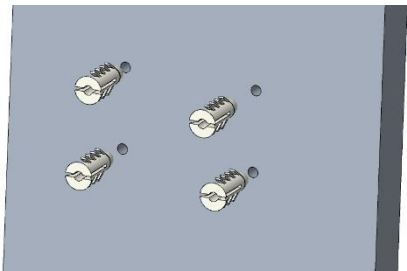

Step 2: Insert the expansion tubes into the four holes.

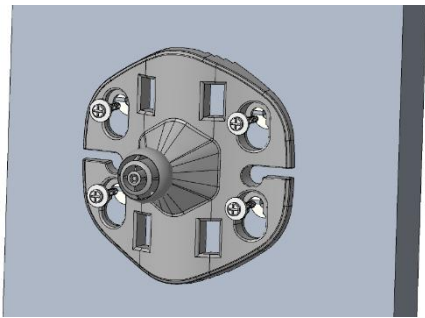

Step 3: Lock the base into the expansion tubes with screw components.

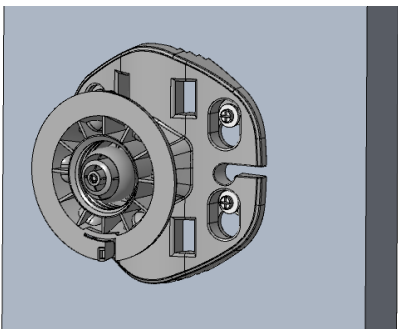

Step 4: Insert the plastic nut into the base head base.

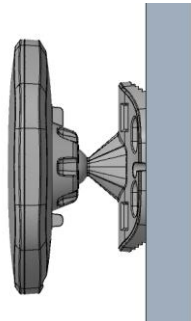

Step 5: Press the antenna body into the ball head base, adjust the antenna to the desired angle, and then tighten the nut.

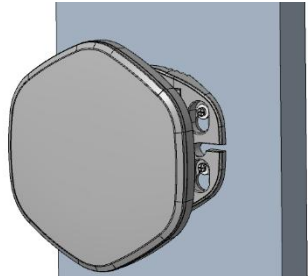

Step 6: Complete the installation.

3. Suction cup mounting installation

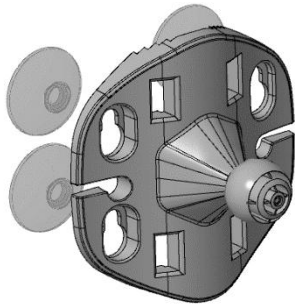

Installation surface

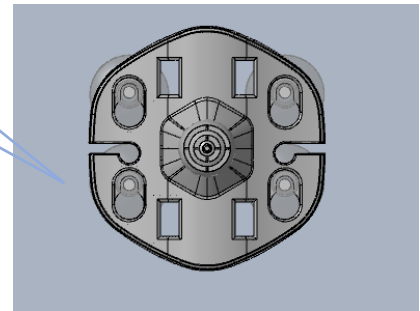

Step 1: Install the suction cup into the corresponding mounting holes around the base.
Attention: Check if the suction cup is deformed. If there is obvious deformation, soak the suction cup in warm water at around 60 degrees Celsius to eliminate the deformation and restore it to its normal state.

Step 2: Align the base with the safety installation surface, press the suction cup firmly to eliminate internal air, and fix the base.
Attention: The installation surface should be a smooth surface, such as a smooth glass surface, smooth mirror surface, or smooth ceramic tile. Before installation, the installation surface needs to be cleaned to ensure that there is no dust or other contaminants.

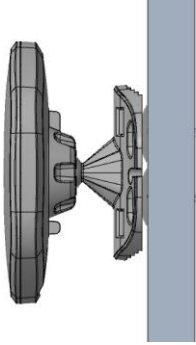
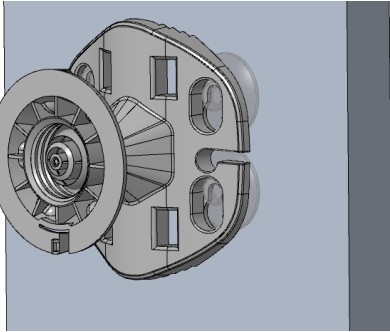

Step 3: Insert the plastic nut into the base ball head.

Step 4: Press the antenna body into the ball head base, adjust the antenna to the desired angle, and then tighten the nut.

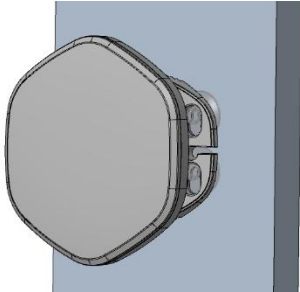

Step 5: Complete the installation.

Installation Instructions			
Mark	Frequency (MHz)	Tube Color	Technology
4G/5G-1	410–6000 MHz	Red	5G/4G/3G/2G
4G/5G-2	410–6000 MHz	Red	5G/4G/3G/2G

Contact Us

At Quectel, our aim is to provide timely and comprehensive services to our customers. If you require any assistance, please contact our headquarters:

Quectel Wireless Solutions Co., Ltd.

Building 5, Shanghai Business Park Phase III (Area B), No.1016 Tianlin Road, Minhang District, Shanghai 200233, China

Tel: +86 21 5108 6236

Email: info@quectel.com

Or our local offices. For more information, please visit:

<http://www.quectel.com/support/sales.htm>.

For technical support, or to report documentation errors, please visit:

<http://www.quectel.com/support/technical.htm>.

Or email us at: support@quectel.com.

Legal Notices

We offer information as a service to you. The provided information is based on your requirements and we make every effort to ensure its quality. You agree that you are responsible for using independent analysis and evaluation in designing intended products, and we provide reference designs for illustrative purposes only. Before using any hardware, software or service guided by this document, please read this notice carefully. Even though we employ commercially reasonable efforts to provide the best possible experience, you hereby acknowledge and agree that this document and related services hereunder are provided to you on an “as available” basis. We may revise or restate this document from time to time at our sole discretion without any prior notice to you.

Use and Disclosure Restrictions

License Agreements

Documents and information provided by us shall be kept confidential, unless specific permission is granted. They shall not be accessed or used for any purpose except as expressly provided herein.

Copyright

Our and third-party products hereunder may contain copyrighted material. Such copyrighted material shall not be copied, reproduced, distributed, merged, published, translated, or modified without prior written consent. We and the third party have exclusive rights over copyrighted material. No license shall be granted or conveyed under any patents, copyrights, trademarks, or service mark rights. To avoid ambiguities, purchasing in any form cannot be deemed as granting a license other than the normal non-exclusive, royalty-free license to use the material. We reserve the right to take legal action for noncompliance with abovementioned requirements, unauthorized use, or other illegal or malicious use of the material.

Trademarks

Except as otherwise set forth herein, nothing in this document shall be construed as conferring any rights to use any trademark, trade name or name, abbreviation, or counterfeit product thereof owned by Quectel or any third party in advertising, publicity, or other aspects.

Third-Party Rights

This document may refer to hardware, software and/or documentation owned by one or more third parties (“third-party materials”). Use of such third-party materials shall be governed by all restrictions and obligations applicable thereto.

We make no warranty or representation, either express or implied, regarding the third-party materials, including but not limited to any implied or statutory, warranties of merchantability or fitness for a particular purpose, quiet enjoyment, system integration, information accuracy, and non-infringement of any third-party intellectual property rights with regard to the licensed technology or use thereof. Nothing herein constitutes a representation or warranty by us to either develop, enhance, modify, distribute, market, sell, offer for sale, or otherwise maintain production of any our products or any other hardware, software, device, tool, information, or product. We moreover disclaim any and all warranties arising from the course of dealing or usage of trade.

Privacy Policy

To implement module functionality, certain device data are uploaded to Quectel's or third-party's servers, including carriers, chipset suppliers or customer-designated servers. Quectel, strictly abiding by the relevant laws and regulations, shall retain, use, disclose or otherwise process relevant data for the purpose of performing the service only or as permitted by applicable laws. Before data interaction with third parties, please be informed of their privacy and data security policy.

Disclaimer

- a) We acknowledge no liability for any injury or damage arising from the reliance upon the information.
- b) We shall bear no liability resulting from any inaccuracies or omissions, or from the use of the information contained herein.
- c) While we have made every effort to ensure that the functions and features under development are free from errors, it is possible that they could contain errors, inaccuracies, and omissions. Unless otherwise provided by valid agreement, we make no warranties of any kind, either implied or express, and exclude all liability for any loss or damage suffered in connection with the use of features and functions under development, to the maximum extent permitted by law, regardless of whether such loss or damage may have been foreseeable.
- d) We are not responsible for the accessibility, safety, accuracy, availability, legality, or completeness of information, advertising, commercial offers, products, services, and materials on third-party websites and third-party resources.

Copyright © Quectel Wireless Solutions Co., Ltd. 2025. All rights reserved.

Revision History

Version	Date	Author	Note
-	2023-06-19	Mordecai Liu/ Hart Hu/ David Liu/ Bunny Zhang	Creation of the document
1.0	2023-06-19	Mordecai Liu/ Hart Hu/ David Liu/ Bunny Zhang	First official release
1.1	2024-01-30	Hart Hu/ Vinnie Liu	<ol style="list-style-type: none"> Added Housing UV Resistant (Chapter 1.2). Updated the drawing (Chapter 2).
1.2	2024-03-28	Hart Hu/ Vinnie Liu	<ol style="list-style-type: none"> Added impact protection (IK) rating (Chapter 1.2). Updated the drawing (Chapter 2). Added the installation method (Chapter 5).
1.3	2024-11-05	Bill Mo	<ol style="list-style-type: none"> Updated the overview. Updated Chapter 2. Deleted Chapter 5.
1.4	2024-12-31	Bill Mo	Added the installation methods (Chapter 5).
2.0	2025-07-01	Mordecai Liu/ Bill Mo/ Riva Ren/ Rainey Liao	Numerous changes were made to this document. It should be read in its entirety.
2.1	2025-09-19	Jason Long	Updated drawing (Chapter 2).

QUECTEL

www.quectel.com