



Antenna Datasheet

Product OC: YECT012G3AM

Version: 1.0

Date: 2025-07-21

Status: Released

Product Name: 4G Terminal Mount External Dipole Antenna

Key Features:

Frequency Band: 698–960 MHz, 1710–2690 MHz

Dimensions: 13 mm × 15.6 mm × 130 mm

Efficiency: Up to 67.0 % (EVB)

RoHS and REACH Compliant

Overview

YECT012G3AM is a 4G external antenna measuring 135 mm × 15.6 mm × 13 mm. This ultra-wide-band 4G antenna provides broad coverage from 698–960 MHz ,1710–2690 MHz whilst offering backward-compatibility to support 4G/3G and 2G networks as well as LTE Cat-M and narrowband IoT (NB-IoT). The antenna is terminated with IPEX MHF 1 connector via one cable. Ideal for applications where the antenna is required to be discrete, this low profile, terminal mount omni-directional antenna is easy to install with maximum durability assured thanks to its PC+ABS enclosure.

The antenna is designed as dipole type to work with various GND plane sizes or in free space for ease of integration with an IPEX MHF I connector via cable for optimal positioning. The cable structure allows flexible layout when installed on end devices to avoid interference with other antennas or objects. This omni-directional antenna is ideally suited for Gateways & Routers, Smart Metering, Vending Machines, Industrial IoT, Smart Home, Connected Enterprise, offering great performance with its high gain and efficiency.

Typical applications include:

- Gateways & Routers
- Smart Metering
- Vending Machines
- Industrial IoT
- Smart Home
- Connected Enterprise

Quectel provides comprehensive antenna design support such as simulation, testing and manufacturing for custom antenna solutions to meet your specific application needs. We have regional R & D centers to offer quick response to meet your requirements. Please contact our sales & FAEs if you have any requests.

Contents

Overview.....	1
Contents.....	2
1 Specification.....	3
1.1. Electrical.....	3
1.2. Supported Bands	5
1.3. Mechanical & Environmental	7
2 Drawing	8
3 Detailed Performance	9
3.1. S-Parameter Test	9
3.1.1. VSWR.....	9
3.1.2. Return Loss	10
3.2. Radiation Performance Test.....	11
3.2.1. Efficiency	11
3.2.2. Average Gain	12
3.2.3. Peak Gain.....	13
3.2.4. 3D & 2D Radiation Pattern.....	14
3.2.4.1. Test Condition: In Free Space	14
3.2.4.2. Test Condition: On 130 mm × 130 mm EVB	19
4 Packaging	24
Contact Us.....	26
Legal Notices	27
Revision History	29

1 Specification

Test Condition: In Free Space & On 130 mm × 130 mm EVB

1.1. Electrical

Electrical	
Frequency Range	698–960 MHz, 1710–2690 MHz
Impedance	50 Ω
Polarization	Linear
Radiation Pattern	Omni-directional
Antenna Type	Dipole

Electrical – Detail												
Band	Band	B71	B12 /B13 /B28	B5 /B8 /B26	n74 /n75 /n76	B1 /B2 /B3	B40	Wi-Fi 2G	B38 /B41	B42 /B48 /n77	n79	Wi-Fi 4G
	SPEC	Freq. (MHz)	600– 700	700– 810	820– 960	1420– 1520	1700– 2170	2300– 2400	2400– 2500	2500– 2690	3300– 4200	4400– 5000
Max. VSWR	FS	-	2.1	2.4	-	1.5	1.5	1.6	1.7	-	-	-
	EVB	-	2.1	3.0	-	1.8	1.6	2.0	2.0	-	-	-
Max. Return Loss (dB)	FS	-	-9.0	-7.8	-	-14.7	-14.1	-13.2	-11.6	-	-	-
	EVB	-	-8.9	-6.0	-	-10.7	-12.6	-9.7	-9.6	-	-	-
AVG Eff. (%)	FS	-	33.3	29.7	-	44.1	52.8	50.4	53.7	-	-	-
	EVB	-	44.3	37.2	-	54.4	63.2	61.0	62.4	-	-	-
AVG AVG Gain (dB)	FS	-	-4.8	-5.3	-	-3.6	-2.8	-3.0	-2.7	-	-	-
	EVB	-	-3.6	-4.3	-	-2.7	-2.0	-2.2	-2.1	-	-	-

Max. Peak Gain (dBi)	FS	-	-0.2 (700)	1.1 (960)	-	3.6 (1920)	3.4 (2340)	2.9 (2400)	3.8 (2640)	-	-	-
	EVB	-	-0.3 (700)	0.8 (960)	-	4.1 (1920)	4.6 (2360)	4.5 (2400)	4.1 (2690)	-	-	-
VSWR		FS		≤ 2.4								
		EVB		≤ 3								
Return Loss		FS		≤ -7.8								
		EVB		≤ -6 dB								
Peak Gain		FS		≤ 3.8 dBi								
		EVB		≤ 4.6 dBi								

- FS: In Free Space.
- EVB: On 130 mm × 130 mm EVB.

1.2. Supported Bands

5G NR / LTE / LTE-Advanced / WCDMA / HSPA / HSPA+ / GPRS / GSM / NB-IoT					
Band	Frequency (MHz)	Uplink (MHz)	Downlink (MHz)	FS	EVB
1	2100	1920–1980	2110–2170	√	√
2	1900	1850–1910	1930–1990	√	√
3	1800	1710–1785	1805–1880	√	√
4	1700	1710–1755	2110–2155	√	√
5	850	824–849	869–894	√	√
7	2600	2500–2570	2620–2690	√	√
8	900	880–915	925–960	√	√
9	1800	1749.9–1784.9	1844.9–1879.9	√	√
11	1500	1427.9–1447.9	1475.9–1495.9	-	-
12	700	699–716	729–746	√	√
13	700	777–787	746–756	√	√
14	700	788–798	758–768	√	√
17	700	704–716	734–746	√	√
18	850	815–830	860–875	√	√
19	850	830–845	875–890	√	√
20	800	832–862	791–821	√	√
21	1500	1447.9–1462.9	1495.9–1510.9	-	-
22	3500	3410–3490	3510–3590	-	-
23	2100	2000–2020	2180–2200	√	√
24	1600	1626.5–1660.5	1525–1559	-	-
25	1900	1850–1915	1930–1995	√	√
26	850	814–849	859–894	√	√

28	700	703–748	758–803	√	√
31	450	452.5–457.5	462.5–467.5	-	-
34	2100	2010–2025		√	√
38	2600	2570–2620		√	√
39	1900	1880–1920		√	√
40	2300	2300–2400		√	√
41	2500	2496–2690		√	√
42	3500	3400–3600		-	-
48	3500	3550–3700		-	-
66	1700	1710–1780	2110–2200	√	√
71	600	663–698	617–652	-	-
74	1500	1427–1470	1475–1518	-	-
77	3500	3300–4200		-	-
78	3500	3300–3800		-	-
79	4500	4400–5000		-	-

1.3. Mechanical & Environmental

Mechanical	
Antenna Dimensions	13 mm × 15.6 mm × 130 mm
Material & Color	PC + ABS & Black
Connector Type	IPEX MHF 1
Cable Type & Length	Φ 1.13 Black & 200 mm
Mounting Type	Terminal
Weight	Typ. 13.5 g
Environmental	
Operation Temperature	-40 °C to +85 °C
Storage Temperature	-40 °C to +85 °C
RoHS and REACH Compliant	Yes

2 Drawing

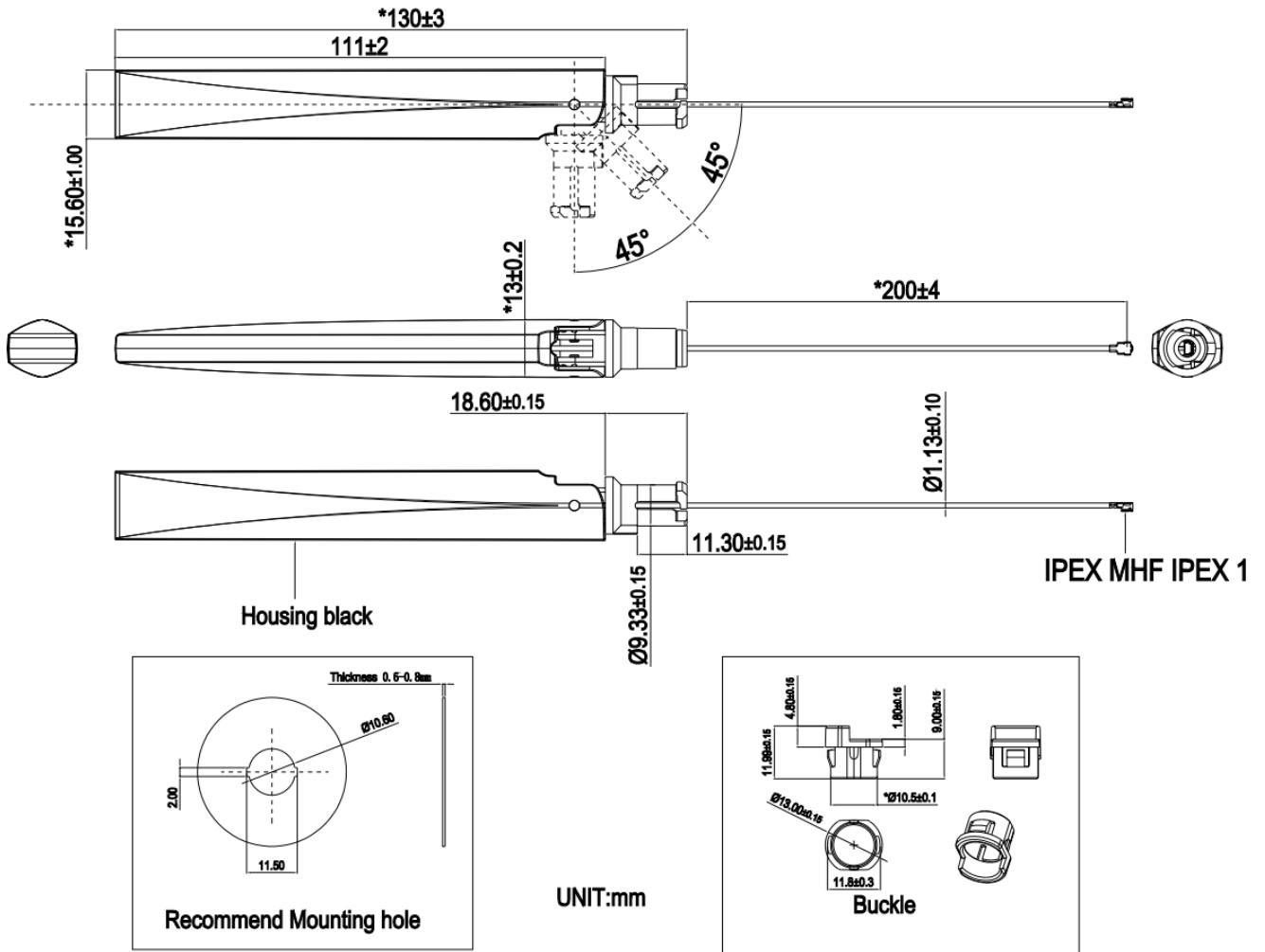

3 Detailed Performance

3.1. S-Parameter Test

3.1.1. VSWR

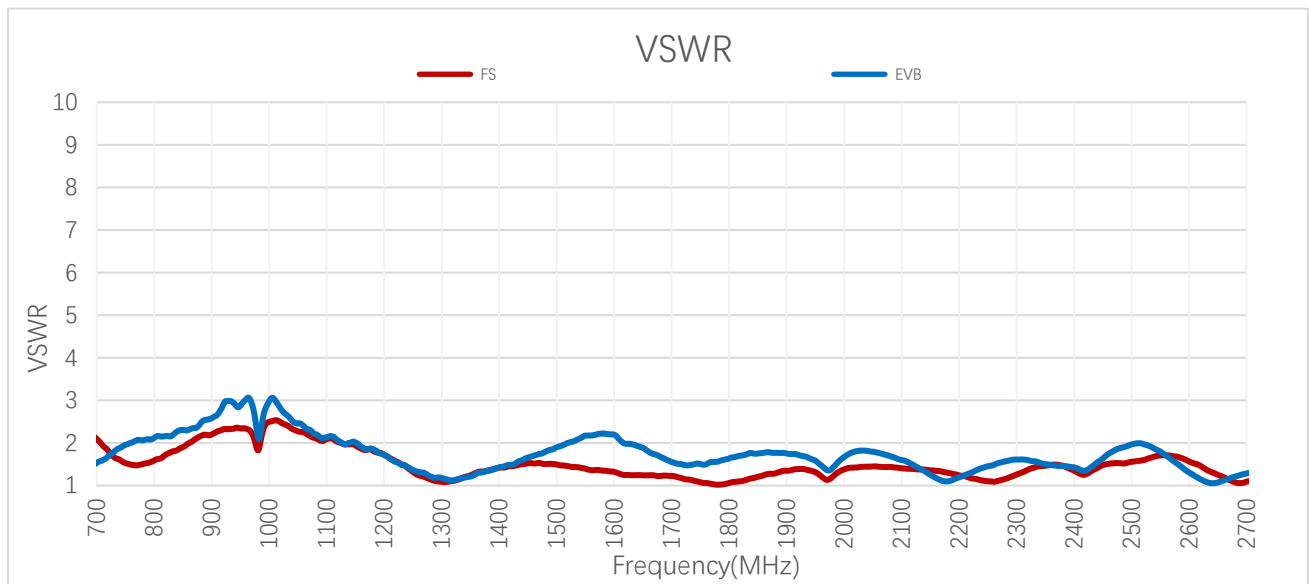

VSWR

Frequency (MHz)	600	630	710	830	900	960	1440	1710	1740	1880
FS	-	-	1.9	1.8	2.2	2.3	-	1.2	1.1	1.3
EVB	-	-	1.6	2.2	2.6	3.0	-	1.6	1.5	1.8
Frequency (MHz)	1950	2140	2350	2450	2600	2690	4700	5000	5500	6000
FS	1.4	1.4	1.5	1.5	1.6	1.1	-	-	-	-
EVB	1.6	1.3	1.5	1.7	1.3	1.3	-	-	-	-

3.1.2. Return Loss

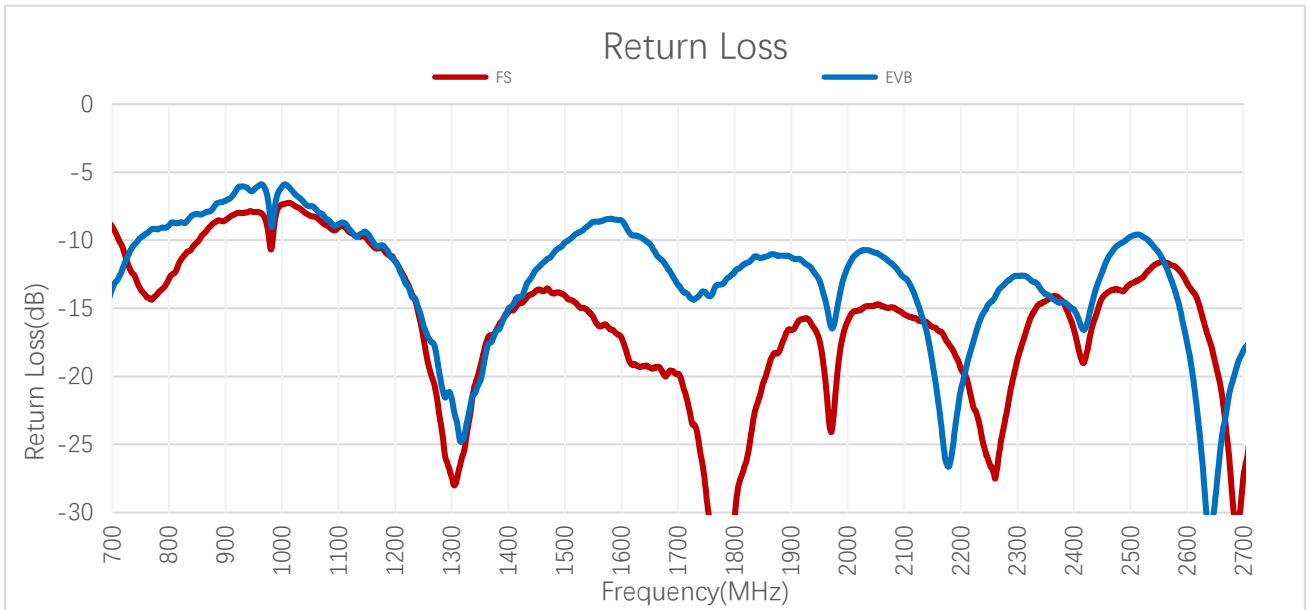

Return Loss (dB)

Frequency (MHz)	600	630	710	830	900	960	1440	1710	1740	1880
FS	-	-	-9.8	-11.0	-8.5	-7.9	-	-20.9	-25.8	-18.1
EVB	-	-	-12.8	-8.7	-7.1	-6.0	-	-13.8	-13.9	-11.1
Frequency (MHz)	1950	2140	2350	2450	2600	2690	4700	5000	5500	6000
FS	-17.3	-16.0	-14.5	-14.2	-13.1	-30.9	-	-	-	-
EVB	-12.9	-16.8	-14.0	-12.3	-17.5	-19.0	-	-	-	-

3.2. Radiation Performance Test

3.2.1. Efficiency

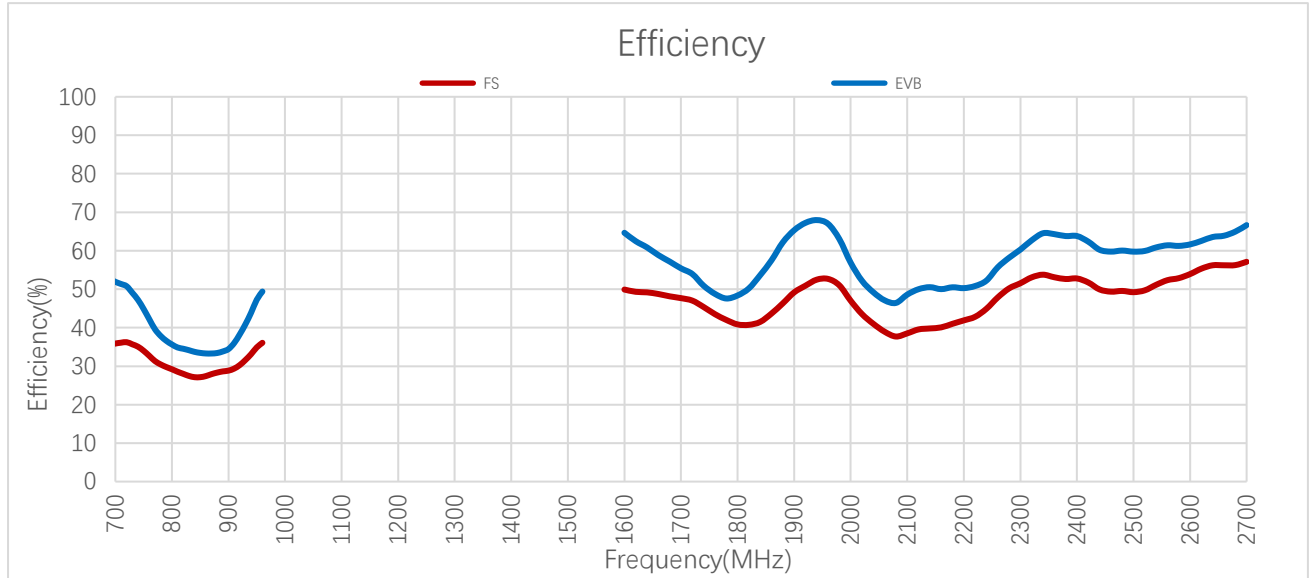

Efficiency (%)

Frequency (MHz)	600	630	710	830	900	960	1440	1710	1740	1880
FS	-	-	36.1	27.5	28.8	36.1	-	47.7	45.4	46.3
EVB	-	-	51.4	34.2	34.4	49.4	-	55.4	50.9	62.2
Frequency (MHz)	1950	2140	2350	2450	2600	2690	4700	5000	5500	6000
FS	52.5	39.8	53.8	49.4	53.9	56.3	-	-	-	-
EVB	68.0	50.5	64.5	59.8	61.6	65.0	-	-	-	-

3.2.2. Average Gain

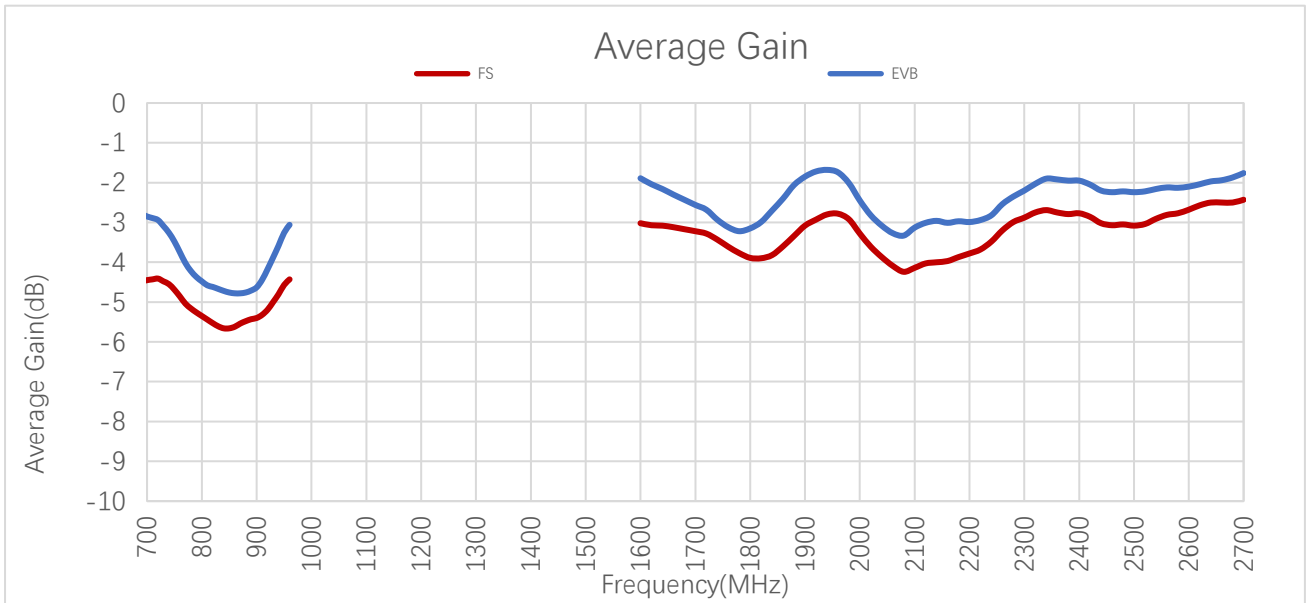

Average Gain (dB)

Frequency (MHz)	600	630	710	830	900	960	1440	1710	1740	1880
FS	-	-	-4.4	-5.6	-5.4	-4.4	-	-3.2	-3.4	-3.3
EVB	-	-	-2.9	-4.7	-4.6	-3.1	-	-2.6	-2.9	-2.1
Frequency (MHz)	1950	2140	2350	2450	2600	2690	4700	5000	5500	6000
FS	-2.8	-4.0	-2.7	-3.1	-2.7	-2.5	-	-	-	-
EVB	-1.7	-3.0	-1.9	-2.2	-2.1	-1.9	-	-	-	-

3.2.3. Peak Gain

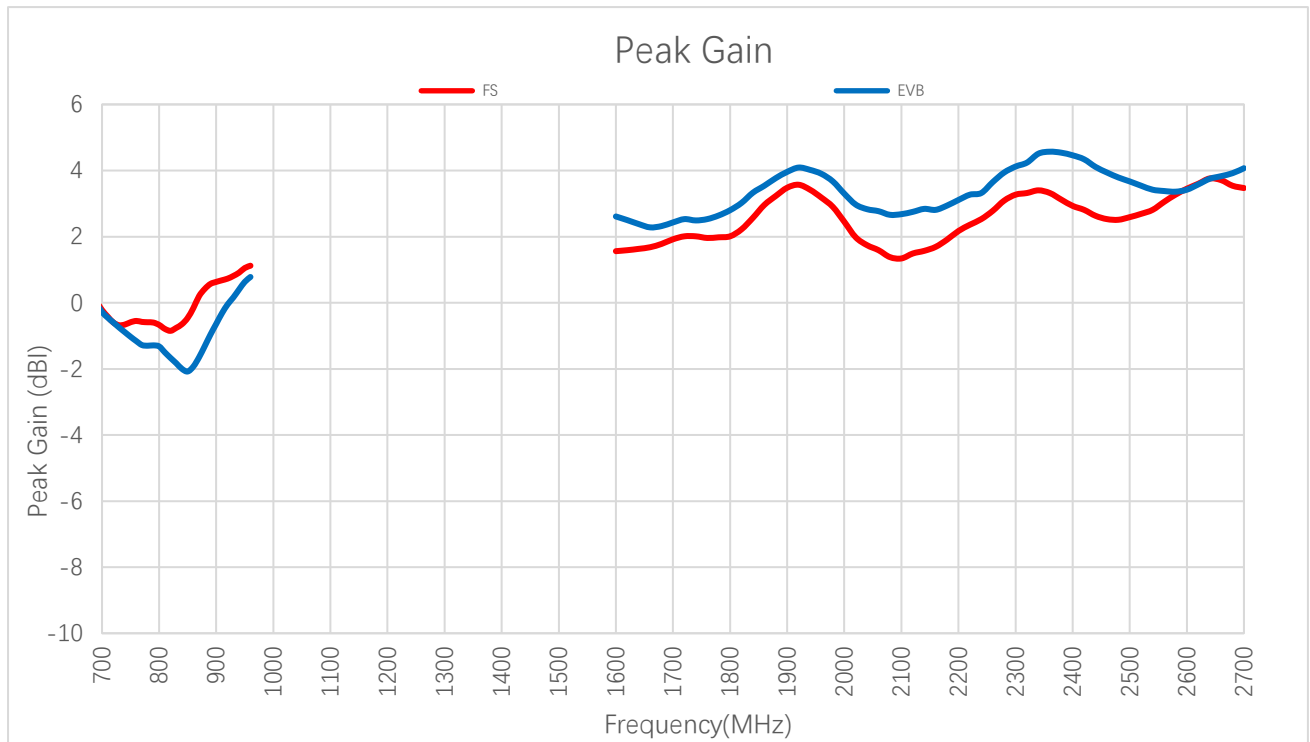

Peak Gain (dBi)

Frequency (MHz)	600	630	710	830	900	960	1440	1710	1740	1880
FS	-	-	-0.4	-0.8	0.6	1.1	-	1.9	2.0	3.2
EVB	-	-	-0.5	-1.8	-0.6	0.8	-	2.4	2.5	3.8
Frequency (MHz)	1950	2140	2350	2450	2600	2690	4700	5000	5500	6000
FS	3.4	1.6	3.4	2.5	3.5	3.5	-	-	-	-
EVB	4.0	2.8	4.5	3.9	3.4	3.9	-	-	-	-

3.2.4. 3D & 2D Radiation Pattern

3.2.4.1. Test Condition: In Free Space

- Test Chamber: HF-S-1

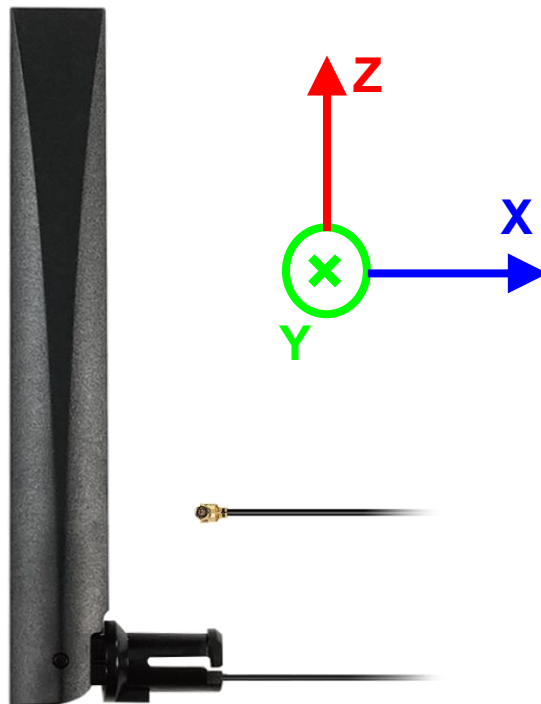

● 4G

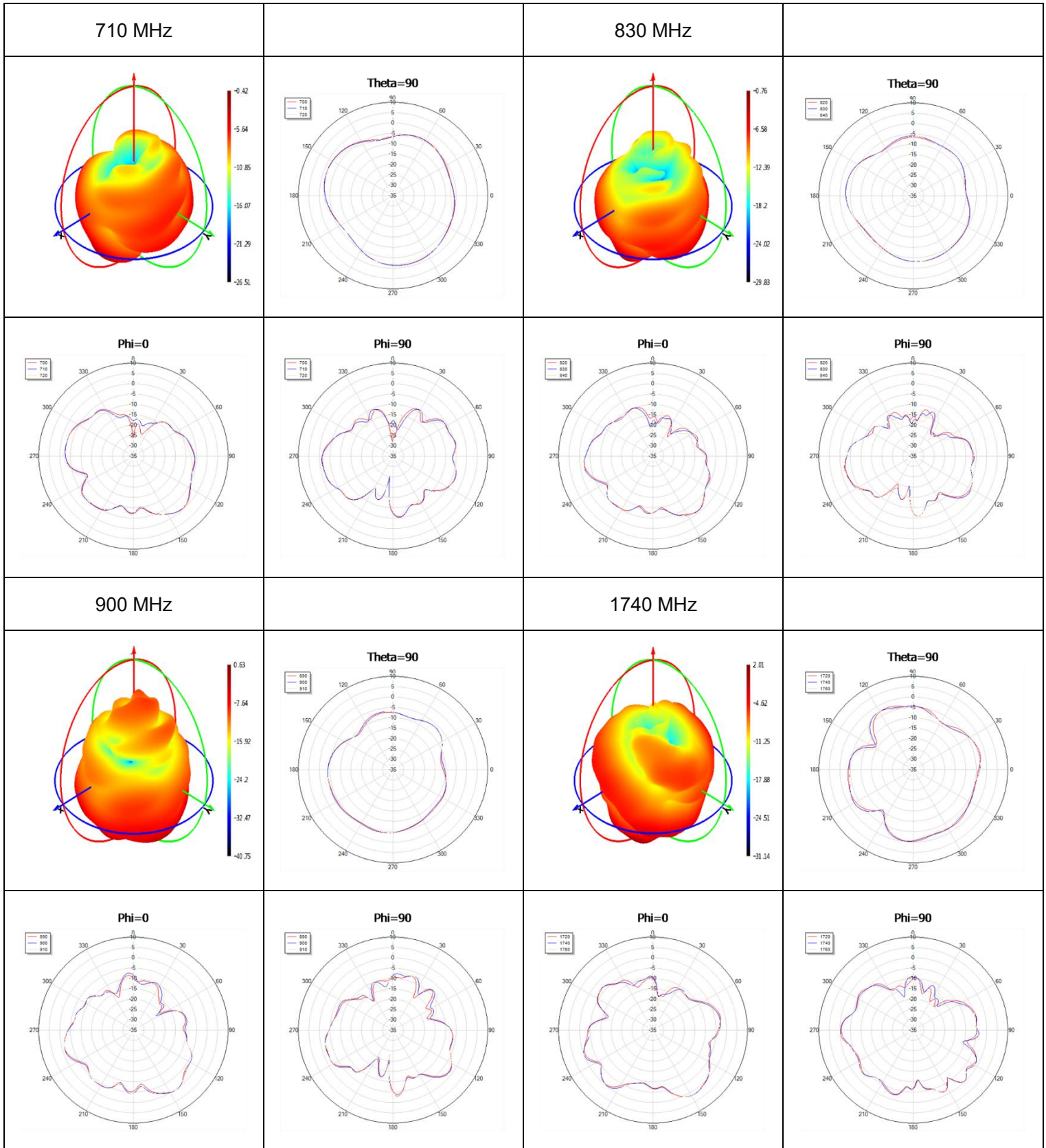

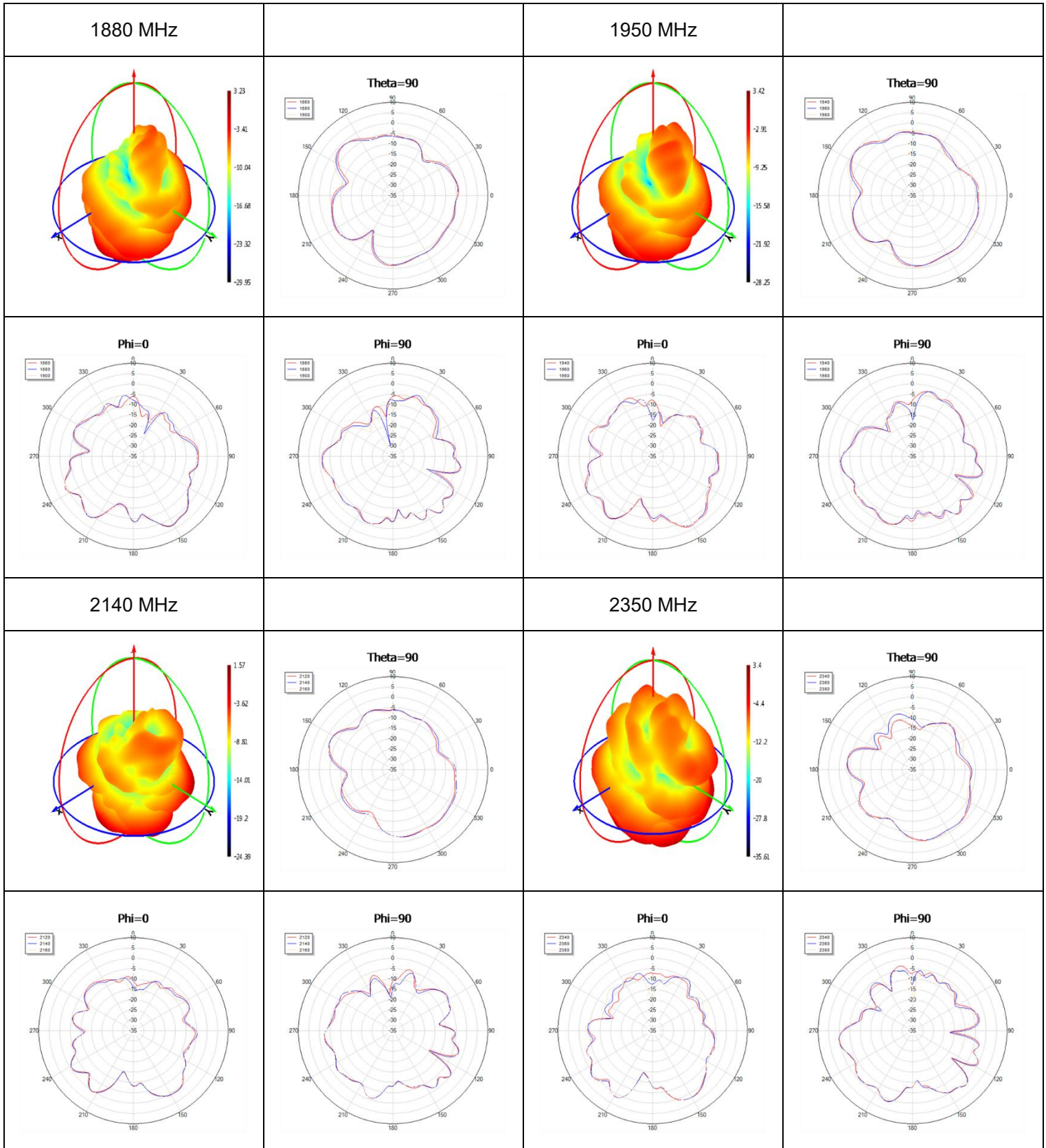

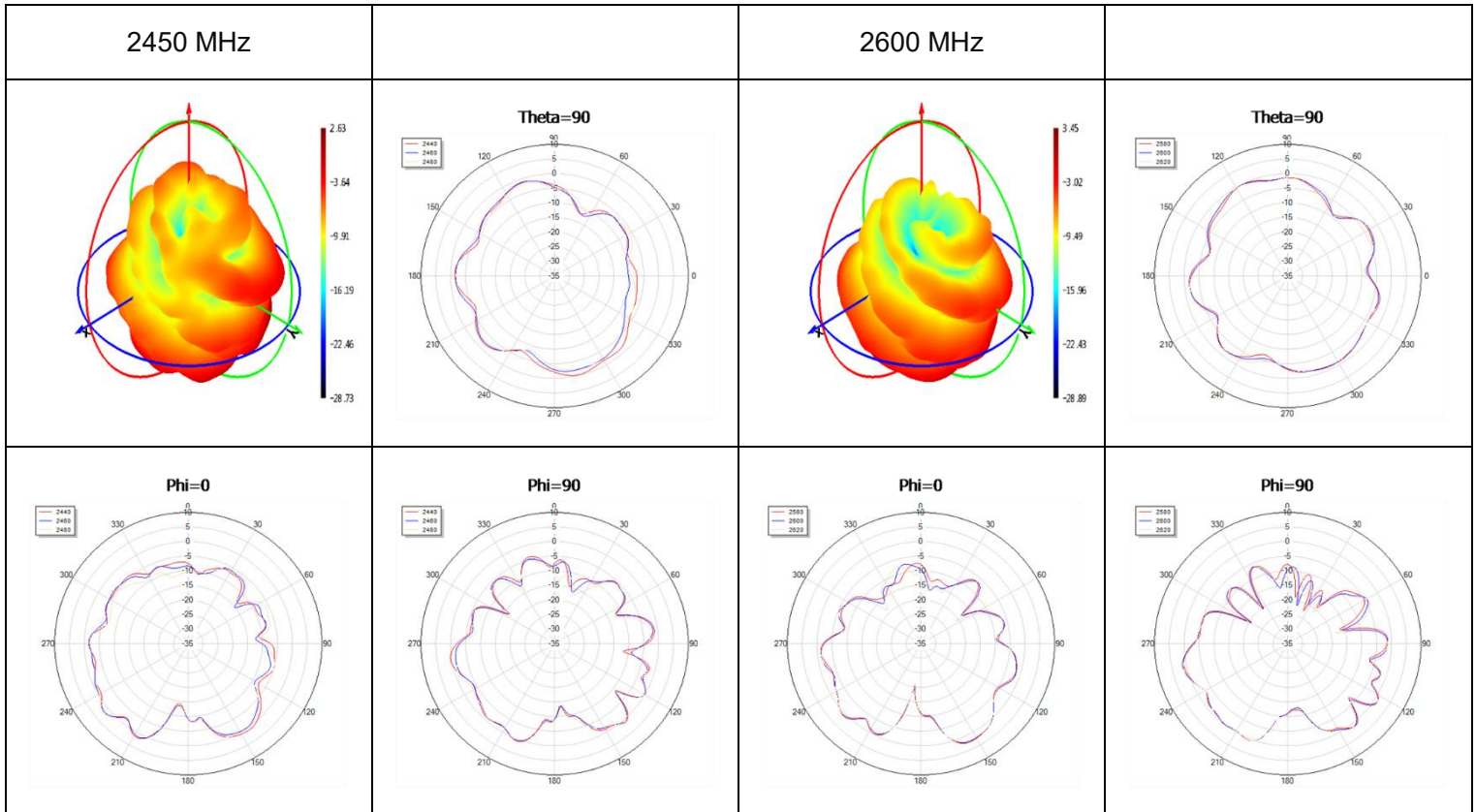

● **Max Peak Gain**

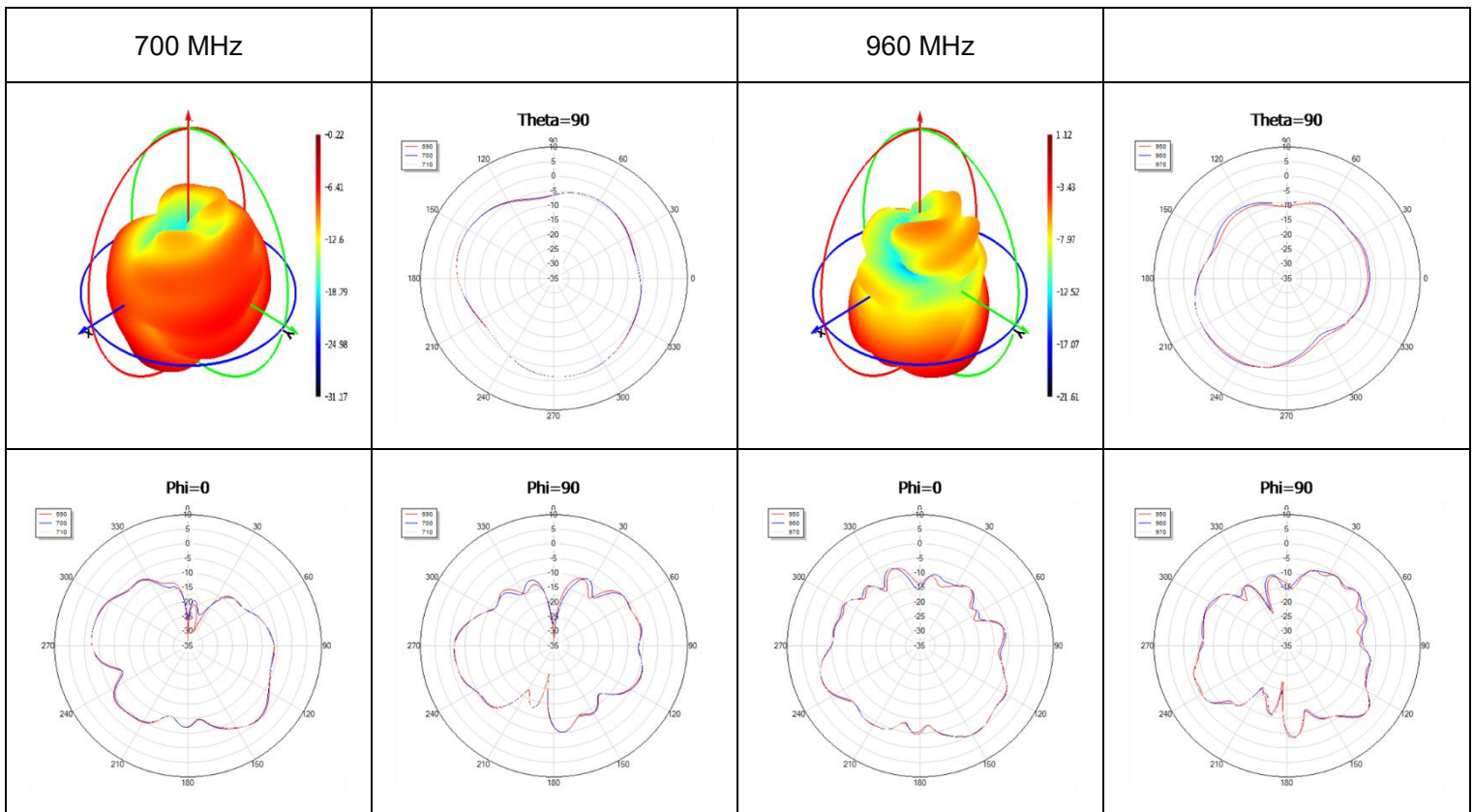

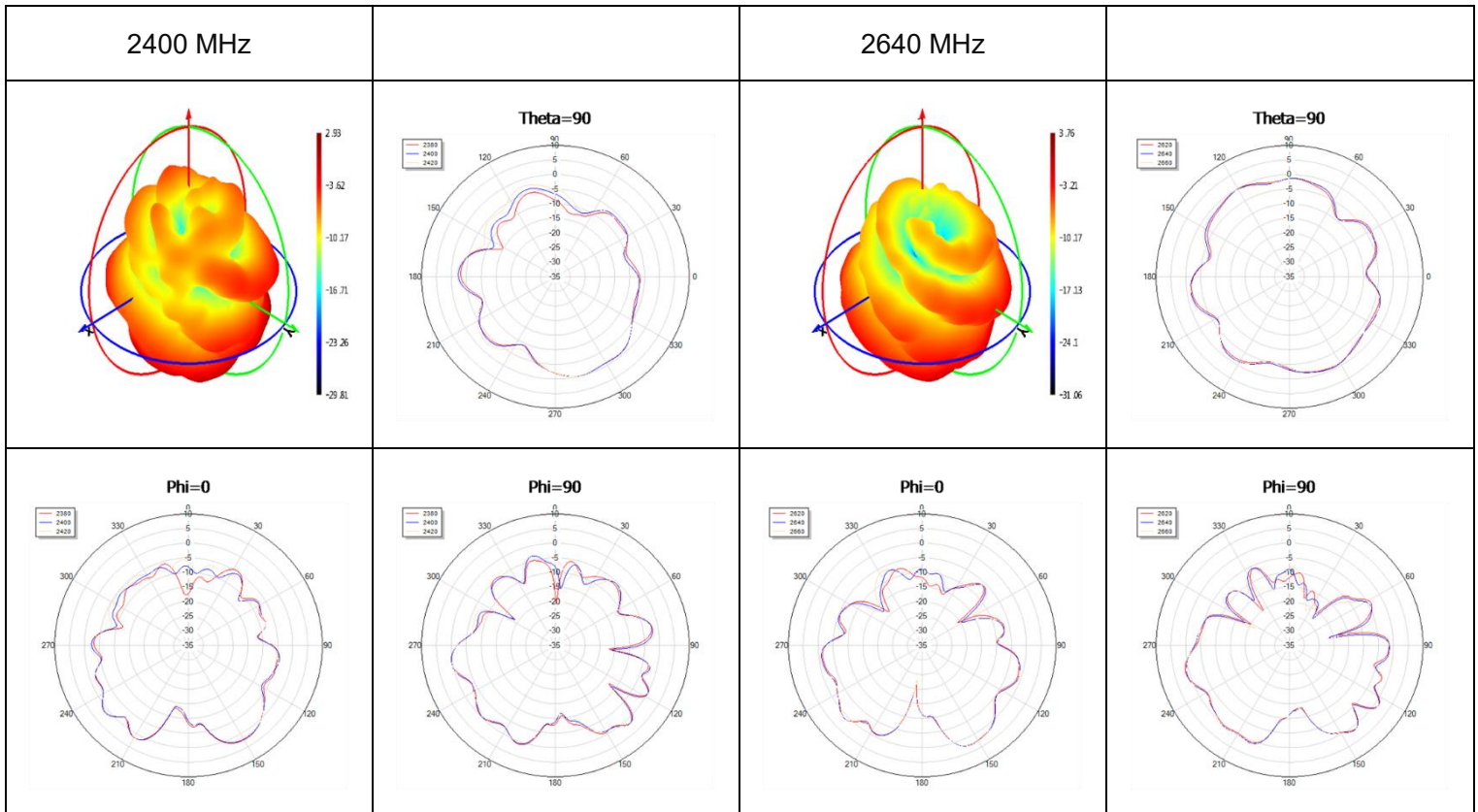
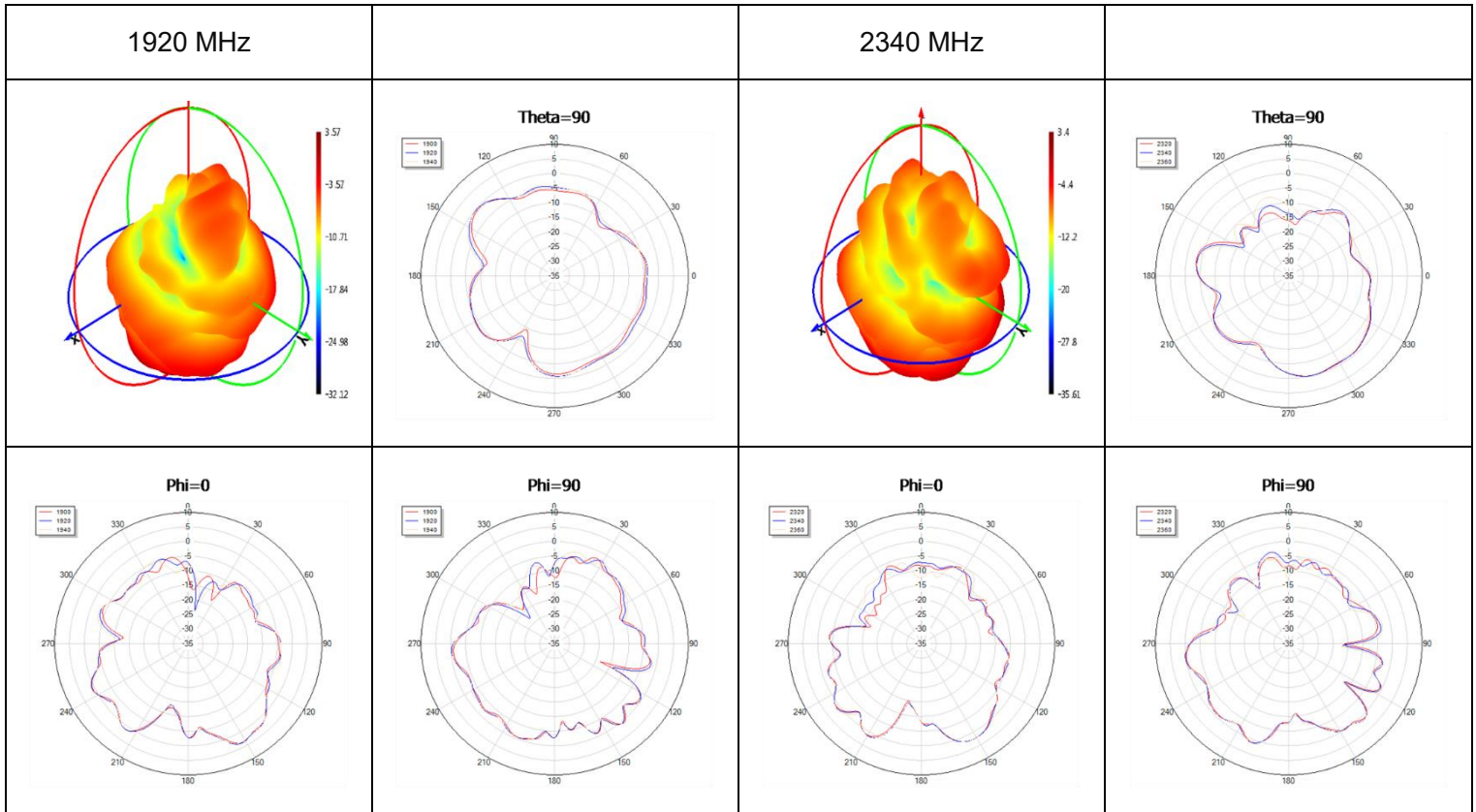

3.2.4.2. Test Condition: On 130 mm × 130 mm EVB

- Test Chamber: HF-S-1

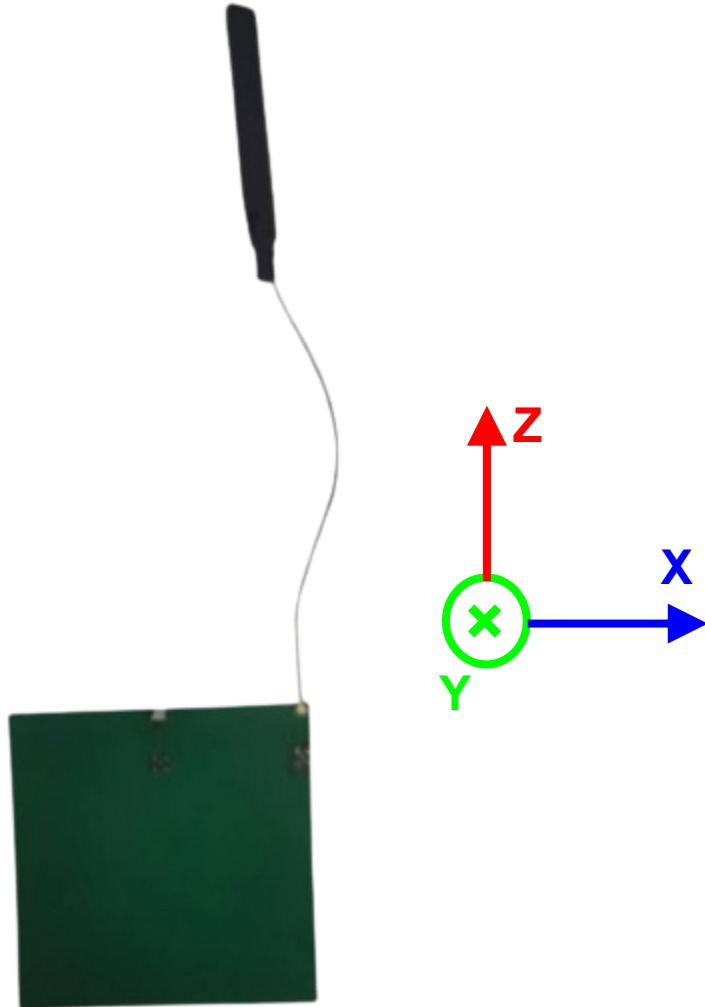

● 4G

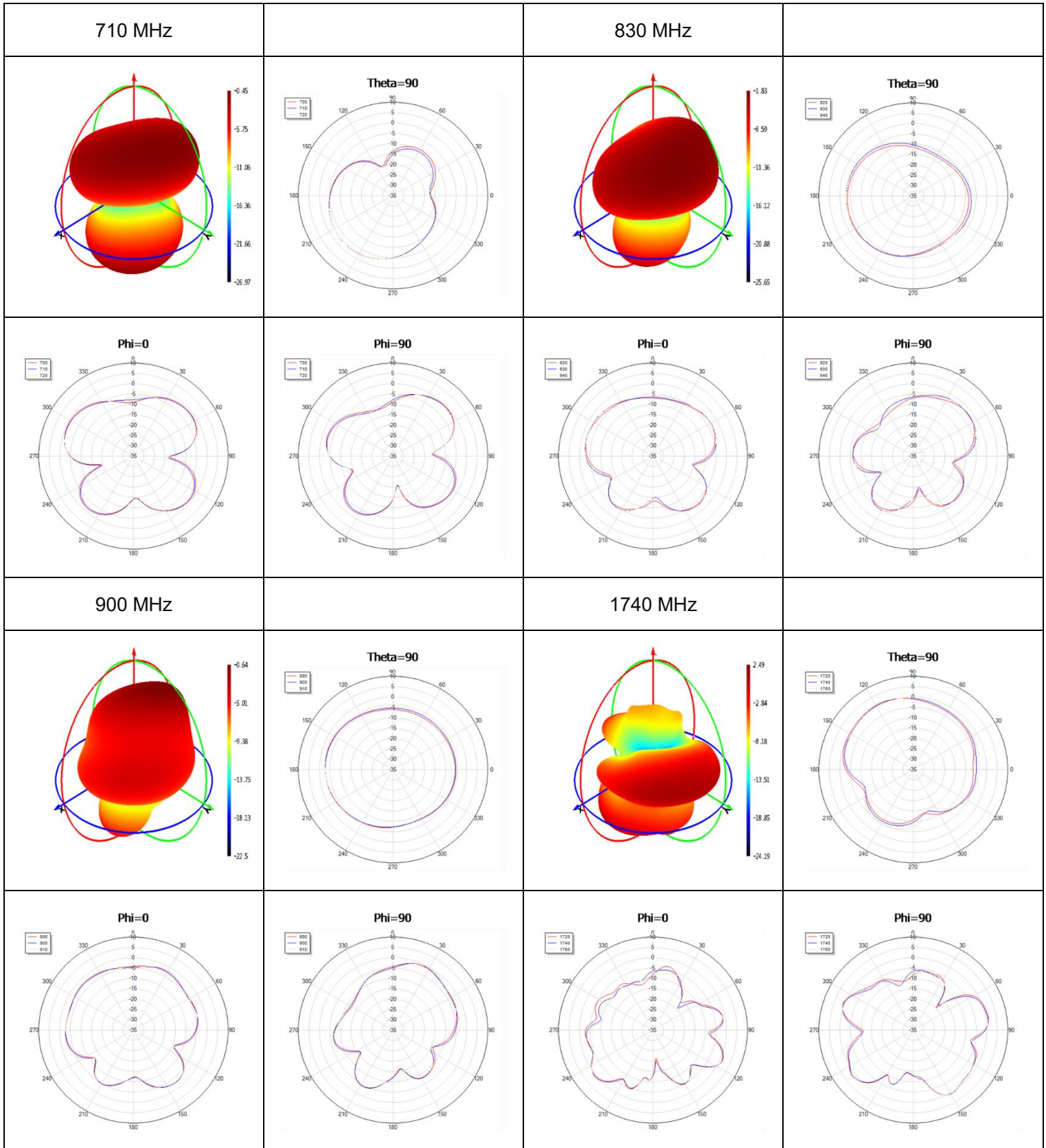

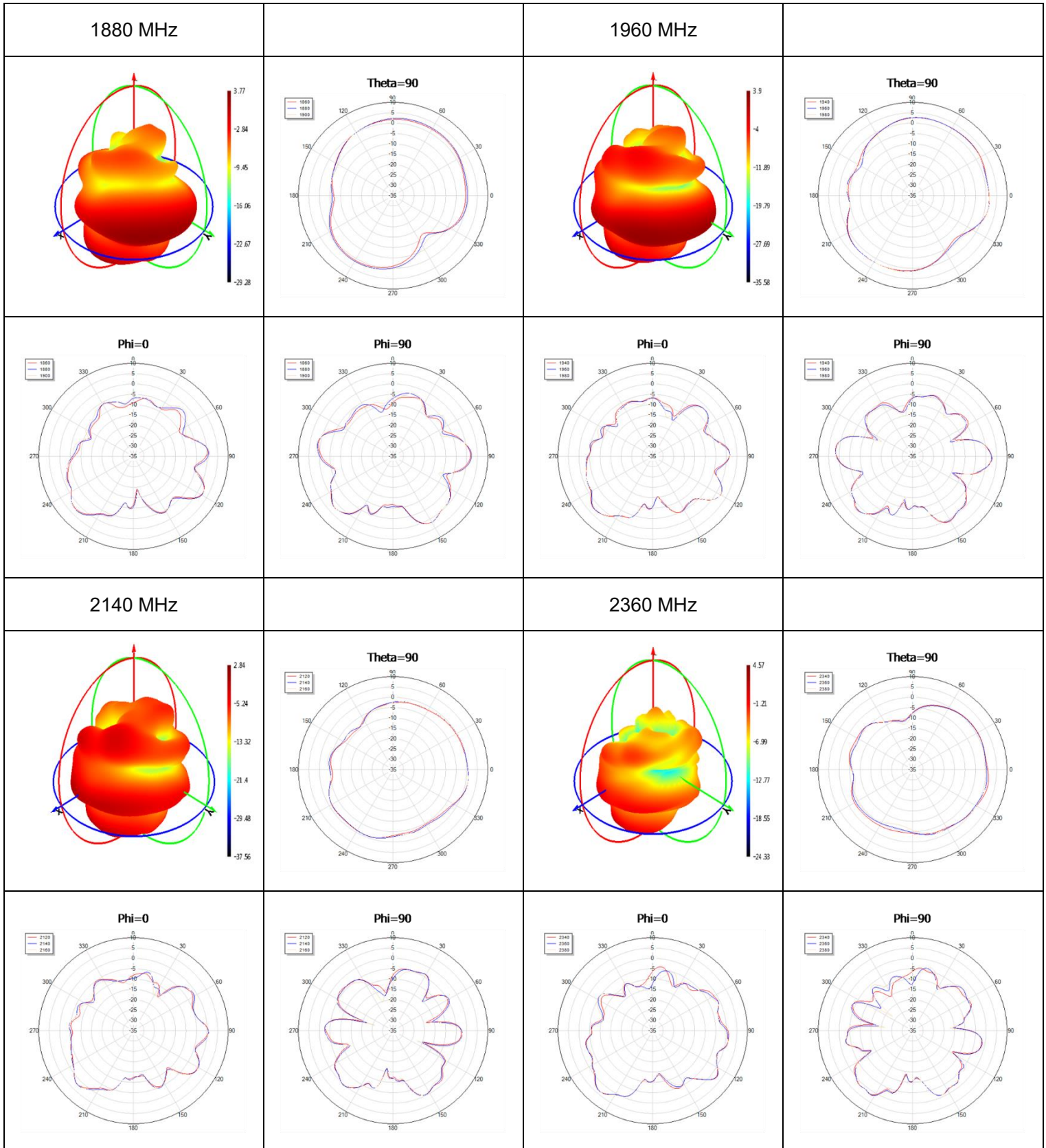

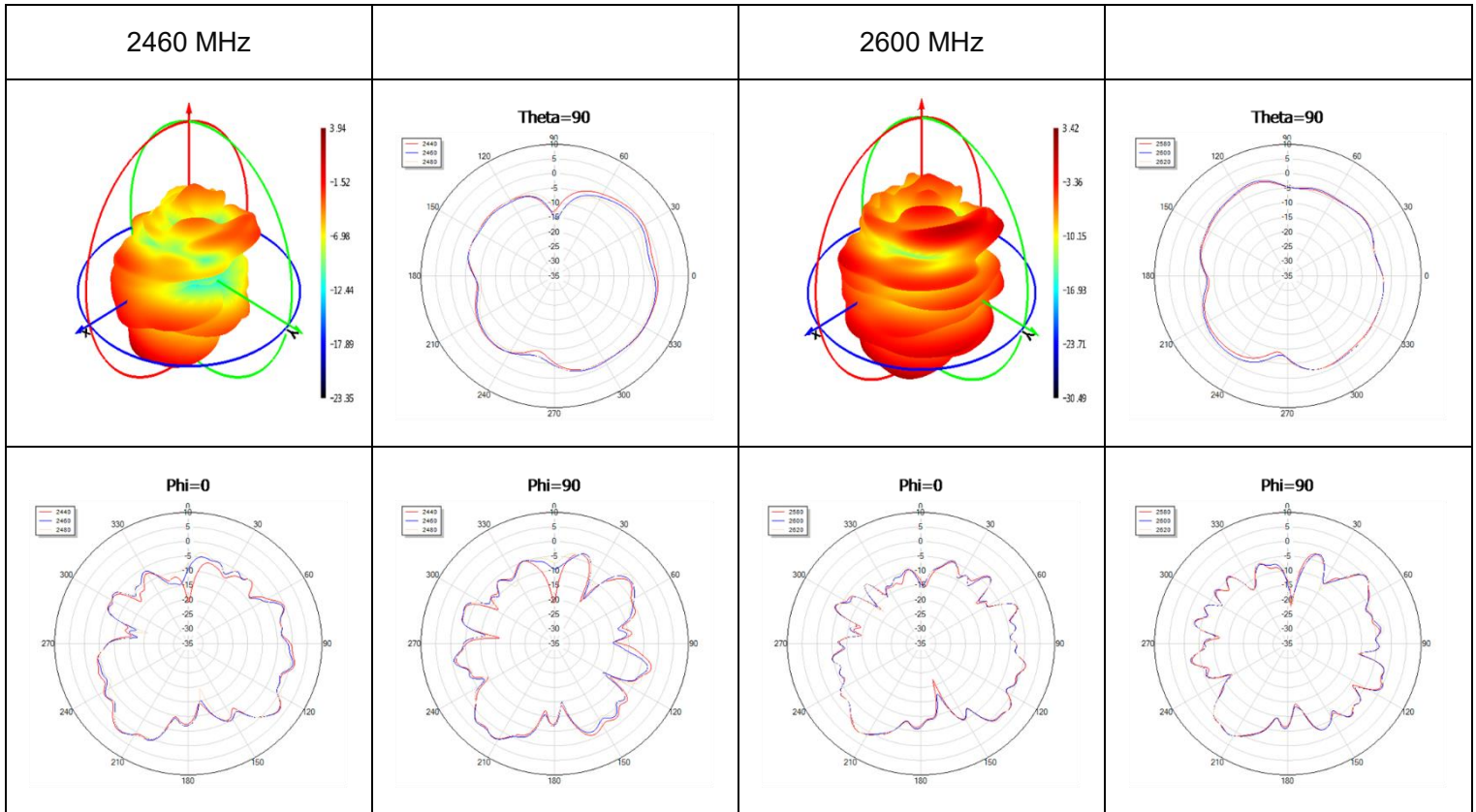

● **Max Peak Gain**

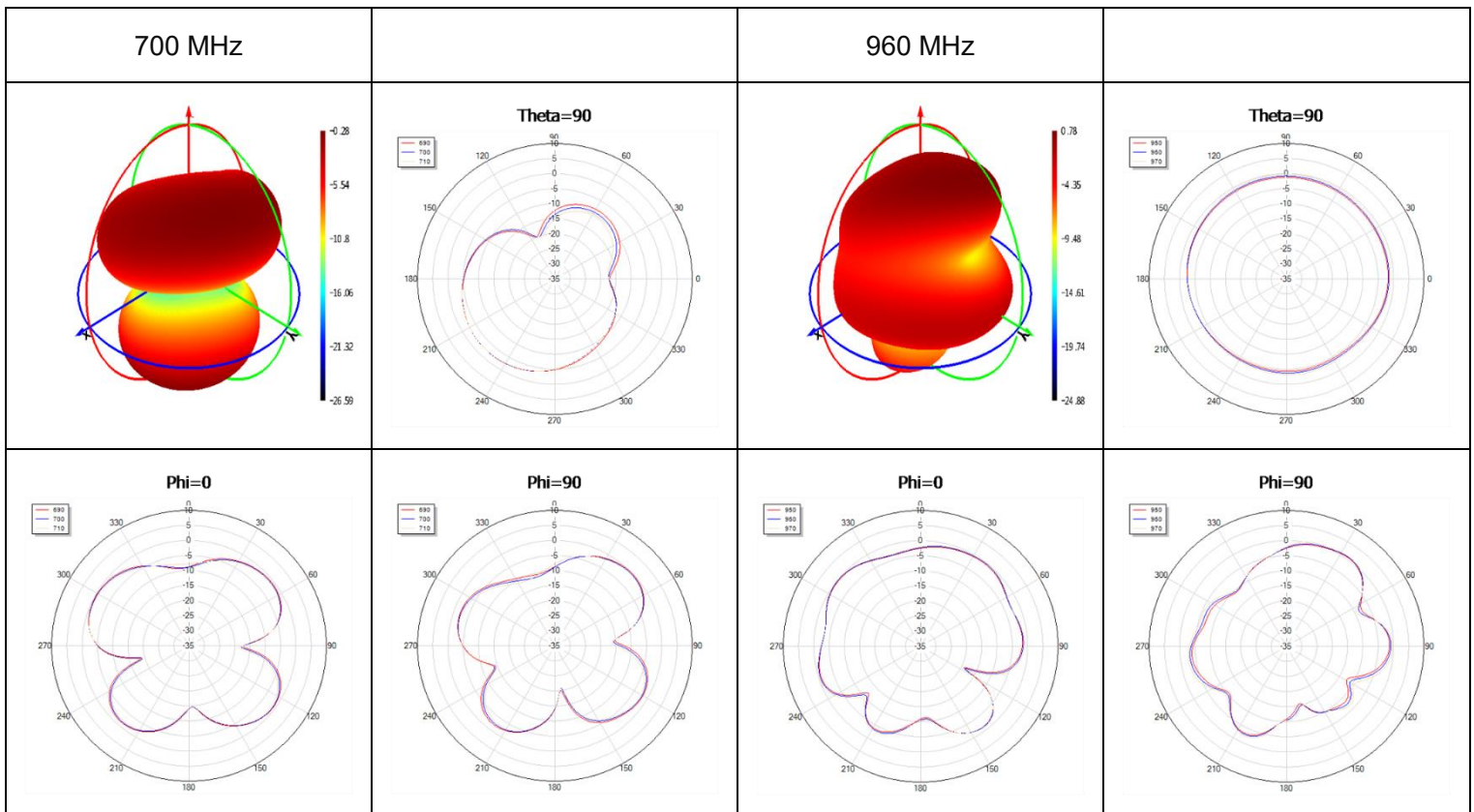

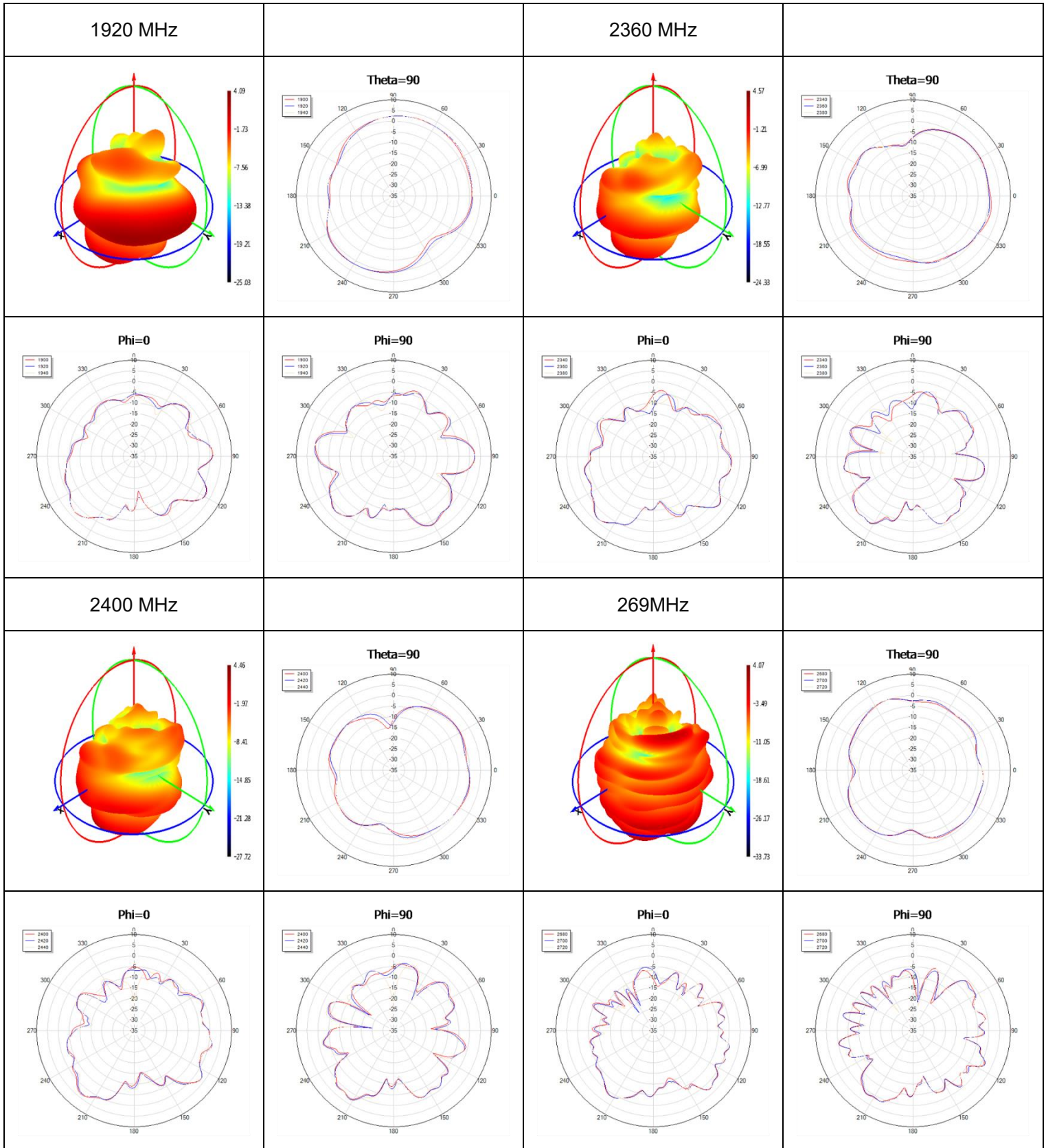

4 Packaging

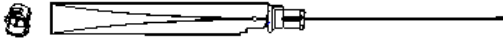
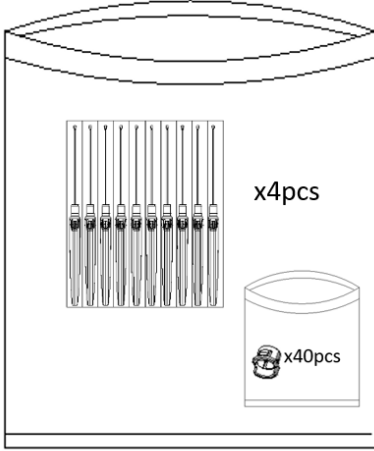
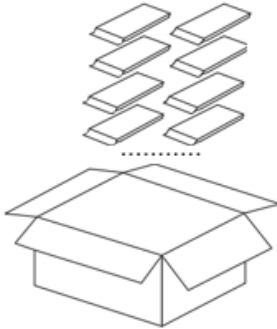
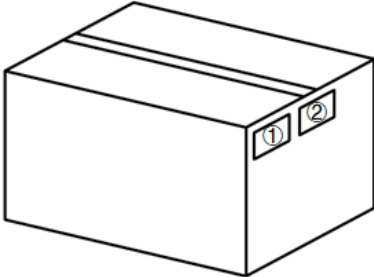
Step	Packaging Picture / 2D Picture	Description
1		Product drawing
2		40 antenna products in a PE bag. (40 Antennas / PE Bag)
3		(5 PE Bags / Carton Box) (200 Antennas / Carton Box) Estimated quantity Products that cannot fill the entire carton box are packed in a suitable size carton box. <u>Carton Size:</u> $L \times W \times H = 325 \times 325 \times 200 \text{ mm}$
4		Position for Attaching Labels ① Carton Label ② Quality Label

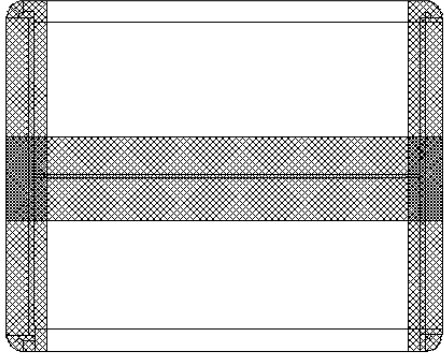
5	 A technical drawing of an H-shaped sealing carton. It consists of a central horizontal rectangular section with a cross-hatched texture, flanked by two vertical rectangular sections, also with a cross-hatched texture. The corners of the vertical sections are rounded. The entire structure is shown in a perspective view.	<p>Sealing Cartons H-shaped sealing cartons</p>
Note	<p>The initial packaging method described above is for reference only, and the final actual packaging method shall be subject to the actual shipping packaging.</p>	

Contact Us

At Quectel, our aim is to provide timely and comprehensive services to our customers. If you require any assistance, please contact our headquarters:

Quectel Wireless Solutions Co., Ltd.

Building 5, Shanghai Business Park Phase III (Area B), No.1016 Tianlin Road, Minhang District, Shanghai 200233, China

Tel: +86 21 5108 6236

Email: info@quectel.com

Or our local offices. For more information, please visit:

<http://www.quectel.com/support/sales.htm>.

For technical support, or to report documentation errors, please visit:

<http://www.quectel.com/support/technical.htm>.

Or email us at: support@quectel.com.

Legal Notices

We offer information as a service to you. The provided information is based on your requirements and we make every effort to ensure its quality. You agree that you are responsible for using independent analysis and evaluation in designing intended products, and we provide reference designs for illustrative purposes only. Before using any hardware, software or service guided by this document, please read this notice carefully. Even though we employ commercially reasonable efforts to provide the best possible experience, you hereby acknowledge and agree that this document and related services hereunder are provided to you on an “as available” basis. We may revise or restate this document from time to time at our sole discretion without any prior notice to you.

Use and Disclosure Restrictions

License Agreements

Documents and information provided by us shall be kept confidential, unless specific permission is granted. They shall not be accessed or used for any purpose except as expressly provided herein.

Copyright

Our and third-party products hereunder may contain copyrighted material. Such copyrighted material shall not be copied, reproduced, distributed, merged, published, translated, or modified without prior written consent. We and the third party have exclusive rights over copyrighted material. No license shall be granted or conveyed under any patents, copyrights, trademarks, or service mark rights. To avoid ambiguities, purchasing in any form cannot be deemed as granting a license other than the normal non-exclusive, royalty-free license to use the material. We reserve the right to take legal action for noncompliance with abovementioned requirements, unauthorized use, or other illegal or malicious use of the material.

Trademarks

Except as otherwise set forth herein, nothing in this document shall be construed as conferring any rights to use any trademark, trade name or name, abbreviation, or counterfeit product thereof owned by Quectel or any third party in advertising, publicity, or other aspects.

Third-Party Rights

This document may refer to hardware, software and/or documentation owned by one or more third parties (“third-party materials”). Use of such third-party materials shall be governed by all restrictions and obligations applicable thereto.

We make no warranty or representation, either express or implied, regarding the third-party materials, including but not limited to any implied or statutory, warranties of merchantability or fitness for a particular purpose, quiet enjoyment, system integration, information accuracy, and non-infringement of any third-party intellectual property rights with regard to the licensed technology or use thereof. Nothing herein constitutes a representation or warranty by us to either develop, enhance, modify, distribute, market, sell, offer for sale, or otherwise maintain production of any our products or any other hardware, software, device, tool, information, or product. We moreover disclaim any and all warranties arising from the course of dealing or usage of trade.

Privacy Policy

To implement module functionality, certain device data are uploaded to Quectel's or third-party's servers, including carriers, chipset suppliers or customer-designated servers. Quectel, strictly abiding by the relevant laws and regulations, shall retain, use, disclose or otherwise process relevant data for the purpose of performing the service only or as permitted by applicable laws. Before data interaction with third parties, please be informed of their privacy and data security policy.

Disclaimer

- a) We acknowledge no liability for any injury or damage arising from the reliance upon the information.
- b) We shall bear no liability resulting from any inaccuracies or omissions, or from the use of the information contained herein.
- c) While we have made every effort to ensure that the functions and features under development are free from errors, it is possible that they could contain errors, inaccuracies, and omissions. Unless otherwise provided by valid agreement, we make no warranties of any kind, either implied or express, and exclude all liability for any loss or damage suffered in connection with the use of features and functions under development, to the maximum extent permitted by law, regardless of whether such loss or damage may have been foreseeable.
- d) We are not responsible for the accessibility, safety, accuracy, availability, legality, or completeness of information, advertising, commercial offers, products, services, and materials on third-party websites and third-party resources.

Copyright © Quectel Wireless Solutions Co., Ltd. 2025. All rights reserved.

Revision History

Version	Date	Author	Note
-	2025-07-21	Nero ZHANG/ Lance SUN/ Riva REN/ Rainey LIAO	Creation of the document
1.0	2025-07-21	Nero ZHANG/ Lance SUN/ Riva REN/ Rainey LIAO	First official release

QUECTEL

www.quectel.com