



Antenna Datasheet

Product OC: YECT007AA

Version: 3.3

Date: 2025-03-11

Status: Released

Product Name: 4G Pole Mount Fiberglass Dipole External Antenna

Key Features:

Frequency Band: 698–2690 MHz

Dimensions: Φ 20 mm \times 300 mm

Efficiency: Up to 93 %

RoHS and REACH Compliant

IP65

Overview

This Quectel external 4G antenna covers main 4G LTE bands and is compatible with 3G/2G/LPWA bands as well. The external antenna is barely influenced by the internal environment of devices, giving a much better performance in efficiency, radiation and gain whilst providing an optimized solution for a customer product. Quectel also offers flexible installation with custom cable length and connector options.

Contents

Overview.....	1
Contents.....	2
1 Specification.....	3
1.1. Electrical.....	3
1.2. Mechanical & Environmental	4
2 Drawing	5
3 Detailed Performance.....	6
3.1. S-Parameter Test	6
3.1.1. VSWR	6
3.1.2. Return Loss.....	7
3.2. Radiation Performance Test.....	8
3.2.1. Efficiency.....	8
3.2.2. Average Gain	9
3.2.3. Peak Gain	10
3.2.4. 3D & 2D Radiation Pattern	11
3.2.4.1. Test Condition: Free Space	11
4 Packaging	16
Contact Us.....	18
Legal Notices	19
Revision History	21

1 Specification

Test Condition: Free Space

1.1. Electrical

Electrical	
Frequency Range	698–2690 MHz
Impedance	50 Ω
Polarization	Linear
Radiation Pattern	Omni-directional

Electrical – Detail													
SPEC	Band	Band	B71	B12 /B13 /B28	B5 /B8 /B26	n74 /n75 /n76	B1 /B2 /B3	B40	Wi-Fi 2G	B38 /B41	B42 /B48 /n77	n79	Wi-Fi 5G
	Band	Freq. (MHz)	600– 700	700– 810	820– 960	1420– 1520	1700– 2170	2300– 2400	2400– 2500	2500– 2690	3300– 4200	4400– 5000	5150– 5850
Max. VSWR	FS	-	2.0	2.9	-	1.8	1.2	1.2	1.7	-	-	-	
Max. Return Loss (dB)	FS	-	-9.7	-6.1	-	-11.1	-19.6	-19.2	-11.6	-	-	-	
AVG Eff. (%)	FS	-	51.6	46.5	-	80.7	84.5	86.9	73.7	-	-	-	
AVG.AVG Gain (dB)	FS	-	-2.9	-3.3	-	-1.0	-0.7	-0.6	-1.3	-	-	-	
Max. Peak Gain (dBi)	FS	-	0.1	1.3	-	0.9	1.4	1.9	1.9	-	-	-	
VSWR	FS		≤ 2.9										
Return Loss	FS		≤ -6.1 dB										

Peak Gain	FS	≤ 1.9 dBi
-----------	----	-----------

1.2. Mechanical & Environmental

Mechanical	
Antenna Dimensions	Φ 20 mm × 300 mm
Material & Color	Glass Fiber Reinforced Plastics & Gray
Connector Type	N Male
Mounting Type	Pole Mount
Weight	Typ. 146.2 g
Environmental	
Operation Temperature	-40 °C to +85 °C
Storage Temperature	-40 °C to +85 °C
Ingress Protection (IP) Rating	IP65
RoHS and REACH Compliant	Yes

3 Detailed Performance

3.1. S-Parameter Test

3.1.1. VSWR

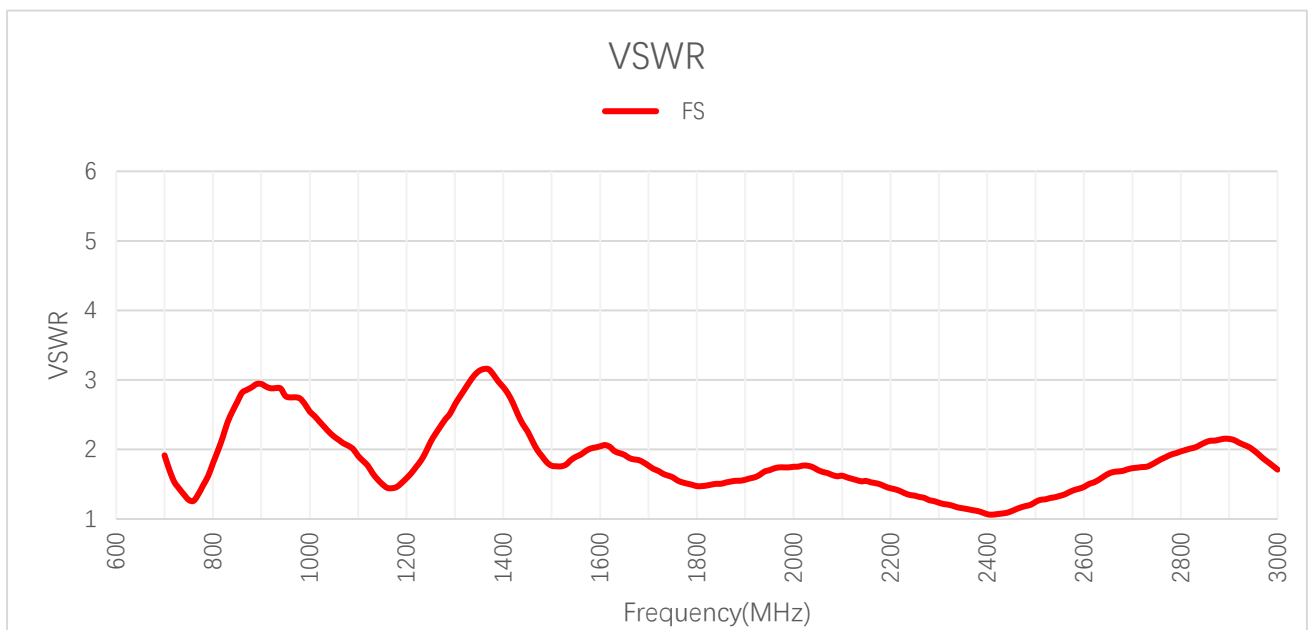

VSWR

Frequency (MHz)	600	630	710	830	900	960	1440	1710	1740	1880
VSWR	-	-	1.7	2.4	2.9	2.7	-	1.7	1.6	1.5
Frequency (MHz)	1950	2140	2350	2450	2600	2690	4700	5000	5500	6000
VSWR	1.7	1.5	1.2	1.1	1.5	1.7	-	-	-	-

3.1.2. Return Loss

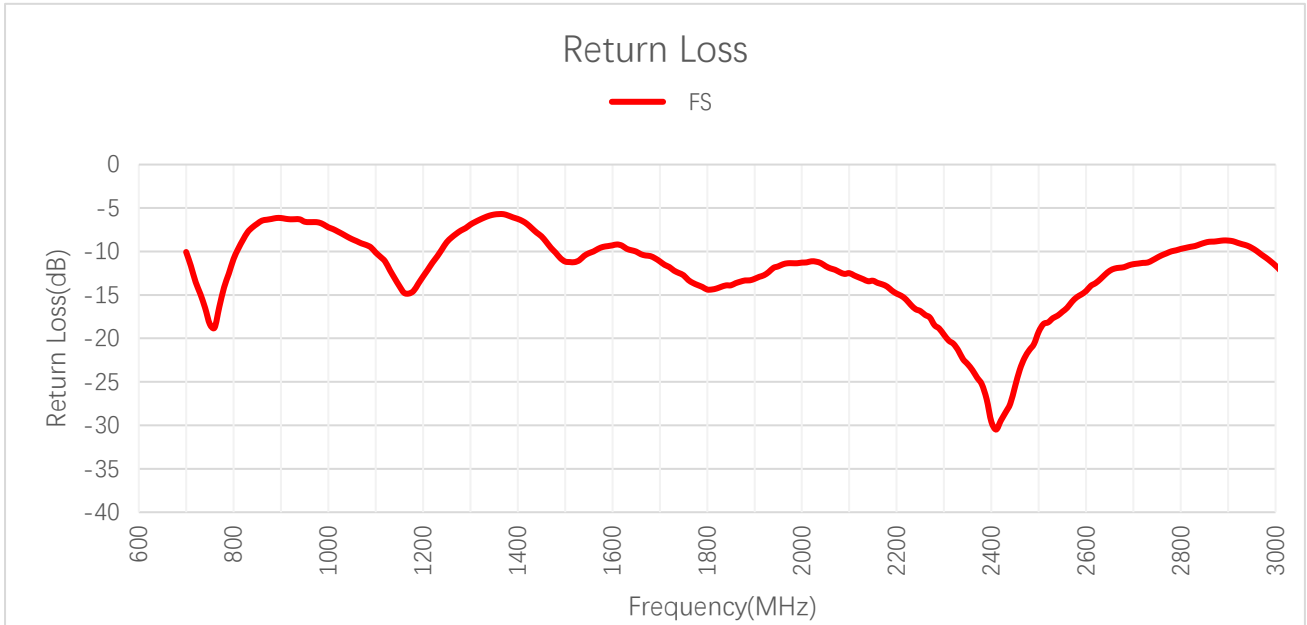

Return Loss (dB)

Frequency (MHz)	600	630	710	830	900	960	1440	1710	1740	1880
Return Loss (dB)	-	-	-11.7	-7.8	-6.1	-6.6	-	-11.5	-12.5	-13.3
Frequency (MHz)	1950	2140	2350	2450	2600	2690	4700	5000	5500	6000
Return Loss (dB)	-11.7	-13.4	-23.0	-25.5	-14.6	-11.6	-	-	-	-

3.2. Radiation Performance Test

3.2.1. Efficiency

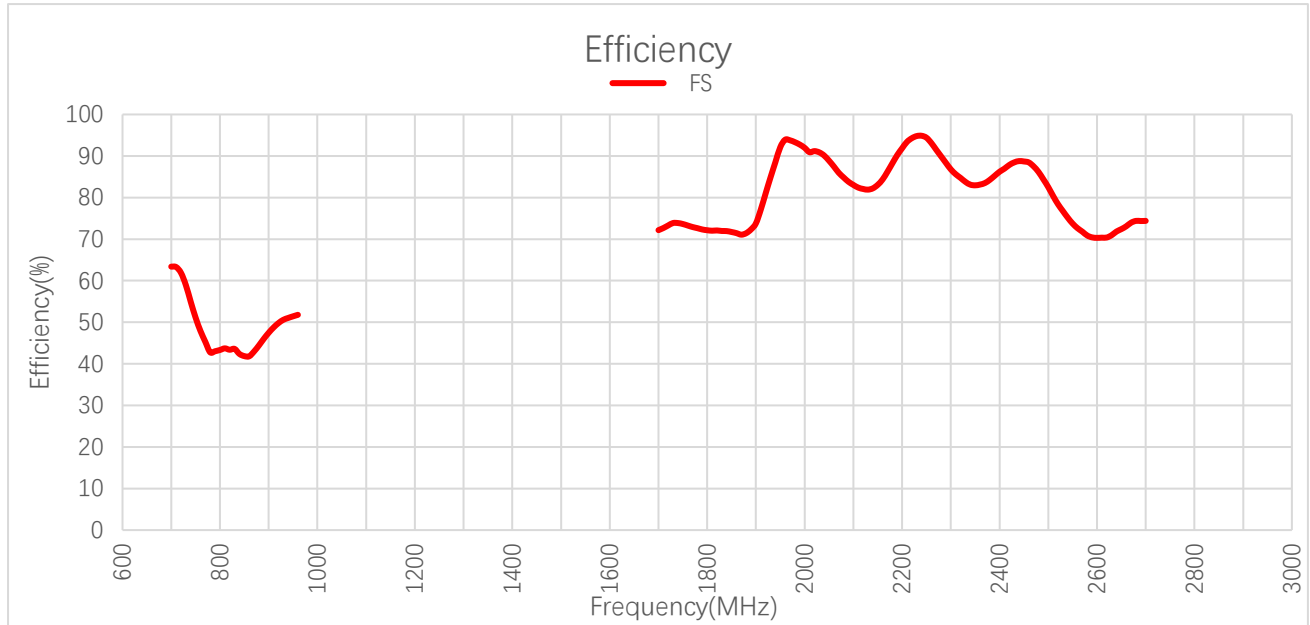

Efficiency (%)

Frequency (MHz)	600	630	710	830	900	960	1440	1710	1740	1880
Efficiency (%)	-	-	63.3	43.6	47.5	51.8	-	72.7	73.9	71.4
Frequency (MHz)	1950	2140	2350	2450	2600	2690	4700	5000	5500	6000
Efficiency (%)	92.1	82.2	83.0	88.7	70.3	74.4	-	-	-	-

3.2.2. Average Gain

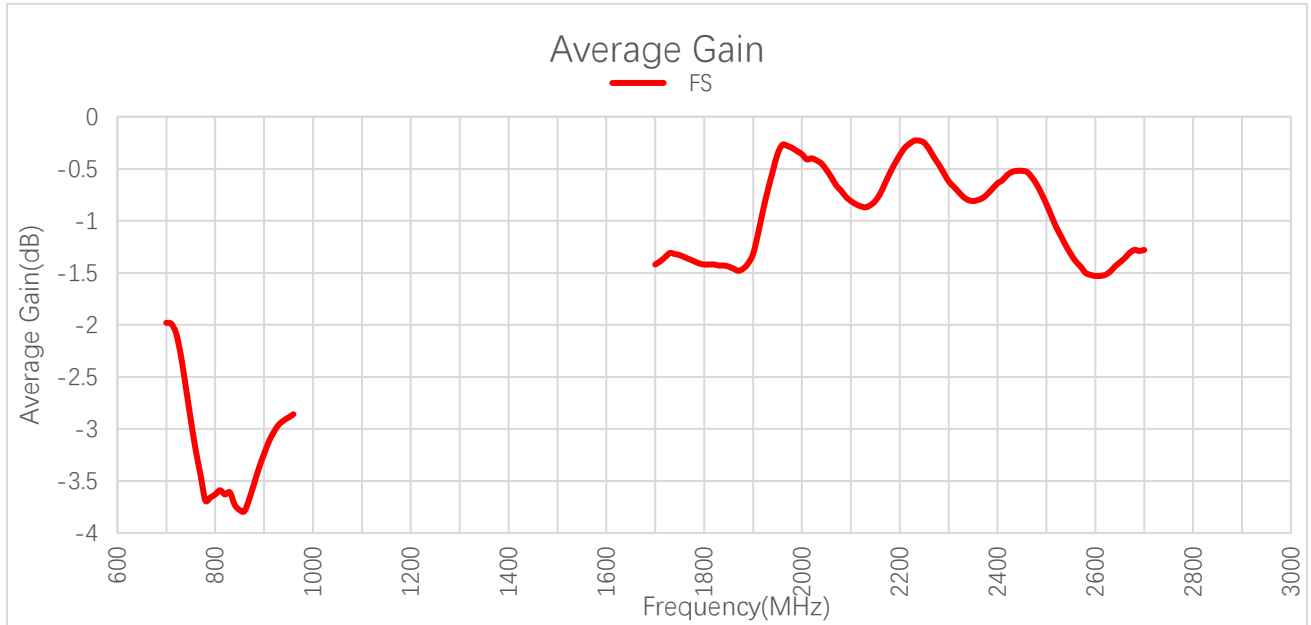

Average Gain (dB)

Frequency (MHz)	600	630	710	830	900	960	1440	1710	1740	1880
Average Gain (dB)	-	-	-2.0	-3.6	-3.2	-2.9	-	-1.4	-1.3	-1.5
Frequency (MHz)	1950	2140	2350	2450	2600	2690	4700	5000	5500	6000
Average Gain (dB)	-0.4	-0.9	-0.8	-0.5	-1.5	-1.3	-	-	-	-

3.2.3. Peak Gain

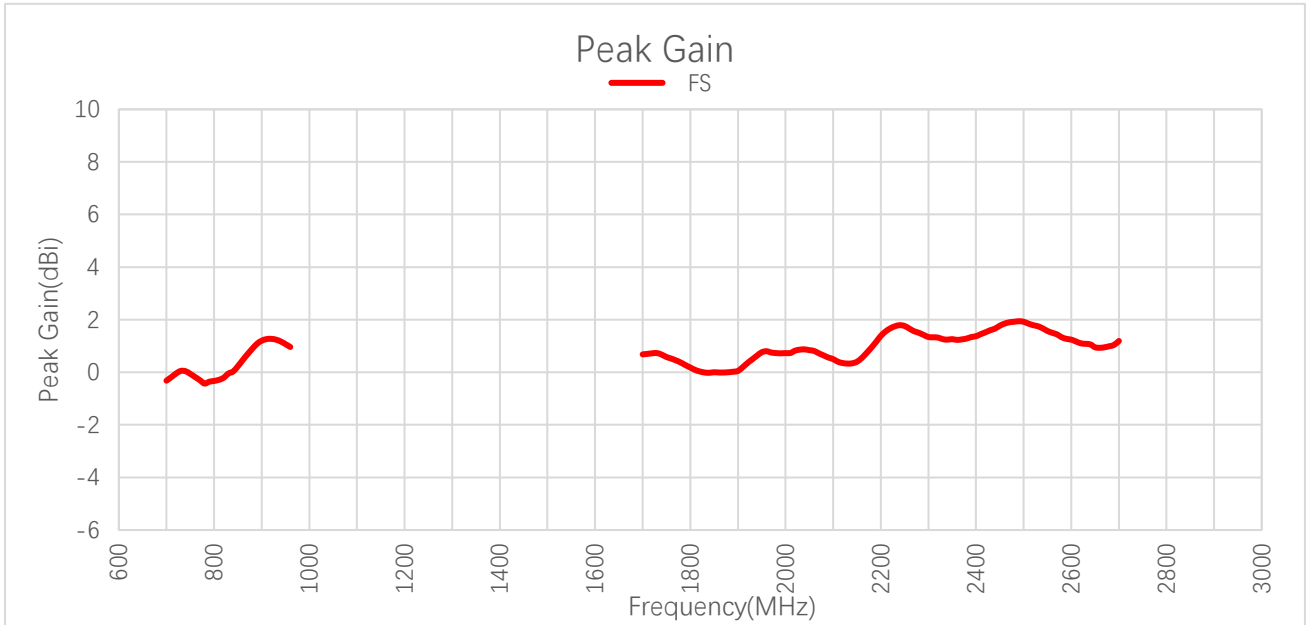

Peak Gain (dBi)

Frequency (MHz)	600	630	710	830	900	960	1440	1710	1740	1880
Peak Gain (dBi)	-	-	-0.2	-0.1	1.2	1.0	-	0.7	0.7	0.0
Frequency (MHz)	1950	2140	2350	2450	2600	2690	4700	5000	5500	6000
Peak Gain (dBi)	0.8	0.3	1.3	1.8	1.2	1.0	-	-	-	-

3.2.4. 3D & 2D Radiation Pattern

3.2.4.1. Test Condition: Free Space

- Test Chamber: GL-S-1

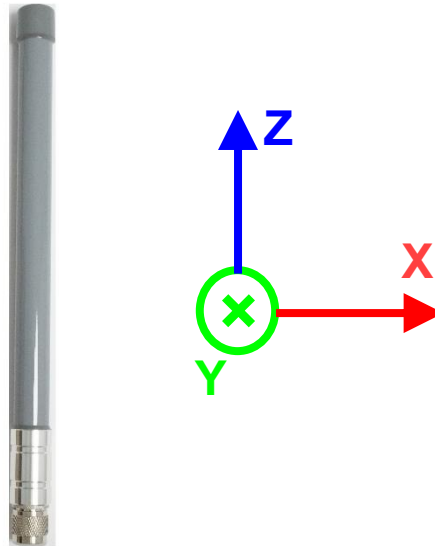

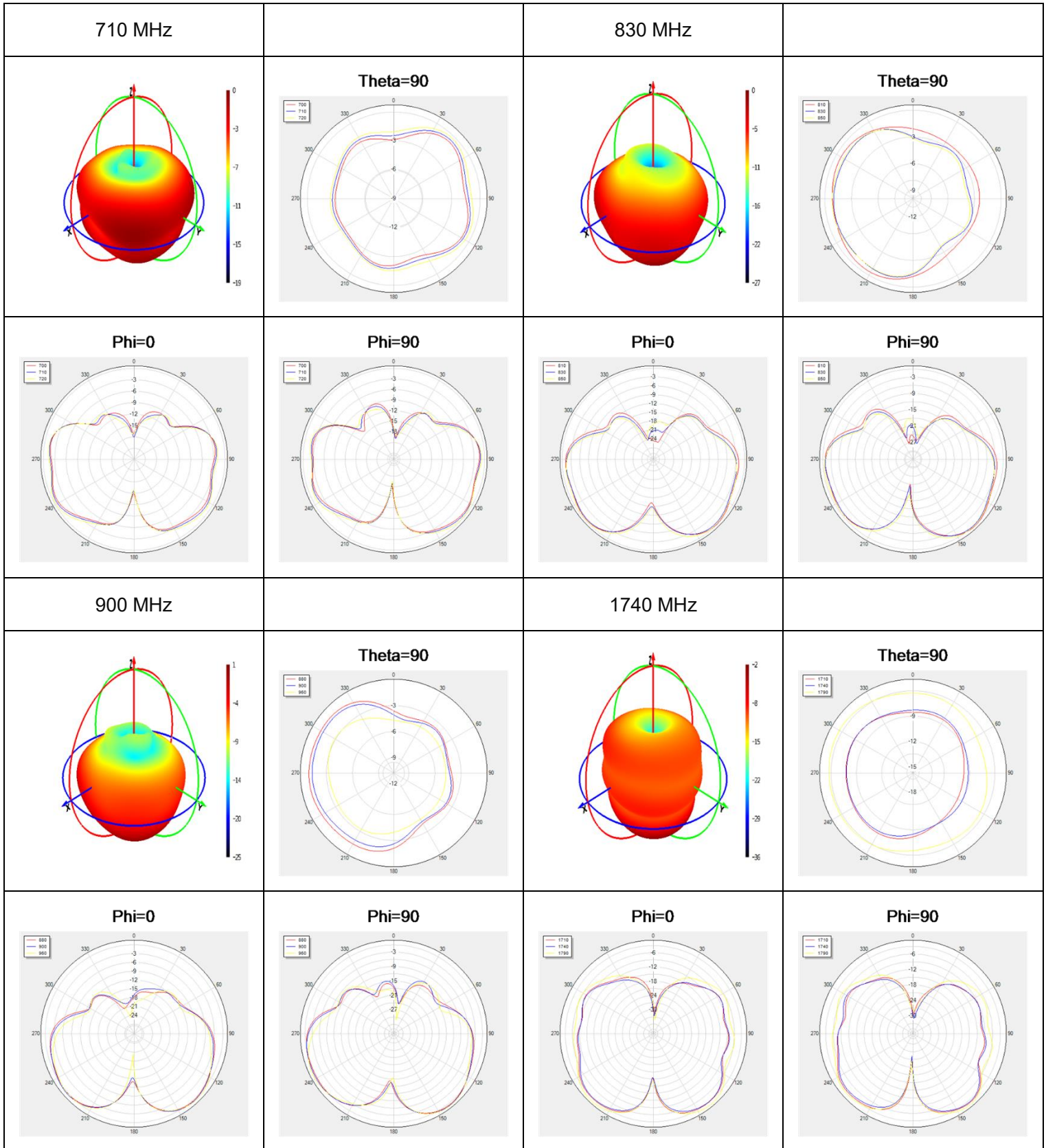

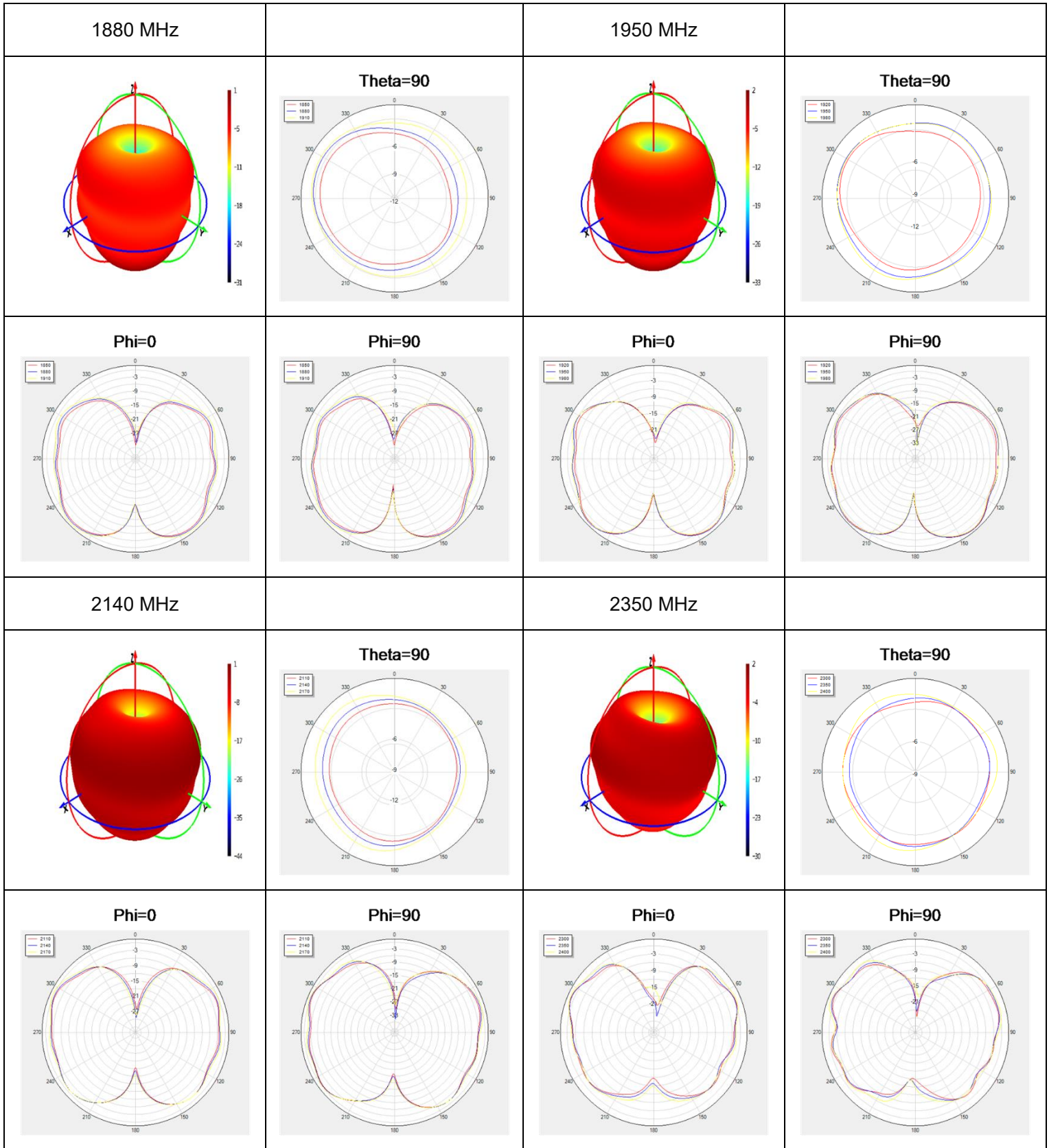

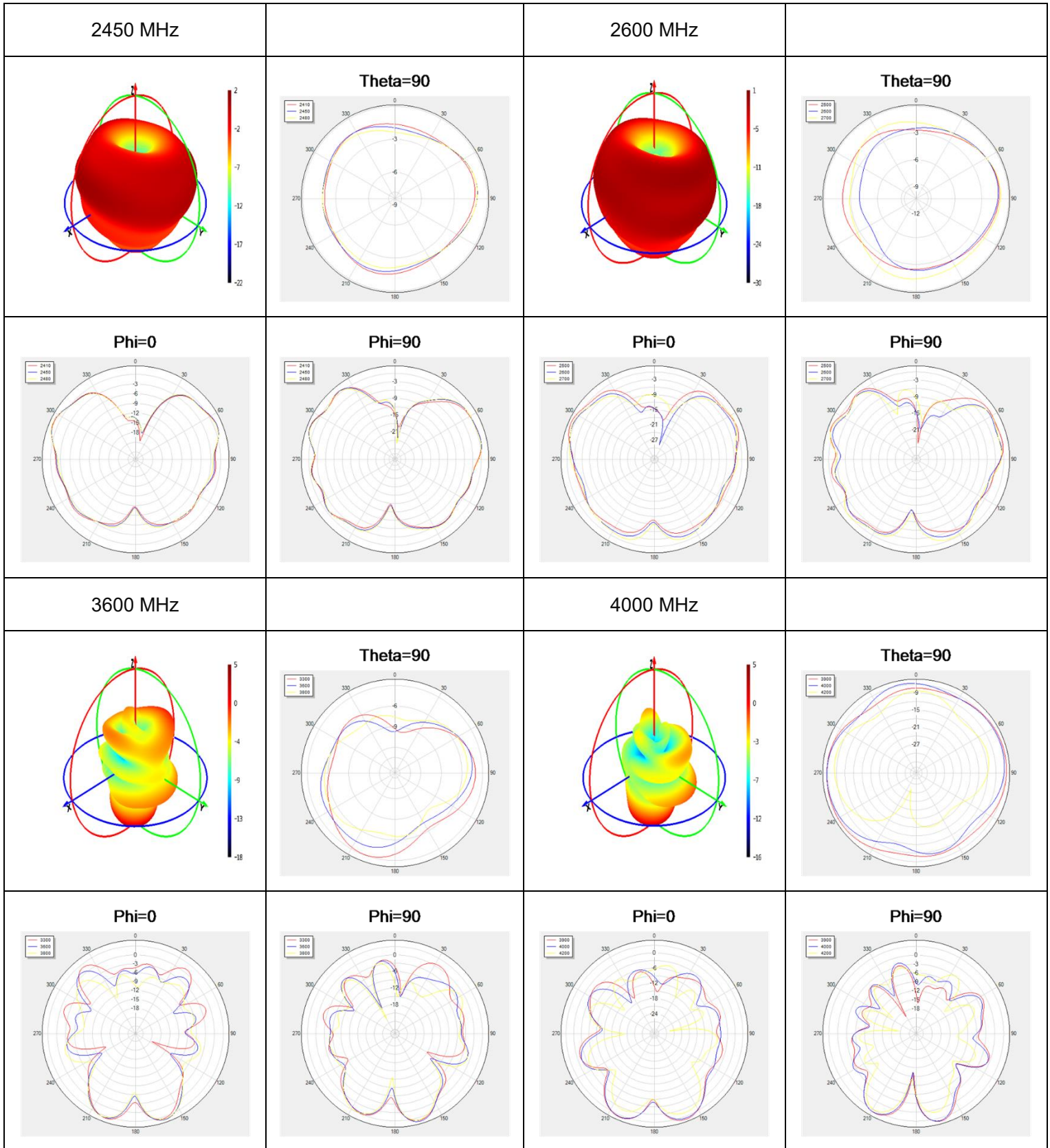

4700 MHz

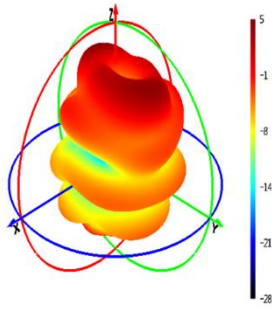

Theta=90

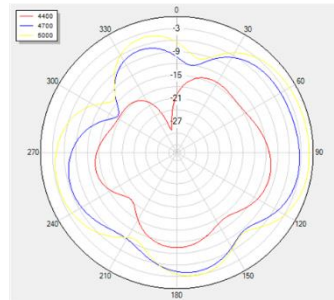

Phi=0

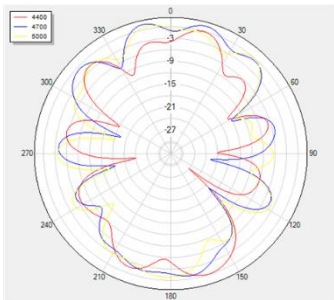

Phi=90

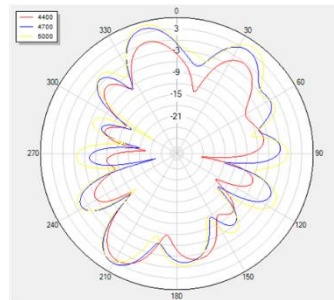

4 Packaging

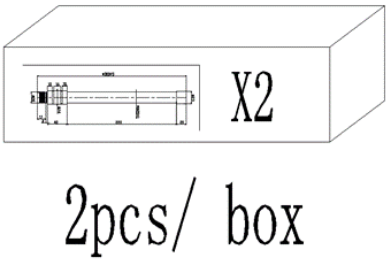
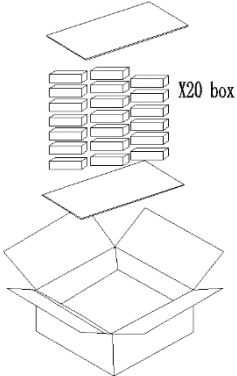
Step	Packaging Picture / 2D Picture	Description
1		<p>1 pc antenna product in a bubble bag. (1 PC / Bubble Bag)</p>
2		<p>(2 PCS Antennas / Inner Box)</p>
3		<p>(20 Inner Boxes / Carton Box) (40 PCS Antennas / Carton Box)</p> <p><u>Carton Size:</u> <u>L × W × H = 360 × 200 × 360 mm</u></p>

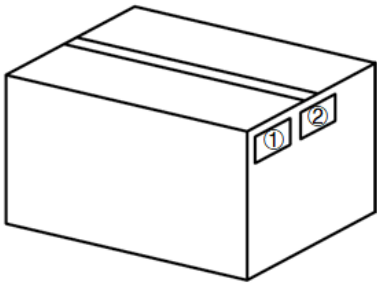
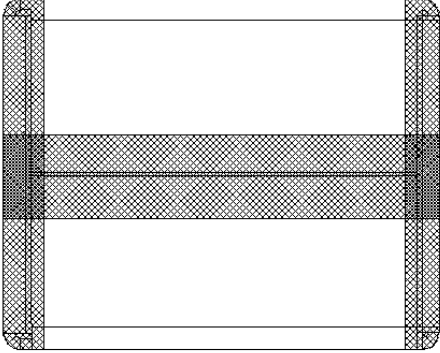
4	 A 3D perspective drawing of a rectangular cardboard box. On the front face, there are two small rectangular labels. The left label contains the number '1' and the right label contains the number '2'.	<p>Position for Attaching Labels</p> <ul style="list-style-type: none">① Carton Label② Quality Label
5	 A 3D perspective drawing of a rectangular cardboard box. The box is shown with a shaded, cross-hatched pattern representing an H-shaped sealing structure. This structure consists of a horizontal band across the middle and two vertical bands on the left and right sides, forming an 'H' shape.	<p>Sealing Cartons H-shaped sealing cartons</p>

Contact Us

At Quectel, our aim is to provide timely and comprehensive services to our customers. If you require any assistance, please contact our headquarters:

Quectel Wireless Solutions Co., Ltd.

Building 5, Shanghai Business Park Phase III (Area B), No.1016 Tianlin Road, Minhang District, Shanghai 200233, China

Tel: +86 21 5108 6236

Email: info@quectel.com

Or our local offices. For more information, please visit:

<http://www.quectel.com/support/sales.htm>.

For technical support, or to report documentation errors, please visit:

<http://www.quectel.com/support/technical.htm>.

Or email us at: support@quectel.com.

Legal Notices

We offer information as a service to you. The provided information is based on your requirements and we make every effort to ensure its quality. You agree that you are responsible for using independent analysis and evaluation in designing intended products, and we provide reference designs for illustrative purposes only. Before using any hardware, software or service guided by this document, please read this notice carefully. Even though we employ commercially reasonable efforts to provide the best possible experience, you hereby acknowledge and agree that this document and related services hereunder are provided to you on an “as available” basis. We may revise or restate this document from time to time at our sole discretion without any prior notice to you.

Use and Disclosure Restrictions

License Agreements

Documents and information provided by us shall be kept confidential, unless specific permission is granted. They shall not be accessed or used for any purpose except as expressly provided herein.

Copyright

Our and third-party products hereunder may contain copyrighted material. Such copyrighted material shall not be copied, reproduced, distributed, merged, published, translated, or modified without prior written consent. We and the third party have exclusive rights over copyrighted material. No license shall be granted or conveyed under any patents, copyrights, trademarks, or service mark rights. To avoid ambiguities, purchasing in any form cannot be deemed as granting a license other than the normal non-exclusive, royalty-free license to use the material. We reserve the right to take legal action for noncompliance with abovementioned requirements, unauthorized use, or other illegal or malicious use of the material.

Trademarks

Except as otherwise set forth herein, nothing in this document shall be construed as conferring any rights to use any trademark, trade name or name, abbreviation, or counterfeit product thereof owned by Quectel or any third party in advertising, publicity, or other aspects.

Third-Party Rights

This document may refer to hardware, software and/or documentation owned by one or more third parties (“third-party materials”). Use of such third-party materials shall be governed by all restrictions and obligations applicable thereto.

We make no warranty or representation, either express or implied, regarding the third-party materials, including but not limited to any implied or statutory, warranties of merchantability or fitness for a particular purpose, quiet enjoyment, system integration, information accuracy, and non-infringement of any third-party intellectual property rights with regard to the licensed technology or use thereof. Nothing herein constitutes a representation or warranty by us to either develop, enhance, modify, distribute, market, sell, offer for sale, or otherwise maintain production of any our products or any other hardware, software, device, tool, information, or product. We moreover disclaim any and all warranties arising from the course of dealing or usage of trade.

Privacy Policy

To implement module functionality, certain device data are uploaded to Quectel's or third-party's servers, including carriers, chipset suppliers or customer-designated servers. Quectel, strictly abiding by the relevant laws and regulations, shall retain, use, disclose or otherwise process relevant data for the purpose of performing the service only or as permitted by applicable laws. Before data interaction with third parties, please be informed of their privacy and data security policy.

Disclaimer

- a) We acknowledge no liability for any injury or damage arising from the reliance upon the information.
- b) We shall bear no liability resulting from any inaccuracies or omissions, or from the use of the information contained herein.
- c) While we have made every effort to ensure that the functions and features under development are free from errors, it is possible that they could contain errors, inaccuracies, and omissions. Unless otherwise provided by valid agreement, we make no warranties of any kind, either implied or express, and exclude all liability for any loss or damage suffered in connection with the use of features and functions under development, to the maximum extent permitted by law, regardless of whether such loss or damage may have been foreseeable.
- d) We are not responsible for the accessibility, safety, accuracy, availability, legality, or completeness of information, advertising, commercial offers, products, services, and materials on third-party websites and third-party resources.

Copyright © Quectel Wireless Solutions Co., Ltd. 2025. All rights reserved.

Revision History

Version	Date	Author	Note
-	2021-09-22	Mordecai LIU/ Jason LONG	Creation of the document
1.0	2021-09-22	Mordecai LIU/ Jason LONG	First official release
2.0	2022-03-01	Mordecai LIU/ Jason LOG	Updated all test data in this datasheet.
2.1	2022-04-27	Mordecai LIU/ Jason LONG	Updated mounting type (Chapter 6).
2.2	2022-12-29	Jason LONG	Update the drawings in Chapter 6.
3.0	2023-05-17	Damon ZHANG/ Lucky FENG/ David LIU/ Aria CHU	Updated all data and datasheet template.
3.1	2023-12-05	Lucky FENG/ Aria CHU	Added storage temperature and REACH compliant (Chapter 1.1).
3.2	2024-07-04	Lucky FENG	Update the drawing (Chapter 2).
3.3	2025-03-11	Rainey LIAO	Updated the starting frequency to 698 MHz (Homepage and Chapter 1.1).

QUECTEL

www.quectel.com