



Antenna Datasheet

Product OC: YEBT001WFXM

Version: 1.0

Date: 2025-10-15

Status: Released

Product Name: Wi-Fi & V2X Terminal Mount Rubber Monopole Antenna

Key Features:

Frequency Band: Wi-Fi: 2400–2500 MHz, 5150–5850 MHz,
5925–7125 MHz;

V2X: 5850–5925 MHz

Dimensions: Φ 9 mm × 54.9 mm

Efficiency: Up to 74.8 %

RoHS & REACH Compliant

IP54

Overview

YEBT001WFXM is a Wi-Fi & V2X rubber antenna measuring Φ 9 mm \times 54.9 mm. This ultra-wide-band antenna provides broad coverage from 2400–2500 MHz, 5150–7125 MHz. The antenna is terminated with RP-SMA Male connectors. This low profile, terminal mount omni-directional antenna, ideal for applications where the antenna is required to be discrete, is easy to install with maximum durability assured thanks to its TPE enclosure. It is compatible with Quectel's Wi-Fi and V2X Series modules.

It allows constant and reliable transmission and reception due to its omni-directional gain across all frequency bands. YEBT001WFXM is designed as a monopole antenna, which needs to be mounted on a ground plane to offer high efficiency in all working bands. It is a perfect antenna product for customers that desire highest performance. This high-efficiency, high-gain omni-directional antenna is ideally suited for gateways and routers, IoT Sensors, public safety and security, point of sales terminals, smart home automation, robotics / autonomous, V2X mesh networks system.

Typical applications include:

- Gateways and Routers
- IoT Sensors
- Public Safety and Security
- Point of Sales Terminals
- Smart Home Automation
- Robotics / Autonomous
- V2X mesh networks system

Quectel provides comprehensive antenna design support such as simulation, testing and manufacturing for custom antenna solutions to meet your specific application needs. We have regional R & D centers to offer quick response to meet your requirements. Please contact our sales & FAEs if you have any requests.

Contents

Overview.....	1
Contents.....	2
1 Specification.....	3
1.1. Electrical.....	3
1.1.1. Wi-Fi.....	3
1.1.2. V2X.....	4
1.2. Mechanical & Environmental	5
2 Drawing	6
3 Detailed Performance	7
3.1. S-Parameter Test	7
3.1.1. VSWR.....	7
3.1.2. Return Loss	8
3.2. Radiation Performance Test.....	9
3.2.1. Efficiency	9
3.2.2. Average Gain	10
3.2.3. Peak Gain.....	11
3.2.4. 3D & 2D Radiation Pattern.....	12
4 Packaging	15
Contact Us.....	17
Legal Notices	18
Revision History	20

1 Specification

Test Condition: On 130 mm × 70 mm EVB

1.1. Electrical

Electrical		
Frequency Range	Wi-Fi	2400–2500 MHz, 5150–5850 MHz, 5925–7125 MHz
	V2X	5850–5925 MHz
Impedance	50 Ω	
Polarization	Linear	
Radiation Pattern	Omni-directional	

1.1.1. Wi-Fi

Specification	Band	Band	Wi-Fi 2G	Wi-Fi 5G	Wi-Fi 6G
		Freq. (MHz)	2400–2500	5150–5850	5925–7125
Max. VSWR			1.8	1.9	2.4
Max. Return Loss (dB)			-11.1	-10.1	-7.7
AVG Eff. (%)			37.4	60.7	62.5
AVG AVG Gain (dB)			-4.3	-2.2	-2.1
Max. Peak Gain (dBi)			2.5	3.2	4.3
VSWR	≤ 2.4				
Return Loss	≤ -7.7 dB				
Peak Gain	≤ 4.3 dBi				

1.1.2. V2X

Specification	Band	Band	V2X
		Freq. (MHz)	5850–5925
Max. VSWR			1.9
Max. Return Loss (dB)			-10.4
AVG Eff. (%)			58.4
AVG AVG Gain (dB)			-2.3
Max. Peak Gain (dBi)			2.9
VSWR		≤ 1.9	
Return Loss		≤ -10.4 dB	
Peak Gain		≤ 2.9 dBi	

1.2. Mechanical & Environmental

Mechanical	
Antenna Dimensions	Φ 9 mm × 54.9 mm
Casing Material & Color	TPE & White
Connector Type	RP-SMA Male
Mounting Type	Terminal
Weight	Typ. 5.1 g
Environmental	
Operation Temperature	-40 °C to +85 °C
Storage Temperature	-40 °C to +85 °C
Ingress Protection (IP) Rating	IP54
RoHS & REACH Compliant	Yes

2 Drawing

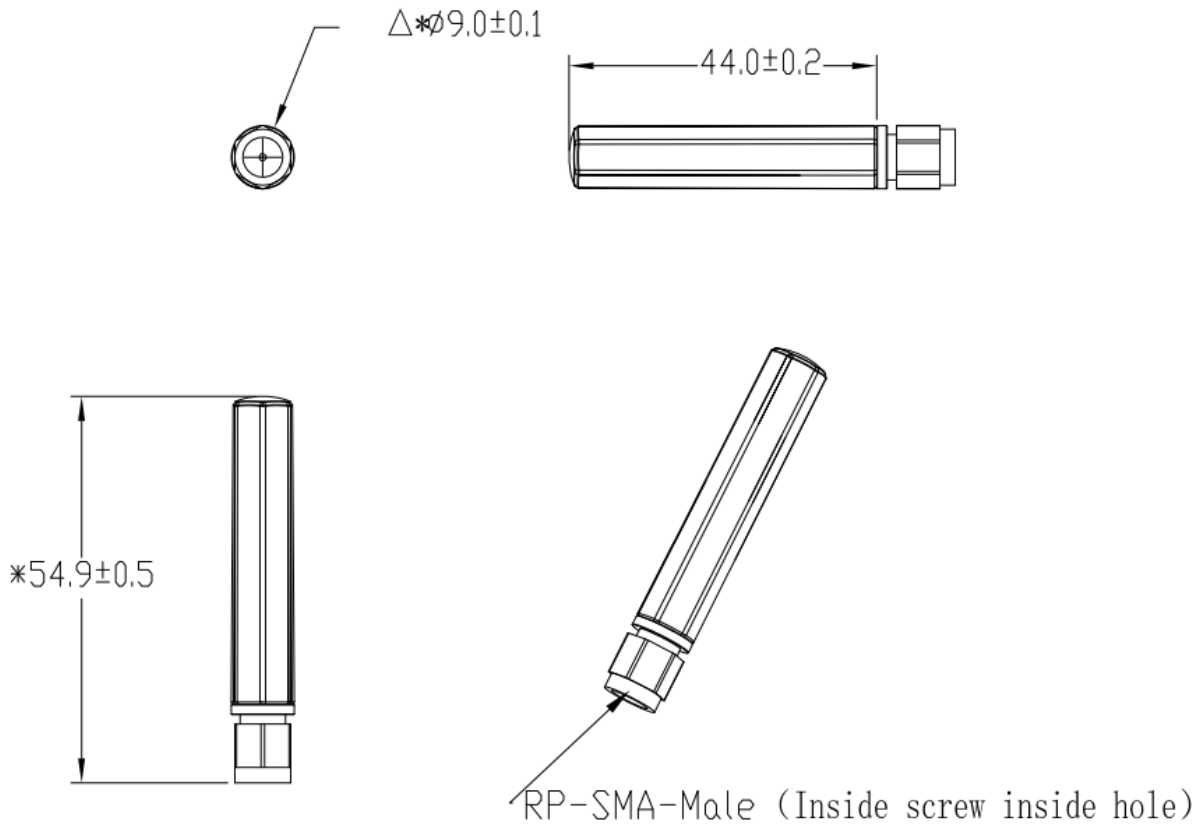

3 Detailed Performance

3.1. S-Parameter Test

3.1.1. VSWR

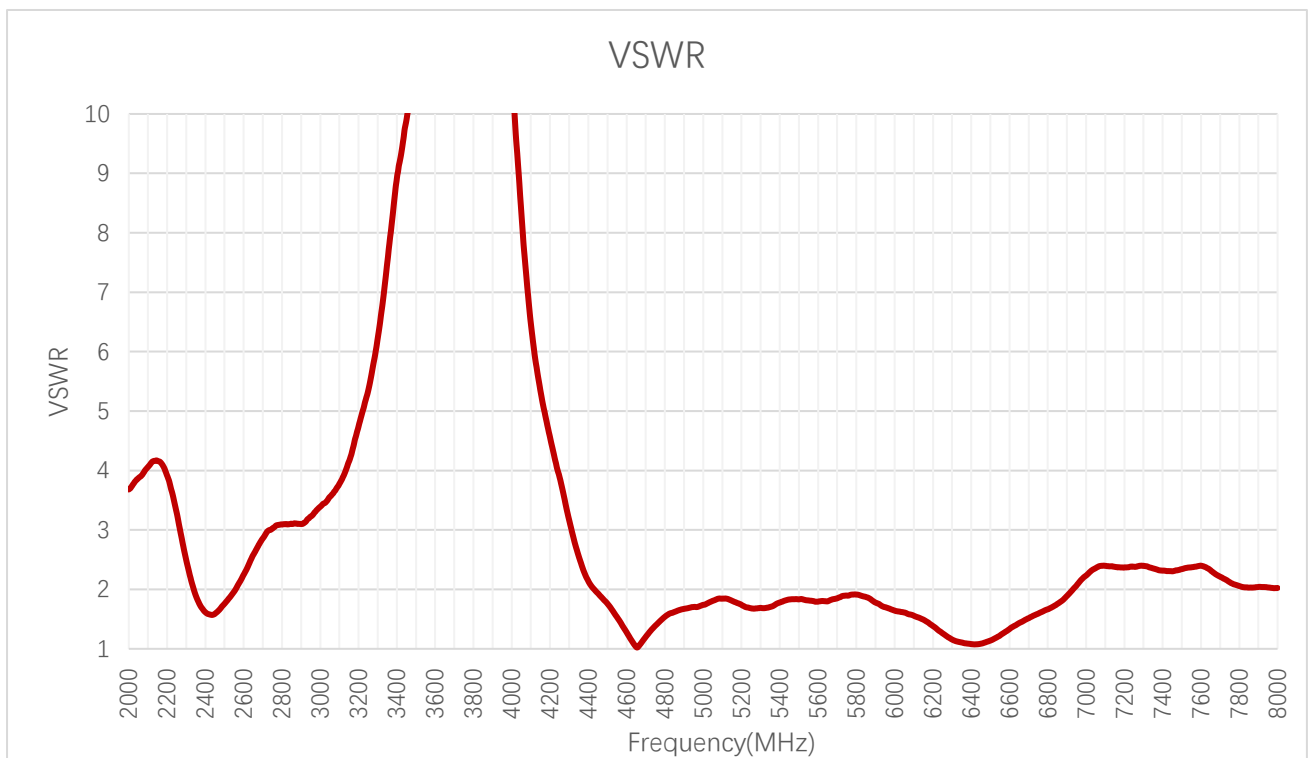

VSWR – Wi-Fi

Frequency (MHz)	2400	2450	2500	5150	5500	5850	5925	6325	6725	7125
VSWR	1.6	1.6	1.8	1.8	1.8	1.9	1.7	1.1	1.6	2.4

VSWR – V2X

Frequency (MHz)	5860	5880	5900
VSWR	1.9	1.8	1.8

3.1.2. Return Loss

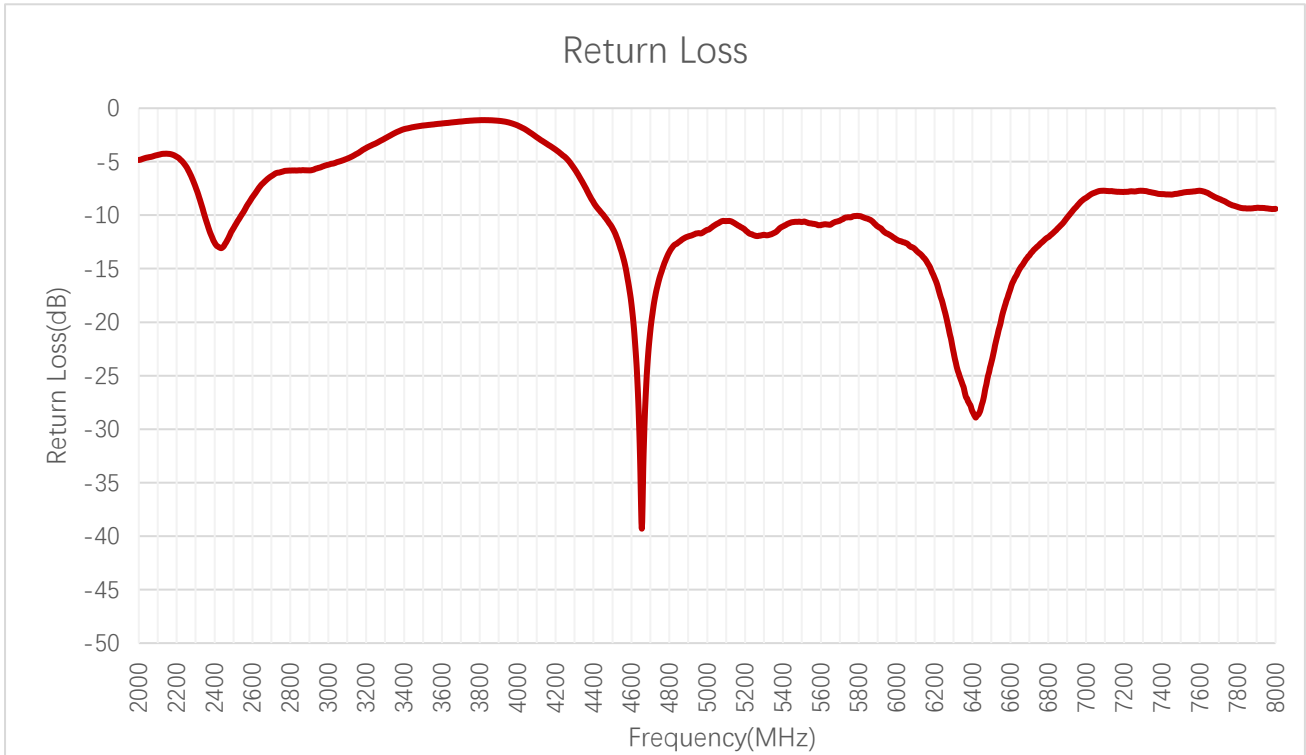

Return Loss (dB) – Wi-Fi

Frequency (MHz)	2400	2450	2500	5150	5500	5850	5925	6325	6725	7125
Return Loss (dB)	-12.6	-12.9	-11.1	-10.8	-10.6	-10.4	-11.4	-24.8	-13.2	-7.7

Return Loss (dB) – V2X

Frequency (MHz)	5860	5880	5900
Return Loss (dB)	-10.5	-10.7	-11.0

3.2. Radiation Performance Test

3.2.1. Efficiency

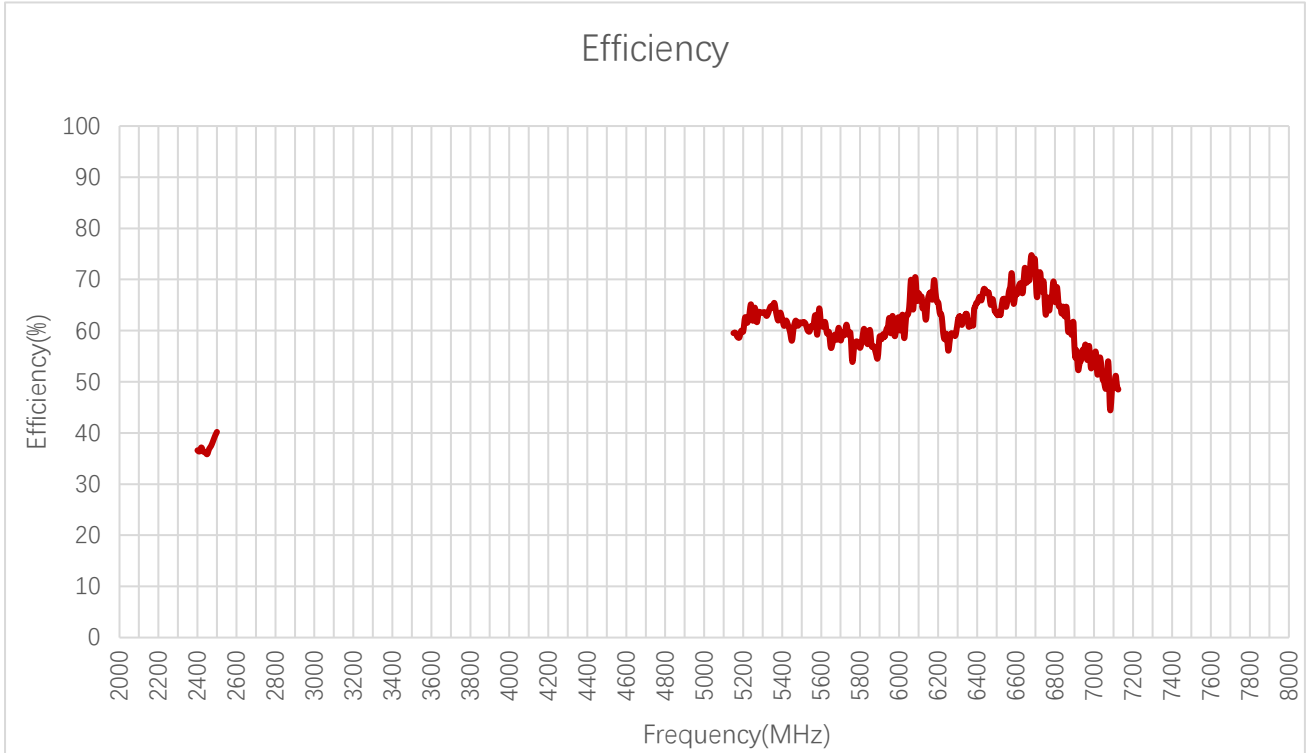

Efficiency (%) – Wi-Fi

Frequency (MHz)	2400	2450	2500	5150	5500	5850	5925	6325	6725	7125
Efficiency (%)	36.6	35.9	40.2	59.5	61.4	60.2	58.9	61.5	71.3	48.5

Efficiency (%) – V2X

Frequency (MHz)	5860	5880	5900
Efficiency (%)	56.9	55.7	58.9

3.2.2. Average Gain

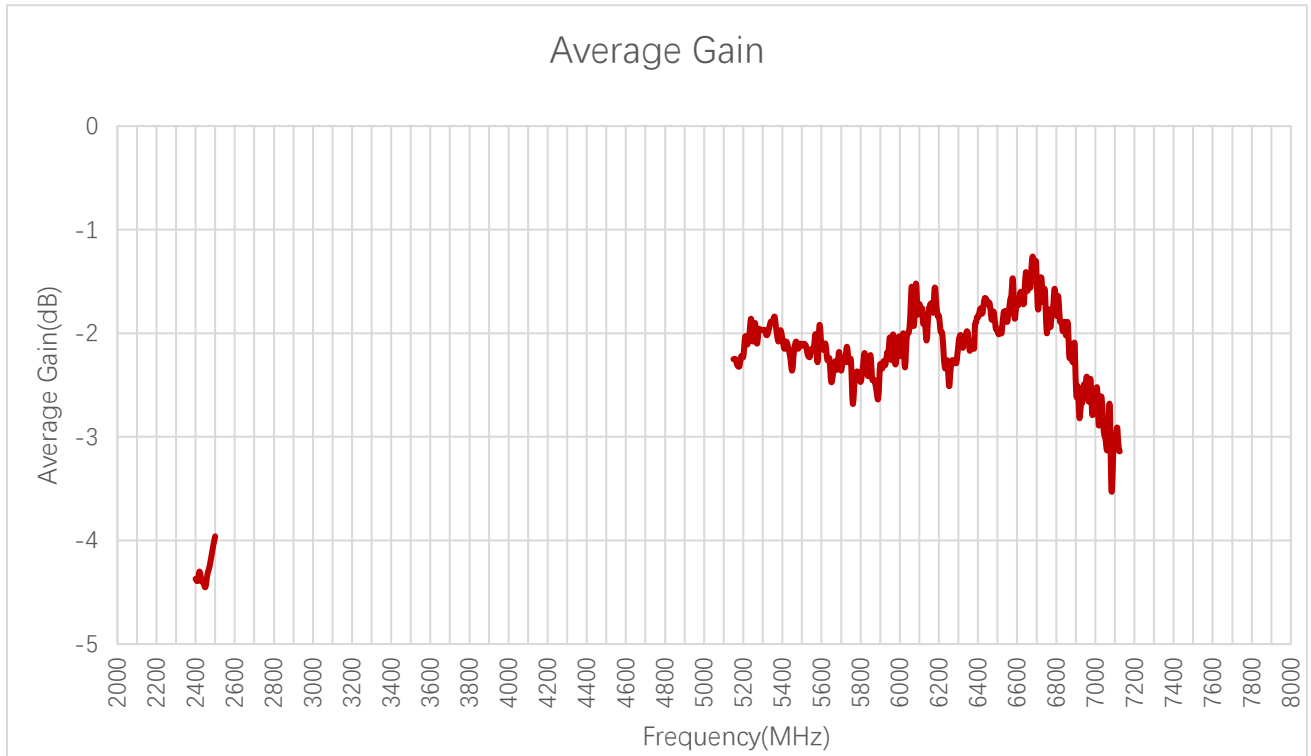

Average Gain (dB) – Wi-Fi

Frequency (MHz)	2400	2450	2500	5150	5500	5850	5925	6325	6725	7125
Average Gain (dB)	-4.4	-4.5	-4.0	-2.3	-2.1	-2.2	-2.3	-2.1	-1.5	-3.1

Average Gain (dB) – V2X

Frequency (MHz)	5860	5880	5900
Average Gain (dB)	-2.5	-2.5	-2.3

3.2.3. Peak Gain

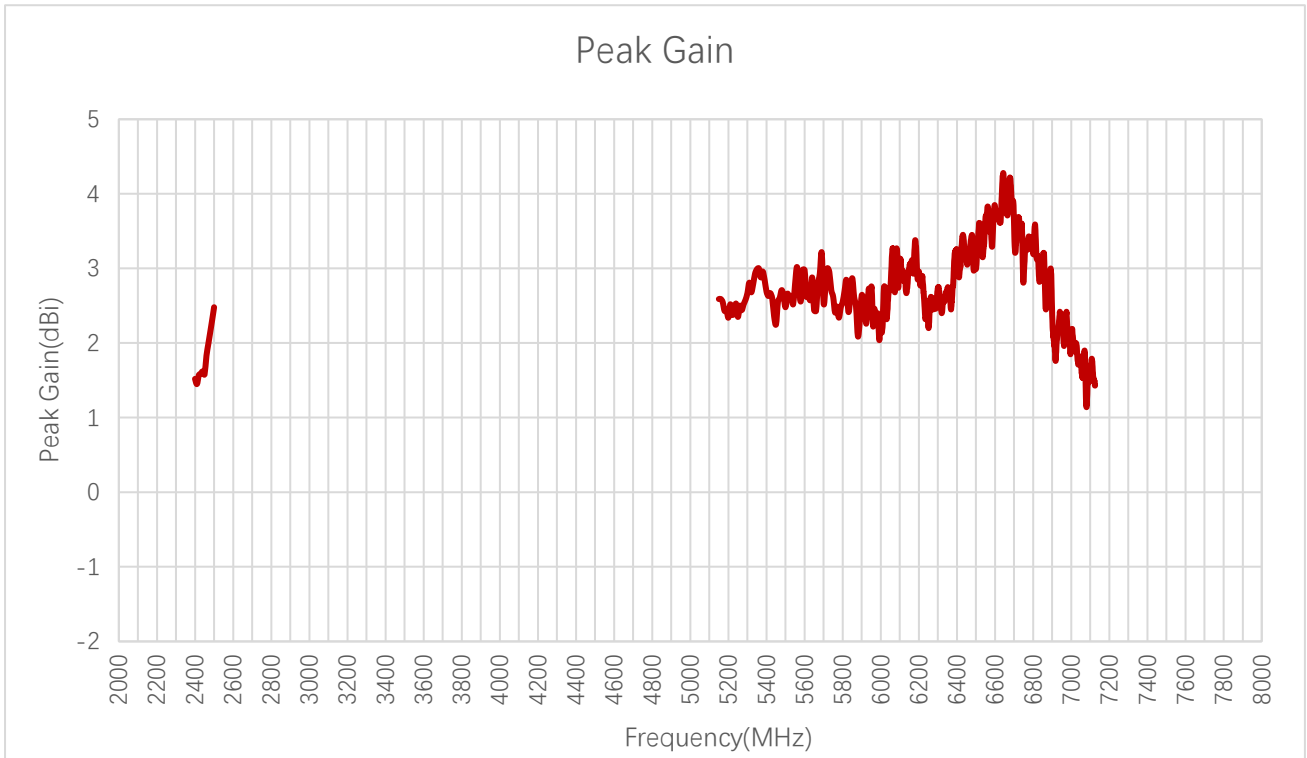

Peak Gain (dBi) – Wi-Fi

Frequency (MHz)	2400	2450	2500	5150	5500	5850	5925	6325	6725	7125
Peak Gain (dBi)	1.5	1.6	2.5	2.6	2.5	2.9	2.3	2.5	3.7	1.4

Peak Gain (dBi) – V2X

Frequency (MHz)	5860	5880	5900
Peak Gain (dBi)	2.6	2.1	2.6

3.2.4. 3D & 2D Radiation Pattern

- Test Condition: On 130 mm × 70 mm EVB
- Test Chamber: GL-G-1

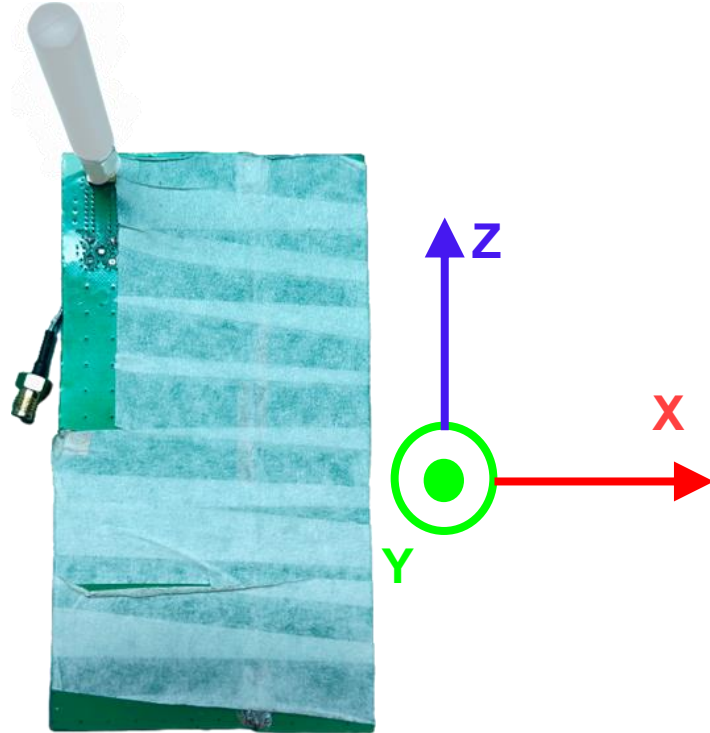

● **Wi-Fi**

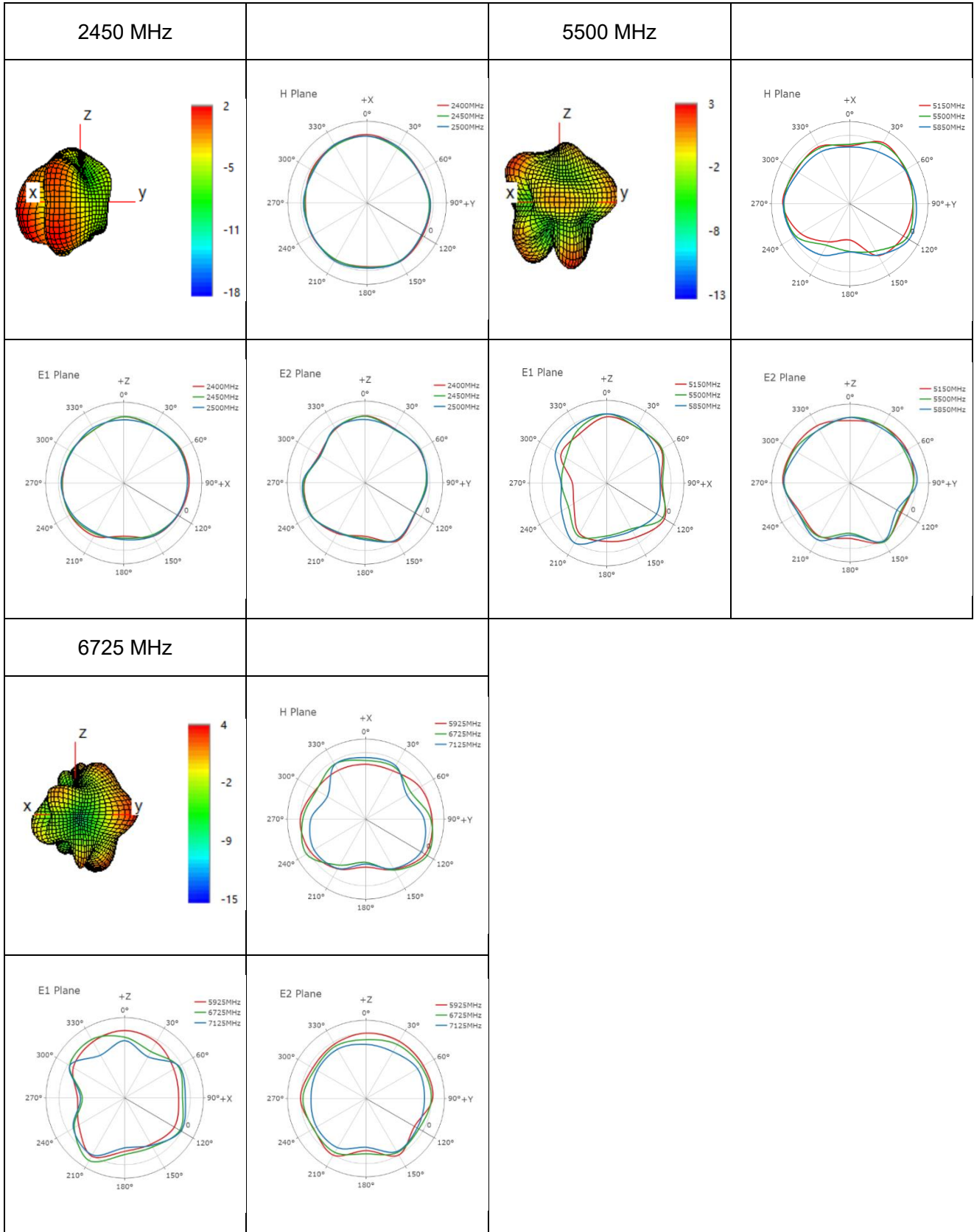

● **V2X**

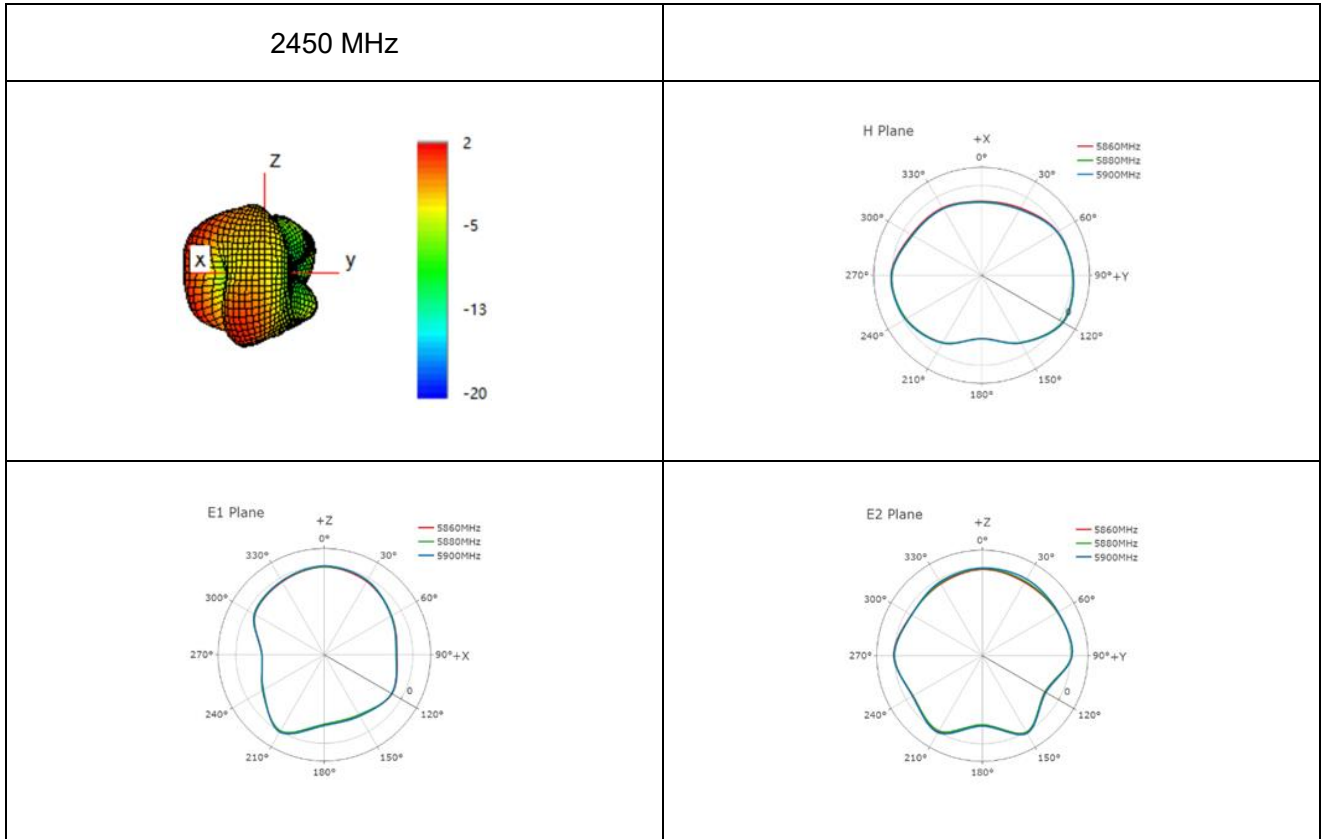

4 Packaging

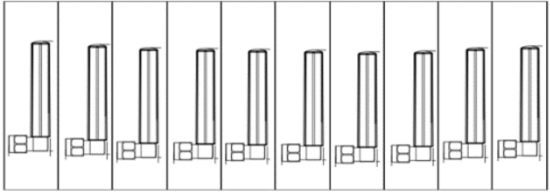
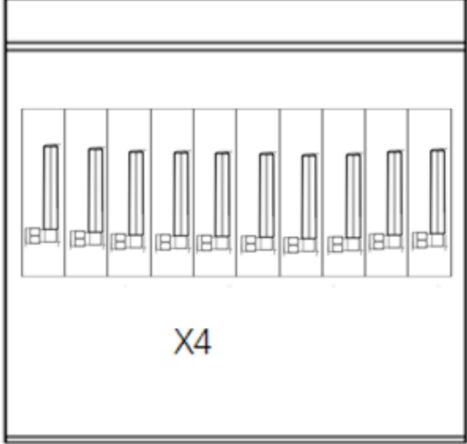
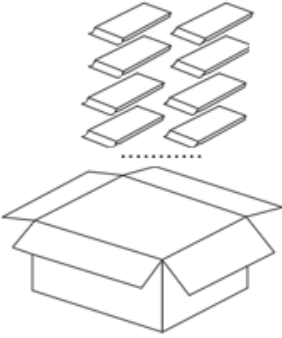
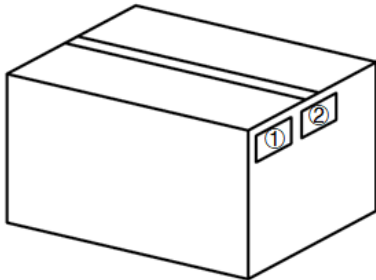
Step	Packaging Picture / 2D Picture	Description
1		<p>10 antenna products in a one-piece bag. (10 Antennas / One-piece Bag)</p>
2		<p>40 antenna products in a PE bag. (40 Antennas / PE Bag)</p>
3		<p>(25 PE Bags / Carton Box) (1000 Antennas / Carton Box) Estimated quantity Products that cannot fill the entire carton box are packed in a suitable size carton box. <u>Carton Size:</u> <u>L × W × H = 405 × 293 × 185 mm</u></p>
4		<p>Position for Attaching Labels</p> <ul style="list-style-type: none"> ① Carton Label ② Quality Label

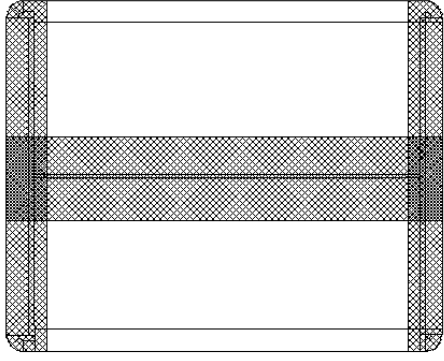
5	 A technical drawing of an H-shaped sealing carton. It consists of a central horizontal rectangular section with a cross-hatched texture, flanked by two vertical rectangular sections, also with a cross-hatched texture. The corners of the vertical sections are rounded. The entire structure is shown in a perspective view.	Sealing Cartons H-shaped sealing cartons
Note	The initial packaging method described above is for reference only, and the final actual packaging method shall be subject to the actual shipping packaging.	

Contact Us

At Quectel, our aim is to provide timely and comprehensive services to our customers. If you require any assistance, please contact our headquarters:

Quectel Wireless Solutions Co., Ltd.

Building 5, Shanghai Business Park Phase III (Area B), No.1016 Tianlin Road, Minhang District, Shanghai 200233, China

Tel: +86 21 5108 6236

Email: info@quectel.com

Or our local offices. For more information, please visit:

<http://www.quectel.com/support/sales.htm>.

For technical support, or to report documentation errors, please visit:

<http://www.quectel.com/support/technical.htm>.

Or email us at: support@quectel.com.

Legal Notices

We offer information as a service to you. The provided information is based on your requirements and we make every effort to ensure its quality. You agree that you are responsible for using independent analysis and evaluation in designing intended products, and we provide reference designs for illustrative purposes only. Before using any hardware, software or service guided by this document, please read this notice carefully. Even though we employ commercially reasonable efforts to provide the best possible experience, you hereby acknowledge and agree that this document and related services hereunder are provided to you on an “as available” basis. We may revise or restate this document from time to time at our sole discretion without any prior notice to you.

Use and Disclosure Restrictions

License Agreements

Documents and information provided by us shall be kept confidential, unless specific permission is granted. They shall not be accessed or used for any purpose except as expressly provided herein.

Copyright

Our and third-party products hereunder may contain copyrighted material. Such copyrighted material shall not be copied, reproduced, distributed, merged, published, translated, or modified without prior written consent. We and the third party have exclusive rights over copyrighted material. No license shall be granted or conveyed under any patents, copyrights, trademarks, or service mark rights. To avoid ambiguities, purchasing in any form cannot be deemed as granting a license other than the normal non-exclusive, royalty-free license to use the material. We reserve the right to take legal action for noncompliance with abovementioned requirements, unauthorized use, or other illegal or malicious use of the material.

Trademarks

Except as otherwise set forth herein, nothing in this document shall be construed as conferring any rights to use any trademark, trade name or name, abbreviation, or counterfeit product thereof owned by Quectel or any third party in advertising, publicity, or other aspects.

Third-Party Rights

This document may refer to hardware, software and/or documentation owned by one or more third parties (“third-party materials”). Use of such third-party materials shall be governed by all restrictions and obligations applicable thereto.

We make no warranty or representation, either express or implied, regarding the third-party materials, including but not limited to any implied or statutory, warranties of merchantability or fitness for a particular purpose, quiet enjoyment, system integration, information accuracy, and non-infringement of any third-party intellectual property rights with regard to the licensed technology or use thereof. Nothing herein constitutes a representation or warranty by us to either develop, enhance, modify, distribute, market, sell, offer for sale, or otherwise maintain production of any our products or any other hardware, software, device, tool, information, or product. We moreover disclaim any and all warranties arising from the course of dealing or usage of trade.

Privacy Policy

To implement module functionality, certain device data are uploaded to Quectel's or third-party's servers, including carriers, chipset suppliers or customer-designated servers. Quectel, strictly abiding by the relevant laws and regulations, shall retain, use, disclose or otherwise process relevant data for the purpose of performing the service only or as permitted by applicable laws. Before data interaction with third parties, please be informed of their privacy and data security policy.

Disclaimer

- a) We acknowledge no liability for any injury or damage arising from the reliance upon the information.
- b) We shall bear no liability resulting from any inaccuracies or omissions, or from the use of the information contained herein.
- c) While we have made every effort to ensure that the functions and features under development are free from errors, it is possible that they could contain errors, inaccuracies, and omissions. Unless otherwise provided by valid agreement, we make no warranties of any kind, either implied or express, and exclude all liability for any loss or damage suffered in connection with the use of features and functions under development, to the maximum extent permitted by law, regardless of whether such loss or damage may have been foreseeable.
- d) We are not responsible for the accessibility, safety, accuracy, availability, legality, or completeness of information, advertising, commercial offers, products, services, and materials on third-party websites and third-party resources.

Copyright © Quectel Wireless Solutions Co., Ltd. 2025. All rights reserved.

Revision History

Version	Date	Author	Note
-	2025-10-15	Mayes Li/ Steven Mo/ Strong Qiang/ Rainey Liao	Creation of the document
1.0	2025-10-15	Mayes Li/ Steven Mo/ Strong Qiang/ Rainey Liao	First official release

QUECTEL

www.quectel.com